

Sealed Stainless Steel Ball Float Steam Traps
for use with Pipeline Connectors
Installation and Maintenance Instructions

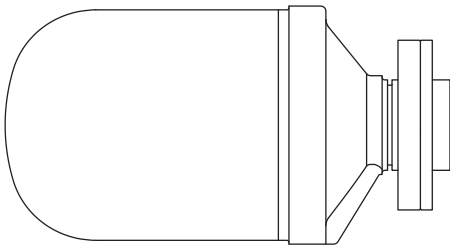

1. Safety information
2. General product information
3. Installation
4. Commissioning
5. Operation
6. Maintenance
7. Spare parts

1. Safety information

Safe operation of these products can only be guaranteed if they are properly installed, commissioned, used and maintained by qualified personnel (see Section 1.11) in compliance with the operating instructions. General installation and safety instructions for pipeline and plant construction, as well as the proper use of tools and safety equipment must also be complied with.

1.1 Intended use

Referring to the Installation and Maintenance Instructions, name-plate and Technical Information Sheet, check that the product is suitable for the intended use/application. These products comply with the requirements of the Pressure Equipment Directive (PED) and all fall within category 'SEP'. It should be noted that products within this category are required by the Directive not to carry the  mark.

- i) These products have been specifically designed for use on steam, air or condensate/water, which is in Group 2 of the above mentioned Pressure Equipment Directive.
The products' use on other fluids may be possible but, if this is contemplated, Spirax Sarco should be contacted to confirm the suitability of the product for the application being considered.
- ii) Check material suitability, pressure and temperature and their maximum and minimum values. If the maximum operating limits of the product are lower than those of the system in which it is being fitted, or if malfunction of the product could result in a dangerous overpressure or overtemperature occurrence, ensure a safety device is included in the system to prevent such over-limit situations.
- iii) Determine the correct installation situation and direction of fluid flow.
- iv) Spirax Sarco products are not intended to withstand external stresses that may be induced by any system to which they are fitted. It is the responsibility of the installer to consider these stresses and take adequate precautions to minimise them.
- v) Remove protection covers from all connections and protective film from all name-plates, where appropriate, before installation on steam or other high temperature applications.

1.2 Access

Ensure safe access and if necessary a safe working platform (suitably guarded) before attempting to work on the product. Arrange suitable lifting gear if required.

1.3 Lighting

Ensure adequate lighting, particularly where detailed or intricate work is required.

1.4 Hazardous liquids or gases in the pipeline

Consider what is in the pipeline or what may have been in the pipeline at some previous time. Consider: flammable materials, substances hazardous to health, extremes of temperature.

1.5 Hazardous environment around the product

Consider: explosion risk areas, lack of oxygen (e.g. tanks, pits), dangerous gases, extremes of temperature, hot surfaces, fire hazard (e.g. during welding), excessive noise, moving machinery.

1.6 The system

Consider the effect on the complete system of the work proposed. Will any proposed action (e.g. closing isolation valves, electrical isolation) put any other part of the system or any personnel at risk?

Dangers might include isolation of vents or protective devices or the rendering ineffective of controls or alarms. Ensure isolation valves are turned on and off in a gradual way to avoid system shocks.

1.7 Pressure systems

Ensure that any pressure is isolated and safely vented to atmospheric pressure. Consider double isolation (double block and bleed) and the locking or labelling of closed valves. Do not assume that the system has depressurised even when the pressure gauge indicates zero.

1.8 Temperature

Allow time for temperature to normalise after isolation to avoid danger of burns.

1.9 Tools and consumables

Before starting work ensure that you have suitable tools and/or consumables available. Use only genuine Spirax Sarco replacement parts.

1.10 Protective clothing

Consider whether you and/or others in the vicinity require any protective clothing to protect against the hazards of, for example, chemicals, high/low temperature, radiation, noise, falling objects, and dangers to eyes and face.

1.11 Permits to work

All work must be carried out or be supervised by a suitably competent person. Installation and operating personnel should be trained in the correct use of the product according to the Installation and Maintenance Instructions.

Where a formal 'permit to work' system is in force it must be complied with. Where there is no such system, it is recommended that a responsible person should know what work is going on and, where necessary, arrange to have an assistant whose primary responsibility is safety. Post 'warning notices' if necessary.

1.12 Handling

Manual handling of large and/or heavy products may present a risk of injury. Lifting, pushing, pulling, carrying or supporting a load by bodily force can cause injury particularly to the back. You are advised to assess the risks taking into account the task, the individual, the load and the working environment and use the appropriate handling method depending on the circumstances of the work being done.

1.13 Residual hazards

In normal use the external surface of the product may be very hot. If used at the maximum permitted operating conditions the surface temperature of some products may reach temperatures of 400 °C (752 °F).

Many products are not self-draining. Take due care when dismantling or removing the product from an installation (refer to 'Maintenance instructions').

1.14 Freezing

Provision must be made to protect products which are not self-draining against frost damage in environments where they may be exposed to temperatures below freezing point.

1.15 Disposal

Unless otherwise stated in the Installation and Maintenance Instructions, this product is recyclable and no ecological hazard is anticipated with its disposal providing due care is taken.

1.16 Returning products

Customers and stockists are reminded that under EC Health, Safety and Environment Law, when returning products to Spirax Sarco they must provide information on any hazards and the precautions to be taken due to contamination residues or mechanical damage which may present a health, safety or environmental risk. This information must be provided in writing including Health and Safety data sheets relating to any substances identified as hazardous or potentially hazardous.

2. General product information

2.1 General description

The UFT32 is an austenitic stainless steel maintenance free sealed ball float steam trap with an integral automatic air venting facility. It is designed for differential steam pressures up to 32 bar.

When installed with a suitable pipeline connector the UFT32 can easily and simply be removed without breaking into the pipeline, thus speeding up trap replacement with minimal system downtime. Pipeline connectors are available with screwed, socket weld and flanged end connections.

Standards

The body to cover welded joint complies with ASME Section IX and BS/EN 288.

This product fully complies with the requirements of the Pressure Equipment Directive (PED).

Certification

This product is available with certification to EN 10204 3.1.

Note: All certification/inspection requirements must be stated at the time of order placement.

Note:

For additional information see the following Technical Information Sheet: UFT32 TI-P146-05.

2.2 Sizes and pipe connections

The UFT32 can be fitted to a variety of pipeline connectors including:

| | | | |
|----------------|--|----------|--------------|
| PC10HP | Straight connector | ASME 600 | (TI-P128-10) |
| PC20 | Straight connector with 'Y' type strainer | ASME 300 | (TI-P128-15) |
| IPC21 | Straight connector with 'Y' type strainer and integral Spiratec sensor | ASME 300 | (TI-P128-15) |
| PC3_ | Straight connector with one piston isolation valve | ASME 600 | (TI-P128-02) |
| PC4_ | Straight connector with two piston isolation valves | ASME 600 | (TI-P128-03) |
| STS17.2 | Steam trap station | | (TI-P128-22) |

See the relevant Technical Information sheet as listed above for details of the connections available for each pipeline connector.

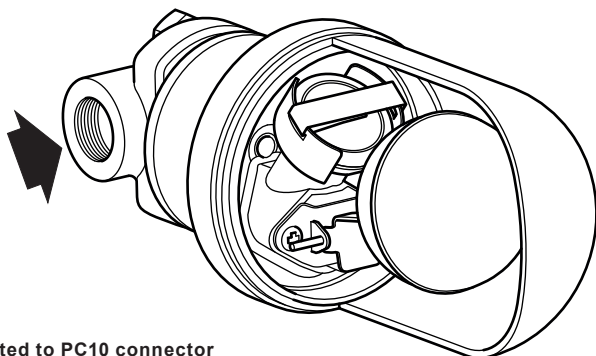

Fig. 1 UFT fitted to PC10 connector

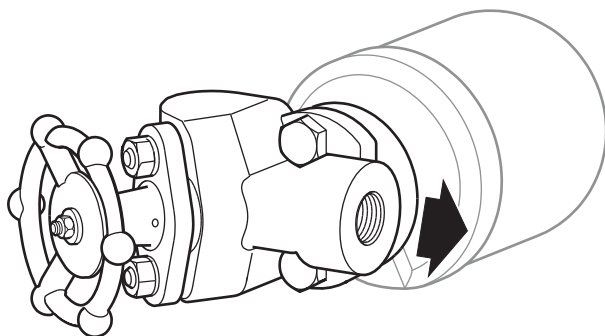

Fig. 2 UFT fitted to PC3_connector

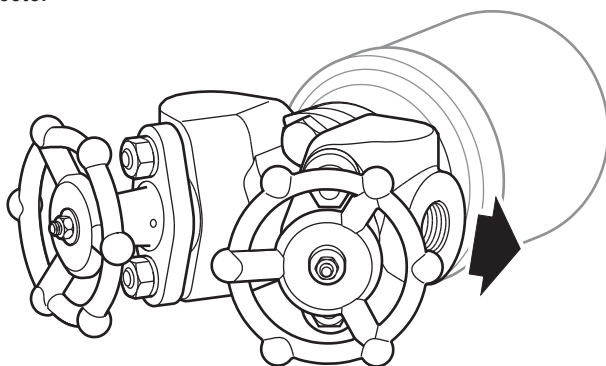
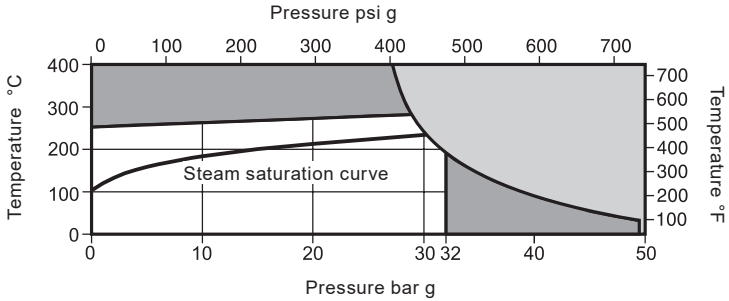



Fig. 3 UFT fitted to PC4_connector

2.3 Pressure/ temperature limits (ISO 6552)



 The product **must not** be used in this region.

 The product should not be used in this region or beyond its operating range as damage to the internals may occur.

Note: The model of pipeline connector and connections selected will dictate the maximum operating pressure and temperature of the complete assembly. Consult the relevant Technical Information Sheet, as listed in Section 2.2, for this information.

| | | | |
|--|--|--------------------------|---------------------|
| Body design conditions | | PN50 | (ASME / ANSI 300) |
| PMA | Maximum allowable pressure | 50 bar g @ 38 °C | (725 psi g @ 100°F) |
| TMA | Maximum allowable temperature | 400 °C @ 28 bar g | (752°F @ 406 psi g) |
| | Minimum allowable temperature | -48 °C | (-54°F) |
| PMO | Maximum operating pressure for saturated steam service | 32 bar g | (464 psi g) |
| TMO | Maximum operating temperature | 286 °C @ 29 bar g | (547°F @ 420 psi g) |
| | Minimum operating temperature | 0 °C | (32°F) |
| Note: For lower operating temperatures consult Spirax Sarco | | | |
| | | UFT32-4.5 4.5 bar | UFT32-4.5 (65 psi) |
| | | UFT32-10 10 bar | UFT32-10 (145 psi) |
| ΔPMX | Maximum differential pressure | UFT32-14 14 bar | UFT32-14 (203 psi) |
| | | UFT32-21 21 bar | UFT32-21 (305 psi) |
| | | UFT32-32 32 bar | UFT32-32 (464 psi) |
| | | | |
| Designed for a maximum cold hydraulic test pressure of: | | 50 bar g | (725 psi g) |

3. Installation

Note: Before actioning any installation observe the 'Safety information' in Section 1.

Referring to the Installation and Maintenance Instructions, name-plate and Technical Information Sheet, check that the product is suitable for the intended installation:

- 3.1** Check materials, pressure and temperature and their maximum values. If the maximum operating limit of the product is lower than that of the system in which it is being fitted, ensure that a safety device is included in the system to prevent overpressurisation.
- 3.2** Determine the correct installation situation and the direction of fluid flow.
- 3.3** Remove protective covers from all connections and protective film from all name-plates, where appropriate, before installation on steam or other high temperature applications.
- 3.4** The UFT32 can be installed on any pipeline connector, but must be installed in a horizontal plane with the 'TOP' label facing upwards.
See separate Installation and Maintenance Instructions for Spirax Sarco pipeline connectors (IM-P128-06, IM-P128-11 and IM-P128-13).
Ensure that both gaskets are clean and undamaged and that the transfer holes are clear. Place the UFT32 body against the connector gasket face, ensuring that the label 'TOP' is uppermost and the trap itself is horizontal.
Ensuring the new connector screws supplied with the trap are used, apply a small amount of anti-seize compound to the threads of the connector screws (3).
Tighten the screws finger tight until the mating gasket faces are in parallel, intimate contact. Tighten the screws to the recommended torque value (see Table 1).
Open isolation valves slowly until normal operating conditions are achieved.
- 3.5** Check for leaks.

Note: If the trap is to discharge to atmosphere ensure it is a safe place, the discharging fluid may be at a temperature of 100 °C (212 °F).

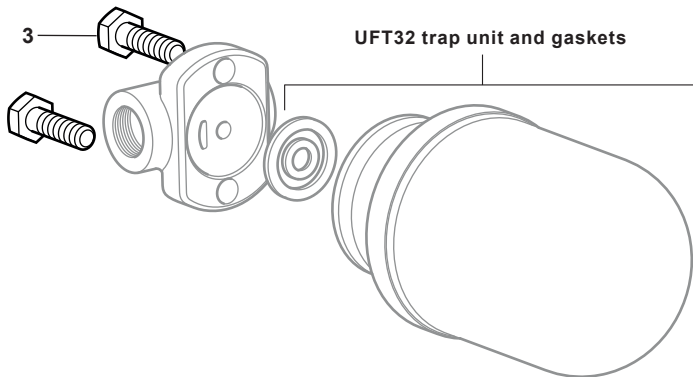



Fig. 4

Table 1 Recommended tightening torques

| Item | Part |  or  | N m | (lbf ft) |
|------|------------------|--|---------|-----------|
| 3 | Connector screws | 3/16" A/F | 30 - 35 | (22 - 26) |

4. Commissioning

After installation or maintenance ensure that the system is fully functioning. Carry out tests on any alarms or protective devices.

5. Operation

The float trap is a continuous discharge trap, removing condensate the instant it forms. On start-up, the thermostatic air vent allows air to bypass the main valve preventing the system air binding. Hot condensate will close the air vent tightly, but as soon as it enters the main chamber of the trap, the float rises and the lever mechanism attached to it opens the main valve - keeping the system drained of condensate at all times. When steam arrives, the float drops and closes the main valve. Float traps are renowned for their high start-up load handling capability, clean tight shut-off and resistance to waterhammer and vibration.

6. Maintenance

Note: Before actioning any maintenance programme observe the 'Safety information' in Section 1.

Warning

The inner and outer gaskets used when installing/maintaining the UFT32 to a PC_ pipeline connector contain thin stainless steel support rings which may cause physical injury if not handled and disposed of carefully.

6.1 General information

Before undertaking any maintenance on the trap it must be isolated from both the supply line and return line and any pressure allowed to safely normalise to atmosphere. The trap should then be allowed to cool. When reassembling, ensure that all joint faces are clean.

6.2 Replacement of the trap unit:

- Ensure that the correct tools and necessary protective equipment are used at all times.
- Replacement of the trap unit is achieved by removing the two connector screws (3) and removing the trap.
- Always use new connector screws, as supplied with the new trap, when replacing a universal trap.
- The new trap unit should be positioned against the connector gasket face and apply a small amount of anti-seize compound to the threads of the connector screws.
- Tighten screws finger tight and ensure that the trap body is parallel to the connector.
- Tighten the screws to the recommended torque (see Table 1).
- Open isolation valves slowly until normal operating conditions are achieved.
- Check for leaks.

7. Spare parts

The UFT32 is a sealed non-maintainable trap unit. No internal spares are available. The spares which are available are shown in heavy outline. Parts shown in a grey line are not supplied as spares.

Available spares

Connector screws (x 2) 3

Complete UFT32 trap unit inclusive of gaskets and connector screws (3)

Note: Specify the model number and differential pressure of the trap, eg, UFT32-4.5.

How to order spares

Always order spare parts by using the description given in the column headed 'Available spares' and state the size, model no. and pressure rating of the trap.

Example:

2 off connector screws for a Spirax Sarco UFT32 sealed stainless steel ball float steam trap (for use with pipeline connectors).

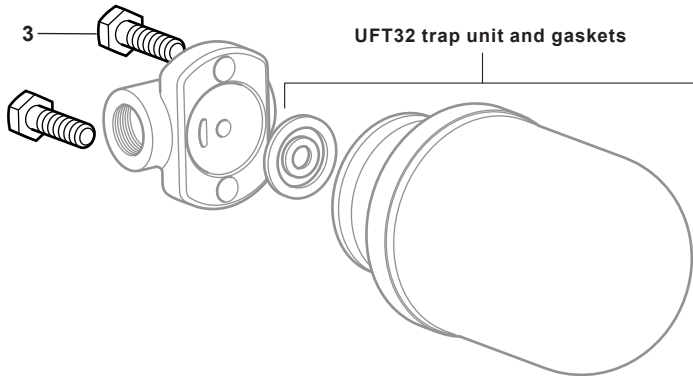



Fig. 5

Table 1 Recommended tightening torques

| Item | Part |  or  | N m | (lbf ft) |
|------|------------------|--|---------|-----------|
| 3 | Connector screws | 9/16" A/F | 30 - 35 | (22 - 26) |

