

## VLM30-S and VLM30-E Vortex Flowmeter

### Quick Start Guide – Steam Applications

---

---



#### Device firmware version:

- 03.00.xx (HART)
- 02.00.xx (Modbus)

# Contents

1. Safety information
2. Transport & storage
3. Installation
4. Electrical connections
5. Commissioning

# 1. Safety information

Safe operation of these products can only be guaranteed if they are properly installed, commissioned, used and maintained by qualified personnel (see VLM30-S and VLM30-E Installation manual IM-P736-02) in compliance with the operating instructions. General installation and safety instructions for pipeline and plant construction, as well as the proper use of tools and safety equipment must also be complied with.

This device has been designed for use exclusively within the technical limit values indicated on the identification plate and in the data sheets.

When using measuring media, the following points must be observed:

- Measuring media may only be used if it can be assured that the chemical and physical properties necessary for operational security of the materials of the wetted parts of the flowmeter sensor will not be adversely affected during the operating time.
- Media containing chloride can cause corrosion damage to stainless steels which, although not visible externally, can damage wetted parts beyond repair and lead to the measuring medium escaping. It is the operator's responsibility to check the suitability of these materials for the respective application.
- Measuring media with unknown properties or abrasive measuring media may only be used if the operator is able to perform regular and suitable tests to ensure the safe condition of the device.

## Improper use

The following are instances of especially improper use of the device:

- Operation as a flexible compensating adapter in piping, for example for compensating pipe offsets, pipe vibrations, pipe expansions, etc.
- For use as a climbing aid, for example for mounting purposes.
- For use as a bracket for external loads, for example as a support for piping, etc.
- Material application, for example by painting over the housing, name plate or welding/soldering on parts.
- Material removal, for example by spot drilling the housing.

## 2. Transport and Storage

### 2.1 Inspection

Check devices after unpacking to ensure they are undamaged. Any damage found must be submitted to the shipper immediately and before any installation.



**Danger!** Do not stand under suspended loads

**Risk of Injury!** Support the devices laterally during transport

**Ensure devices do not slip or turn during transport**

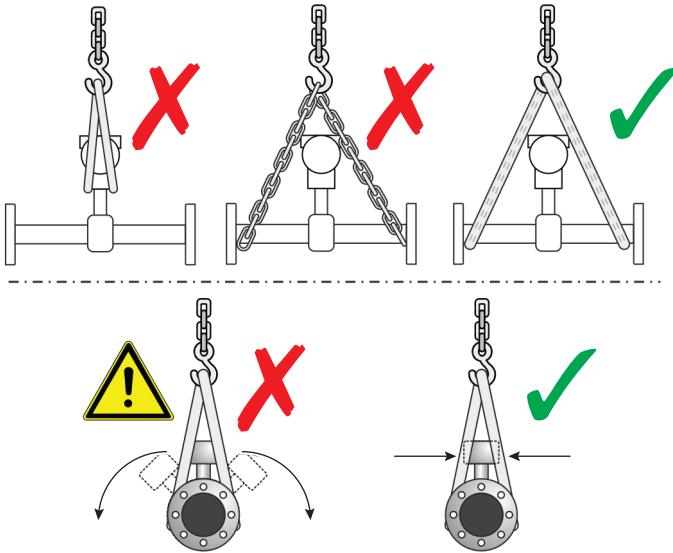

Fig. 1

## 2.2 Flange devices $\leq$ DN 300

- Use carrying straps to transport devices.
- Wrap the carrying straps around both process connections. Do not use chains should not be used to prevent damage to the housing.

## 2.3 Flange devices $>$ DN 300

- Take care using a forklift to transport flange devices to avoid housing damage.
- Flange devices must not be lifted by the centre of the housing.
- Flange devices must not be lifted by the terminal box.
- Only the transport lugs fitted to the device can be used to lift the device for insertion into a pipeline.

## 2.4 Storing the device

Store the device in its original packaging in a dry and dust-free location.

- Observe the permitted ambient conditions for transport and storage.
- Avoid storing the device in direct sunlight.
- In principle, the devices may be stored for an unlimited period. However, the warranty conditions stipulated in the order confirmation of the supplier apply.

## 2.5 Ambient conditions

The ambient conditions for the transport and storage of the device correspond to the ambient conditions for operation of the device (below)

### 2.6 Ambient temperature range

Standard	High Temp
-20 to 85 °C (-4 to 185 °F)	-40 to 85 °C (-40 to 185 °F)

### 2.7 Relative humidity

Standard	Maximum 85 %, annual average $\leq$ 65 %
----------	--

# 3. Installation

A Vortex flowmeter may be installed at any point in the pipeline system. However, the following installation / operating conditions must be considered:

- Compliance to the device min/max ambient and min/max medium temperatures.
- Compliance with the recommended inlet and outlet sections.
- The flow direction must correspond to that indicated by the arrow on the sensor.
- Mitigation of mechanical vibrations of the piping (fitting supports if necessary).
- The inside diameter of the sensor and the piping must be identical.
- Avoidance of pressure oscillations in long piping systems at zero flow.
- Avoid pulsating flow.
- Fit valves or gates downstream of the flowmeter (typically: 3 × DN).
- For piston, plunger pumps or compressors, hydraulic vibration in the pipeline may occur at zero flow. In such cases installation of an isolation valve upstream of the flowmeter and / or install suitable damping devices.
- Ensure the flow sensor is always filled with the measured medium.

### 3.1 Inlet and outlet sections

To maximize operational stability, distortion to the flow profile on entry to the flowmeter should be minimised. We recommended the following guideline inlet and outlet sections for various installations: -

#### 3.1.1 Straight Pipe Sections

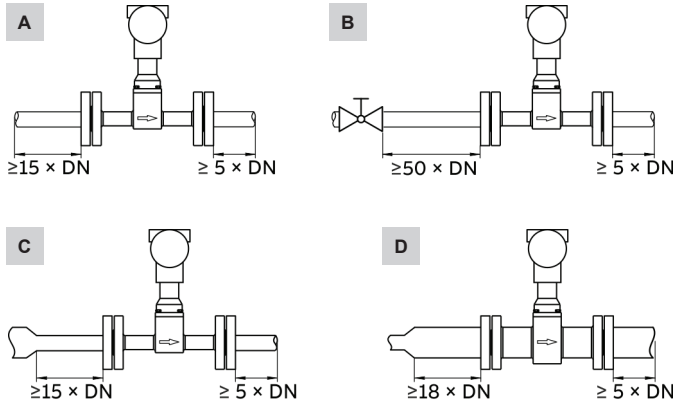

Fig. 2

Installation	Inlet Section	Outlet Section
<b>A</b> Straight pipe section	min. 15 x DN	min. 5 x DN
<b>B</b> Valve upstream of meter	min. 50 x DN	min. 5 x DN
<b>C</b> Pipe reduction	min. 15 x DN	min. 5 x DN
<b>D</b> Pipe extension	min. 18 x DN	min. 5 x DN

### 3.1.2 Pipe section with elbows

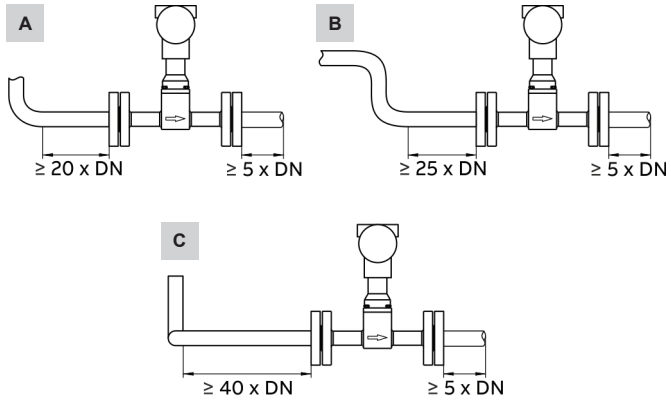

Fig. 3

Installation	Inlet Section	Outlet Section
<b>A</b> Single pipe elbow	min. 20 x DN	min. 5 x DN
<b>B</b> Valve upstream of meter	min. 25 x DN	min. 5 x DN
<b>C</b> Three-dimensional pipe elbow	min. 40 x DN	min. 5 x DN

### 3.2 Avoiding cavitation

To avoid cavitation, a static overpressure is necessary downstream of the flowmeter. The required pressure can be estimated using the following formula:

$$p_1 \geq 1.3 \times p_2 = 2.6 \times \Delta p^d$$

$p_1$  = static gauge pressure

$p_2$  = pressure of fluid at operating temperature

$\Delta p^d$  = pressure drop across the flow meter



### 3.3 Installation at high medium temperatures

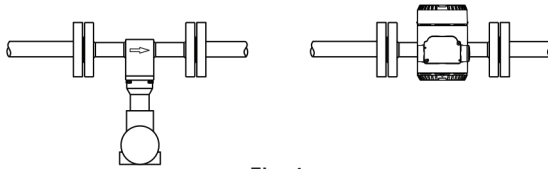

Fig. 4

At medium temperatures  $> 150\text{ }^{\circ}\text{C}$  ( $302\text{ }^{\circ}\text{F}$ ), the sensor must be installed so that the transmitter is pointing to the side or downward.

### 3.4 Installation of external pressure and temperature measurement

The flowmeter may be configured with an optional temperature measurement for applications such as a steam mass measurement. However, if pressure and temperature are to be compensated externally (e.g. using a flow computer unit), the measuring points must be installed as below:

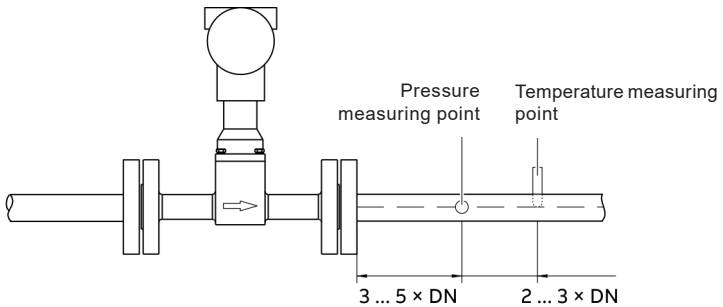

Fig. 5

### 3.5 Control and setting devices

Control elements should normally be installed at least 5 x DN downstream of the flowmeter. However, if the measured fluid is conveyed via piston pumps / peristaltic pumps or compressors, hydraulic vibrations may occur within the piping when valves are closed. In such cases it is acceptable to position the valve upstream of the flow meter, taking care to ensure there are sufficient pipe diameters before the flow meter to ensure a correct flow profile.

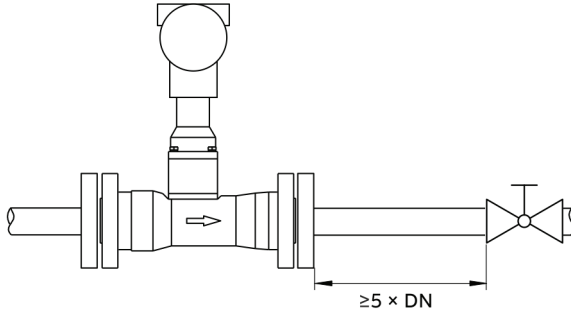

Fig. 6

### 3.6 Sensor Insulation

The VLM30 and piping may be insulated.

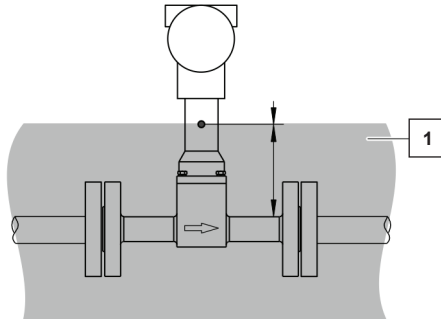

Fig. 7

Insulation must not under any circumstances be past the small hole in the sensor tower (1).



Take care to ensure that the VLM30 transmitter does not overheat.

Even with correct insulation, extreme conditions may occur if the transmitter is exposed to high ambient and high medium temperatures.

### 3.6 Use of trace heating.

Trace heating will not impair EMC protection or generate additional vibrations and is permitted under the following conditions:

- The trace heating is installed directly on or around the flow sensor.
- If installed inside insulation, the maximum insulation thickness must not exceed the maximum insulation depth (see previous image).
- Ambient conditions are observed to ensure the transmitter does not overheat.
- The flow meter is installed in accordance with EN 60079-14.

## 4. Electrical Connections



### Warning

Risk of injury due to live electrical connections

- Electrical connections should only be carried out by authorised and electrically trained personnel in accordance with the electrical diagrams.
- Only connect the device with the power supply switched off.
- Observe applicable electrical standards and site regulations

### 4.1 Signal cables

For remote design, the transmitter and sensor must be connected by a signal cable according to the following specification:

Cable specification	
Impedance	70 to 120 $\Omega$
Withstand voltage	500 V
Outer diameter (OD)	6 to 12 mm (0.24 to 0.47 in)
Cable design	3 x 2 x 0.75 mm <sup>2</sup> , twisted pair
Conductor cross section	0.75 mm <sup>2</sup>
Shield	Copper braid (85% coverage)
Temperature range	80 °C (176 °F) minimum
Maximum length	30 m (98 ft)

## 4.2 Installing the connection cables

Ensure that a drip loop (1) is used when connecting cables to the sensor. If mounting the sensor vertically, position the cable entries on the downward side of the transmitter. If necessary, rotate the transmitter housing accordingly.

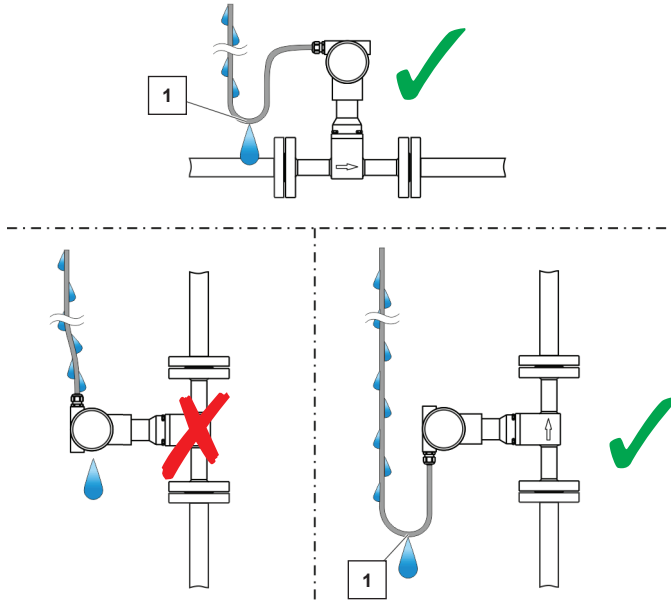

Fig. 8

## 4.3 Cable glands

All VLM30 flow meters are supplied with transport sealing plugs. The supplied sealing plugs do not have IP rating 4X / IP 67 and must be replaced with suitable cable glands or sealing plugs during device installation. When selecting the cable glands or sealing plugs, make sure they have the required IP rating. To guarantee IP rating 4X / IP67, the cable glands / sealing plugs must be screwed in using a suited sealing compound.

## 4.4 Grounding

	<b>Impact on measurement</b>
	The measurement may be impacted by external electric disruptions (EMC disruptions).
	- Ground the device as shown to avoid impact on the measurement by external electric disruptions (EMC disruptions)

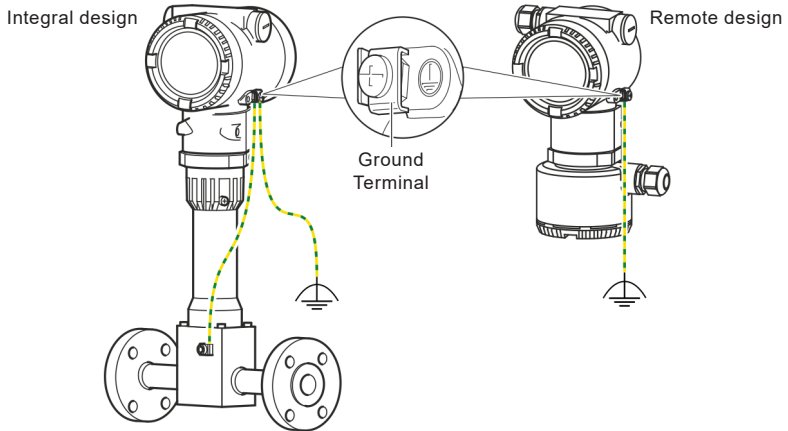
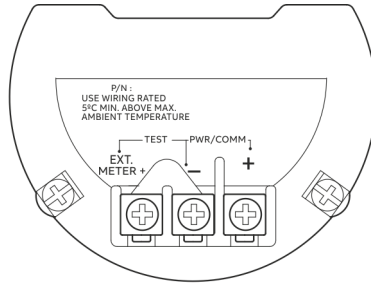

Fig. 9

To avoid potential differences, 3-point grounding (sensor, transmitter and earth) as shown above is recommended.

1. Loosen the screw terminal on the transmitter housing or on the housing of the VLM30
2. Insert the forked cable lug for functional grounding between the two metal tabs and into the loosened terminal.
3. Tighten the screw terminal.

**Power Supply / Signal Connections (4-20mA / HART)**



**Fig. 10**

The standard VLM30-S is a 2-wire, 4-20mA, loop powered device

Terminal	Function
PWR/COMM +	Power supply, current output / HART output
PWR/COMM -	Power supply, current output / HART output
EXT. METER	Not assigned

Additional options (analog outputs & digital inputs) may be available if selected, for the VLM30-E

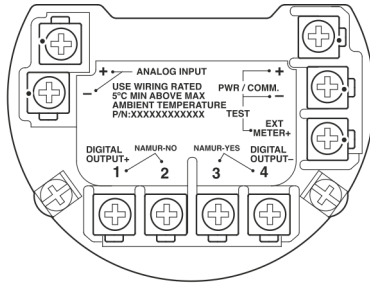

Fig. 11

Terminal	Function
PWR/COMM +	Power supply, current output / HART output
PWR/COMM -	
EXT. METER	Current output 4 to 20 mA for external display
DIGITAL OUTPUT 1+	Digital output, positive pole
DIGITAL OUTPUT 2	Bridge after terminal 1+, NAMUR output OFF
DIGITAL OUTPUT 3	Bridge after terminal 4-, NAMUR output ON
DIGITAL OUTPUT 4-	Digital output, negative pole
ANALOG INPUT +	Analogue input 4 to 20 mA from external remote transmitter e.g., temperature or pressure
ANALOG INPUT -	



## Connection to remote mount design

Signal cable is available in four standard lengths: 5 m (16.4 ft), 10 m (32.8 ft), 20 m (65.6 ft) and 30 m (98.4 ft). The cable ends are already prepared for installation.

Signal cable may be cut to any desired length. Ensure cables are prepared correctly as per the following detail:-

### Sensor

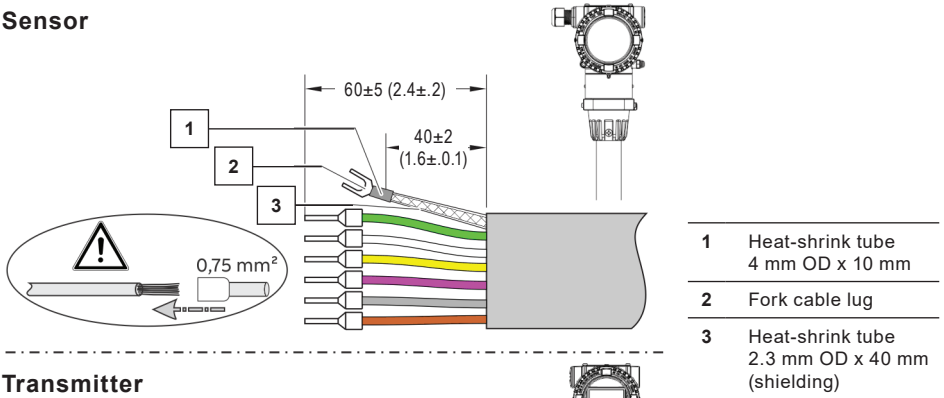

### Transmitter

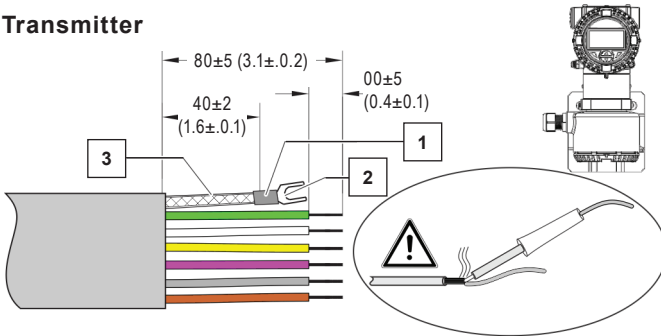

Fig. 12

Twist the shield, shorten and insulate with heat-shrink tube (3).  
Crimp a matching forked cable lug (2) and insulate the crimping with a heat-shrink tube (1).

- Attach wire-end ferrules ( $0.75 \text{ mm}^2$ ) to the wires on the sensor side.
- Twist the wires on the transmitter side and solder.



Before opening the transmitter housing or the terminal box, note the following points:

- Ensure sure that there is no explosion hazard.
- Switch off the power supply and wait at least 2 minutes before opening.

The signal cable is colour matched. Connect the cable as per the following directive:-

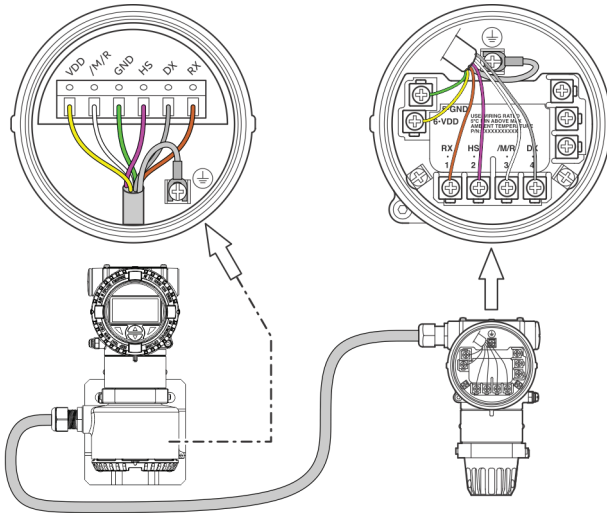



Fig. 13

Terminal	Colour / Function
VDD	Yellow
/M/R	White
GND	Green
HS	Pink
DX	Grey
RX	Brown
	Ground terminal (functional ground / shield)

# 5. Commissioning



## Risk of burns due to hot measuring media

The device surface temperature may exceed 70 °C (158 °F), depending on the measuring medium temperature!

- Before starting work on the device, make sure that it has cooled sufficiently.

**Note:** This QuickStart document provides basic commissioning guidance for the standard 4-20mA VLM30 unit.

For additional commissioning guidelines (HART & Modbus), please reference IM-P736-02.

## 5.1 Checks prior to commissioning

- Ensure the power supply to the flowmeter is switched off.
- The power supply used must match the information on the name plate.
- Correct wiring in accordance with Electrical connections on page XX.
- Correct grounding in accordance with Grounding on page XX.
- The ambient conditions must meet the requirements set out in the specification.
- The transmitter must be installed at a location largely free of vibrations.
- The housing cover and cover lock must be sealed before powering-up the power supply.
- For devices remote design devices, ensure that the sensor and transmitter are assigned correctly.

The device can be factory parameterized to customer specifications. If no customer information is available, the device will be delivered with factory settings:

Parameter	Factory Setting
Operating mode	Liquid Volume
Output value	Flow Rate
DO function	No function
$Q_{max}$	Set to $Q_{max}$ DN
Unit Q	m <sup>3</sup> /h

Parameter	Factory Setting
HART In value	No function
Low flow cut off	4%
I out @ alarm	Low
Low alarm value	3.55mA
High alarm value	22mA

**Note: For steam, please select ‘Steam/Water Mass’ as the operating mode.**

Please ensure the flow meter is correctly sized for the application.

## 5.2 Commissioning/Parameterization using the Easy Setup menu

Remove the transmitter / front housing to access the configuration buttons. You can now set the VLM30 parameters.

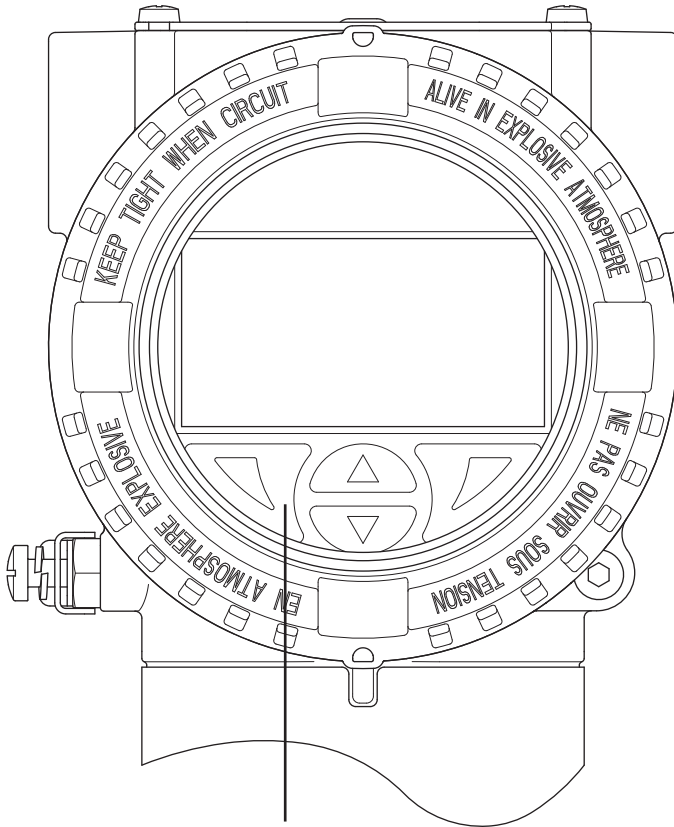

The Flowmeter display is equipped with four buttons. Use these buttons to access the Easy Setup menu.

Fig. 19

**1. Power up the unit so the initial display is visible:**

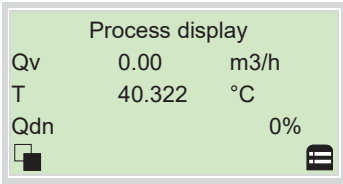

Switch to the configuration level using  (right-hand side button)

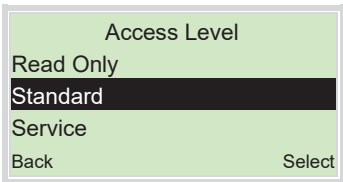

Use  /  and select 'Standard'.

Confirm the selection with 

If a password has been created, enter it. Otherwise select OK to proceed

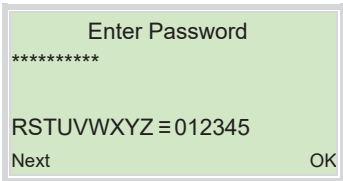

A password is not available as a factory default.

## 2. You will now enter the Easy Setup menu:

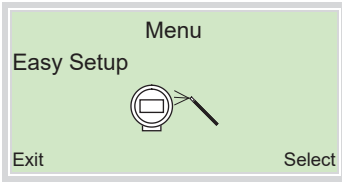

Use  /  make a selection.

Confirm your selection using 

### Selection of the menu language:

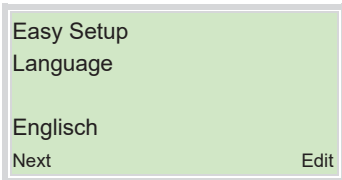



Use  to call up the edit mode.

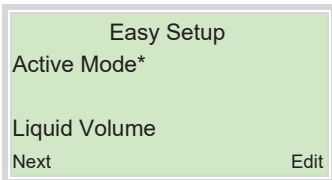

Use  /  to select the desired language.

Confirm the selection with  and continue with 'Next'.

### Select the operating mode





Use  to call up the edit mode.

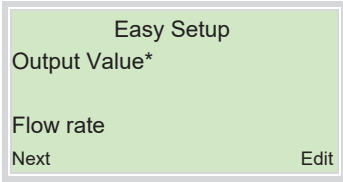

Use  /  to select the desired operating mode.

Confirm the selection with  and continue with 'Next'.

### 3. Configuration of the current output





Use  to call up the edit mode.

Use  /  to select the desired process value for the current output.

Confirm selection with  and select 'Next'

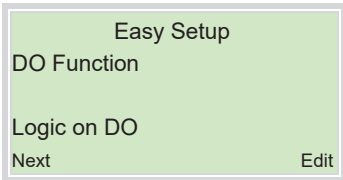
### 4. Configuration of the digital output



Use  to call up the edit mode.

Use  /  to select the desired mode for the digital output.



- Logic: DO operates as a switch
- Pulse: DO pulse per unit
- Freq: A frequency proportional to flow is emitted

Confirm selection with  and select 'Next'

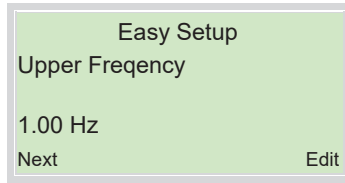
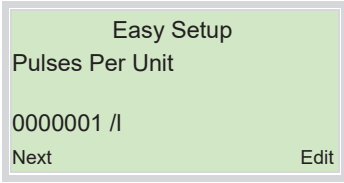
## 5. Depending on the DO selection set pulse or frequency values - A



Use  to call up the edit mode.



Use  /  /  to set pulses per unit (Pulse on DO) or upper frequency (Freq on DO)

Confirm selection with  and select 'Next'

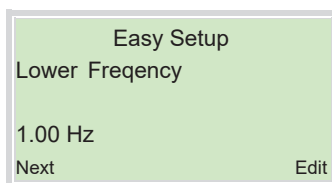
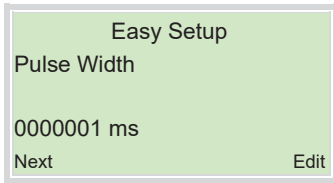
## 6. Set pulse or frequency – B



Use  to call up the edit mode.

Use  /  /  to set pulses per unit (Pulse on DO) or upper frequency (Freq on DO)



Confirm selection with  and select 'Next'

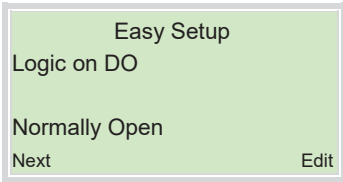

## 7. If 'Logic' is selected for the DO function



Use  to call up the edit mode.

Use  /  to select the switching behaviour for the binary output (NO or NC)

Confirm selection with  and select 'Next'

## 8. Selecting units

Units for the following parameters may be selected (depending on VLM30 type & configuration); Volume, mass, standard volume, power, density, temperature, pressure, volume flowmeter, mass flowmeter, standard volume flowmeter & energy.

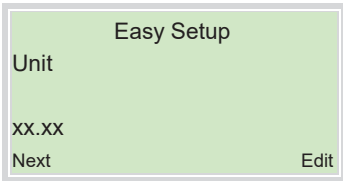

Use  to call up the edit mode.

Use  /  to select the desired units.

Confirm selection with  and select 'Next'

**9. If the device is analog/HART input enabled, the following options are available:**

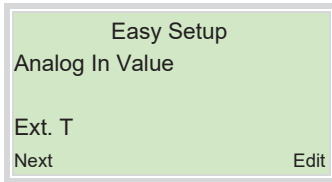

Use  to call up the edit mode.

Use  /  to select the desired analog / HART input function.

Confirm selection with  and select 'Next'

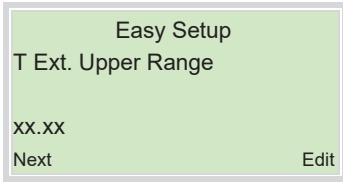

<b>Analog / HART Value</b>	<b>Function</b>	
Ext. T*	External temp Tx	
Pressure	External press Tx	*Ext. T = Temp Tx downstream of meter
Gas content	External gas analyser	
Density	External density Tx	*Int. T = Temp Tx upstream of meter
Int. T*	External temp Tx	
Ext. Cutoff	External output zero	

## 10. Set the measurement range for external Tx



Upper value = 20mA  
Lower value = 4mA

Use  to call up the edit mode.

Use  /  /  to select the desired external Tx measuring range.

Confirm selection with  and select 'Next'

### Parameters dependent on the operating mode

The next parameters are entirely dependent on the specific operating mode selected for the device. Refer to the operating instruction for detailed information.

For steam, please select 'Steam/Water Mass' as the operating mode. The default density selection is calculated using the internal temperature sensor (steam table). Edit this parameter if external transmitters are to be used for this function.

## 11. Setting of the flow rate or energy value at which the device must output 20mA (100%)

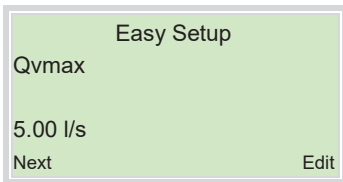

Use  to call up the edit mode.



Use  /  /  to select the desired external Tx measuring range.

Confirm selection with  and select 'Next'

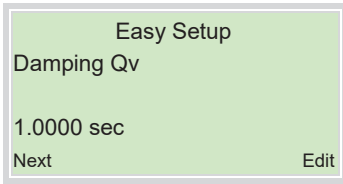
## 12. Adjusting the damping value



Use  to call up the edit mode.

Use  /  to select the desired damping value.

Confirm selection with  and select 'Next'

## 13. Configuration of the alarm signalling via the current output

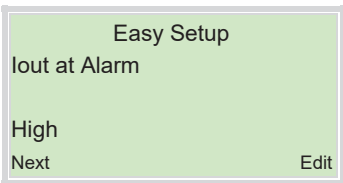

Use  to call up the edit mode.

Use  /  to select desired state

Confirm selection with  and select 'Next'

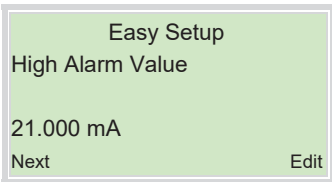

Use  to call up the edit mode.

Use  /  to set the desired alarm current.

Confirm selection with  and select 'Next'

For steam, please select 'Steam/Water Mass' as the operating mode. The default density selection is calculated using the internal temperature sensor (steam table). Edit this parameter if external transmitters are to be used for this function.

## 14. Zero point adjustment of the flowmeter

- Note:** Before starting the Auto Zero ensure:
- There is NO flow through the sensor
  - The sensor is filled with the medium to be measured

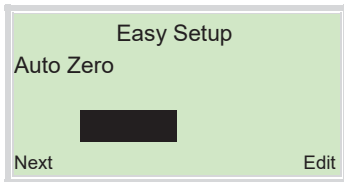

Use  to start automatic adjustment of the zero point for the system.

## 15. Configuration of the low flow cut-off

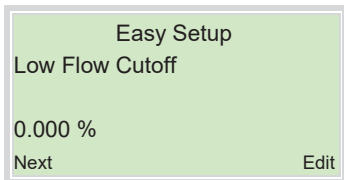

Use  to call up the edit mode.

Use  /  /  to set the desired value for the low flow cut-off.

Confirm selection with  and select 'Next'

## Easy setup complete

Once all the parameters have been configured, the main menu appears again. The most important parameters are set.

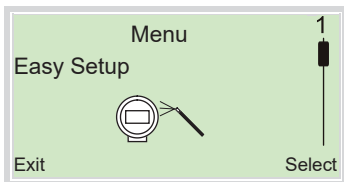

Use  to switch to the process display.

**The VLM30 device is  
now ready to use.**

For more further details, please  
reference the full installation manual:  
IM-P736-02

