

VLM30
In-Line Vortex Flowmeter
Installation and Maintenance Instructions

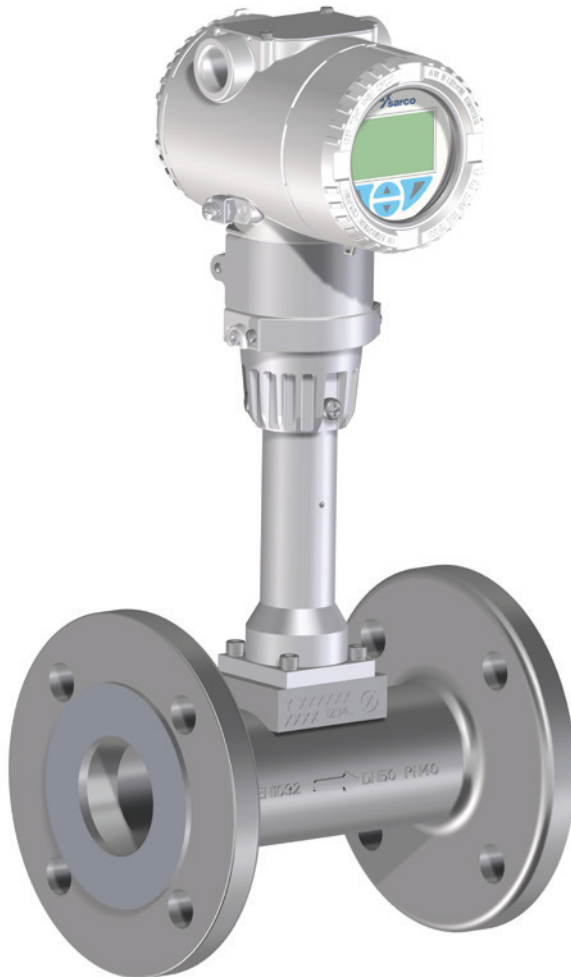

We use Warning, Caution and Note statements throughout this IM to draw your attention to important information.



Danger!

This statement appears with information that is important to protect people and equipment from damage. Failure to observe this information could result in death or severe injury.



Warning!

This statement appears with information that is important to protect people and equipment from damage. Pay very close attention to all warnings that apply to your application.



Caution!

This statement appears with information that is important for protecting your equipment and performance. Read and follow all cautions that apply to your application.



Note

This statement appears with a short message to alert you to an important detail.

Customer Notice for Oxygen Service

This flowmeter is not intended for oxygen service.

Spirax Sarco Limited is not liable for any damage or personal injury, whatsoever, resulting from the use of Spirax Sarco Vortex Insertion and In-line flowmeters for oxygen gas.

Customer Notice for EMC Class Division

This flowmeter is suitable for EMC Class A environments only.

Class A equipment is suitable for use in all establishments other than domestic and those connected to a low voltage power supply network which supplies buildings used for domestic purposes.

There may be potential difficulties in ensuring electromagnetic compatibility in other environments, due to conducted as well as radiated disturbances.

Contents

Warning, Caution and Note statements	3
1. Safety information	7
1.1 Intended use	
1.2 Access	8
1.3 Lighting	
1.4 Hazardous liquids or gases in the pipeline	
1.5 Hazardous environment around the product	
1.6 The system	
1.7 Pressure systems	
1.8 Temperature	9
1.9 Tools and consumables	
1.10 Protective clothing	
1.11 Permits to work	
1.12 Handling	
1.13 Residual hazards	
1.14 Freezing	
1.15 Returning products	10
1.16 Replacement parts	
1.17 Disposal	
1.18 Transport and Storage	11
2. General product information	13
2.1 How the Vortex Flowmeter Operates	16
2.2 Nameplate	18

3. Installation	19
3.1 Installation Conditions	20
3.2 Inlet and Outlet Recommendations	21
3.3 Installation at high measuring medium temperatures	22
3.4 Installation for external pressure and temperature measurement	23
3.5 Installation of setting equipment	
3.6 Sensor Insulation	24
3.7 Ambient Conditions	25
3.8 Material Load	26
3.9 Installing the sensor	30
3.10 Centering the wafer type design	31
3.11 Adjusting the transmitter position	32
3.12 Rotating the LCD indicator	33
3.13 Opening and closing the housing	34
3.14 Signal Cables	
3.15 Installing the connection cables	35
3.16 Cable glands	
3.17 Grounding	36
3.18 Devices with HART® communication	37
3.19 Devices with Modbus® communication	44
3.20 Cable specification	
3.21 Connection to remote mount design	47
4. Commissioning	
4.1 Safety instructions	51
4.2 General	
4.3 Digital output	52
4.4 Checks prior to commissioning	53
4.5 Power Supply Power-Up	
4.6 Checks after switching on the power supply	54
4.7 Checking and configuring the basic settings	
4.8 Parameterisation via the menu function Easy Setup	55
4.9 Devices with HART® and Modbus® communication	62

5. Operation	
5.1 Safety instructions	82
5.2 Account and password	
5.3 Parameterisation of the device	
5.4 Menu navigation	83
5.5 Menu levels	84
5.6 Process display	85
5.7 Switching to the configuration level (parameterisation)	87
5.8 Selecting and changing parameters	88
5.9 Error messages on the LCD display	90
5.10 Parameter overview	91
5.11 Parameter descriptions	100
5.12 Zero point balance under operating conditions	122
5.13 Advanced filter	123
6. Maintenance	124
6.1 Safety instructions	
6.2 Cleaning	125
6.3 Sensor	
7. Diagnosis/Error Messages	
7.1 General Notes	
7.2 Sensor	126
7.3 Application conditions	
7.4 Zero point balancing	
7.5 Pipe vibrations	
7.6 Transmitter	127
7.7 Calling up the error description	
7.8 Possible error messages	128
8. Repair	139
8.1 Replacing the transmitter, downloading system data	
8.2 Removal from the line	140
9. Spares	141
10. Appendix	146
10.1 Measuring range tables	

1. Safety Information

Supplier:

Spirax-Sarco Limited
Charlton House
Charlton Kings
Cheltenham
Glos
GL53 8ER

	<p>Warning! Consult the flowmeter nameplate for specific flowmeter approvals before any hazardous location installation.</p> <p>All flowmeter connections, isolation valves and fittings for cold/hot tapping must have the same or higher pressure rating as the main pipeline.</p> <p>To avoid serious injury, DO NOT loosen a compression fitting under pressure.</p> <p>To avoid potential electric shock, follow National Electric Code or your local code when wiring this unit to a power source. Failure to do so could result in injury or death. All ac power connections must be in accordance with published CE directives. All wiring procedures must be performed with the power Off.</p> <p>Before attempting any flowmeter repair, verify that the line is not pressurised. Always remove main power before disassembling any part of the mass flowmeter.</p>
---	---

	<p>Caution! Calibration must be performed by qualified personnel. Spirax Sarco strongly recommends that you return your flowmeter to the factory for calibration.</p> <p>In order to achieve accurate and repeatable performance, the flowmeter must be installed with the specified minimum length of straight pipe upstream and downstream of the flowmeter's sensor head.</p> <p>When using toxic or corrosive gases, purge the line with inert gas for a minimum of four hours at full gas flow before installing the flowmeter.</p> <p>The ac wire insulation temperature rating must meet or exceed 85 °C (185 °F).</p>
--	--

1.1 Intended use

Referring to the Installation and Maintenance Instructions, name-plate and Technical Information Sheet, check that the product is suitable for the intended use/application. The product listed complies with the requirements of the EU Pressure Equipment Directive/UK Pressure Equipment (Safety) Regulations and carries the   marks.

- i) The products have been specifically designed for use on steam.
- ii) Check material suitability, pressure and temperature limits, are correct prior to installation. If the maximum operating limits of the product are lower than those of the system in which it is being fitted, or if malfunction of the product could result in a dangerous overpressure or overtemperature occurrence, ensure a safety device is included in the system to prevent such over-limit situations.
- iii) Determine the correct installation situation and direction of fluid flow.
- iv) Spirax Sarco products are not intended to withstand external stresses that may be induced by any system to which they are fitted. It is the responsibility of the installer to consider these stresses and take adequate precautions to minimise them.
- v) Remove protection covers from all connections and protective film from all name-plates, where appropriate, before installation on steam or other high temperature applications.

These instructions must be stored in a safe place near the product installation at all times.

Warning

This product complies with Electromagnetic Compatibility Directive 2014/30/EU and all its requirements.

The product may be exposed to interference above the limits of Heavy Industrial Immunity if:

- The product or its wiring is located near a radio transmitter.
- Excessive electrical noise occurs on the supply. Line protectors can be used with combine filtering, suppression, surge and spike arrestors.
- Cellular telephones and mobile radios may cause interference if used within approximately 1 metre (39") of the product or its wiring. The actual separation distance necessary will vary according to the surroundings of the installation and the power of the transmitter.

Electrostatic Discharge (ESD) precautions.

Static precautions must be observed at all times to avoid damage to the product.

1.2 Access

Ensure safe access and if necessary a safe working platform (suitably guarded) before attempting to work on the product. Arrange suitable lifting gear if required.

1.3 Lighting

Ensure adequate lighting, particularly where detailed or intricate work is required.

1.4 Hazardous liquids or gases in the pipeline

Consider what is in the pipeline or what may have been in the pipeline at some previous time. Consider: flammable materials, substances hazardous to health, extremes of temperature.

1.5 Hazardous environment around the product

Consider: explosion risk areas, lack of oxygen (e.g. tanks, pits), dangerous gases, extremes of temperature, hot surfaces, fire hazard (e.g. during welding), excessive noise, moving machinery.

1.6 The system

Consider the effect on the complete system of the work proposed. Will any proposed action (e.g. closing isolation valves, electrical isolation) put any other part of the system or any personnel at risk? Dangers might include isolation of vents or protective devices or the rendering ineffective of controls or alarms. Ensure isolation valves are turned on and off in a gradual way to avoid system shocks.

1.7 Pressure systems

Ensure that any pressure is isolated and safely vented to atmospheric pressure. Consider double isolation (double block and bleed) and the locking or labelling of closed valves. Do not assume that the system has depressurised even when the pressure gauge indicates zero.

1.8 Temperature

Allow time for temperature to normalise after isolation to avoid danger of burns.

1.9 Tools and consumables

Before starting work ensure that you have suitable tools and/or consumables available. Use only genuine Spirax Sarco replacement parts.

1.10 Protective clothing

Consider whether you and/or others in the vicinity require any protective clothing to protect against the hazards of, for example, chemicals, high/low temperature, radiation, noise, falling objects, and dangers to eyes and face.

1.11 Permits to work

All work must be carried out or be supervised by a suitably competent person. Installation and operating personnel should be trained in the correct use of the product according to the Installation and Maintenance Instructions. Where a formal 'permit to work' system is in force it must be complied with. Where there is no such system, it is recommended that a responsible person should know what work is going on and, where necessary, arrange to have an assistant whose primary responsibility is safety.

Post 'warning notices' if necessary.

1.12 Handling

Manual handling of large and/or heavy products may present a risk of injury. Lifting, pushing, pulling, carrying or supporting a load by bodily force can cause injury particularly to the back. You are advised to assess the risks taking into account the task, the individual, the load and the working environment and use the appropriate handling method depending on the circumstances of the work being done.

1.13 Residual hazards

In normal use the external surface of the product may be very hot. If used at the maximum permitted operating conditions the surface temperature of some products may reach temperatures of 239 °C (462 °F). Many products are not self-draining. Take due care when dismantling or removing the product from an installation (refer to 'Maintenance instructions').

1.14 Freezing

Provision must be made to protect products which are not self-draining against frost damage in environments where they may be exposed to temperatures below freezing point.

1.15 Returning products

Customers and stockists are reminded that under EC Health, Safety and Environment Law, when returning products to Spirax Sarco they must provide information on any hazards and the precautions to be taken due to contamination residues or mechanical damage which may present a health, safety or environmental risk. This information must be provided in writing including Health and Safety data sheets relating to any substances identified as hazardous or potentially hazardous.

Please provide the following information with any equipment being returned:

1. Your name, Company name, address and telephone number, order number and invoice and return delivery address.
2. Description of equipment being returned.
3. Description of the fault.
4. If the equipment is being returned under warranty, please indicate:
 - i. Date of purchase
 - ii. Original order number
 - iii. Serial number

Please return all items to your local Spirax Sarco branch.

Please ensure all items are suitably packed for transit (preferably in the original cartons).

1.16 Replacement parts

Only use Spirax Sarco recommended parts as functionality/operation of the unit may otherwise be impaired.

1.17 Disposal

On disposal of the unit or component, appropriate precautions should be taken in accordance with Local/National regulations. Unless otherwise stated in the Installation and Maintenance Instructions this product is recyclable and no ecological hazard is anticipated with its disposal providing due care is taken.

Please visit the Spirax Sarco product compliance web pages:

<https://www.spiraxsarco.com/product-compliance>

for up to date information on any substances of concern that may be contained within this product. Where no additional information is provided on the Spirax Sarco product compliance web page, this product may be safely recycled and/or disposed providing due care is taken. Always check your local recycling and disposal regulations.

1.18 Transport and Storage

Inspection

Check the devices immediately after unpacking for possible damage that may have occurred from improper transport. Details of any damage that has occurred in transit must be recorded on the transport documents. All claims for damages must be submitted to the shipper without delay and before installation.

Transport

	<p>Danger! Life-threatening danger due to suspended loads. In the case of suspended loads, a danger of the load falling exists.</p> <ul style="list-style-type: none">- Standing under suspended loads is prohibited.
---	---

	<p>Warning! Risk of injury due to device slipping.</p> <ul style="list-style-type: none">- The device's center of gravity may be higher than the harness suspension points.- Make sure that the device does not slip or turn during transport.- Support the device laterally during transport.
---	--

1.19 Food Contact

This product is not to be used on steam, liquid or gas that either forms an ingredient of, or comes into direct contact with food products in the EU.

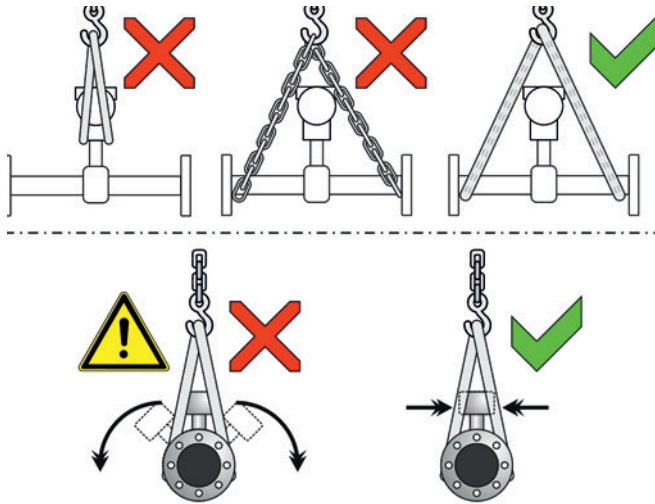

Flanged devices \leq DN300

- Use carrying straps to transport flange designs smaller than DN350.
- Wrap the carrying straps around both process connections when lifting the device. Chains should not be used, since these may damage the housing.

Flange devices $>$ DN300

- Using a forklift to transport flange device can dent the housing.
- Flange devices must not be lifted by the center of the housing when using a forklift for transport.
- Flange devices must not be lifted by the terminal box or by the center of the housing.
- Only the transport lugs fitted to the device can be used to lift the device and insert it into the piping.

Storing the device

Bear the following points in mind when storing devices:

- Store the device in its original packaging in a dry and dust-free location.
- Observe the permitted ambient conditions for transport and storage.
- Avoid storing the device in direct sunlight.
- In principle, the devices may be stored for an unlimited period. However, the warranty conditions stipulated in the order confirmation of the supplier apply.

Ambient conditions

The ambient conditions for the transport and storage of the device correspond to the ambient conditions for operation of the device.

Refer to Ambient conditions in Section 3.7.

Returning devices

For the return of devices, follow the instructions in Section 8.1 Replacing the transmitter, Section 8.2 Removal from the line, and Section 1.15 Returning products.

2. General Product Information



Integral mount design in flange design



Integral mount design in wafer type design

Fig. 1 VLM30 Variants

VLM30 for steam, liquid and gas, with optional graphical display, optional binary output, and optional integrated temperature measurement.

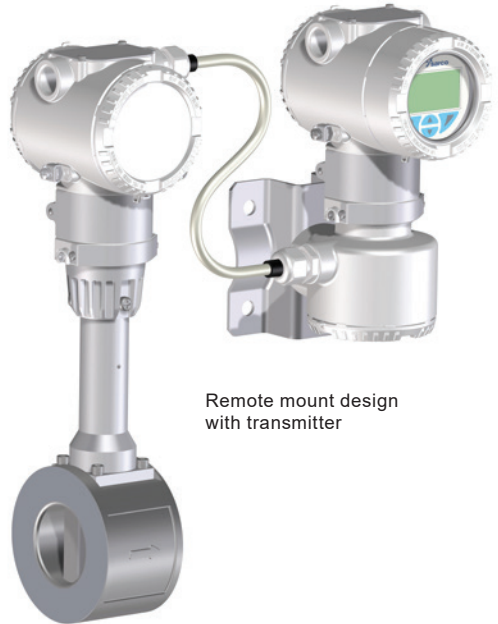

Remote mount design with transmitter

VLM30 In-Line Vortex Flowmeter

Caution: When selecting a vortex flow meter for steam flow measuring, care must be taken around the low flow velocity as this can cause instability in the flow measurement readings. Please ensure the appropriate flow meter size is selected via the sizing tool for the application.

Sensor

Model Number	VLM30-S	VLM30-E
Design	Integral mount design, remote mount design.	
IP Degree of protection in accordance	IP66, IP67 and NEMA 4X	
Measuring accuracy for liquids*	≤ ±0.65% under reference conditions.	
Measuring accuracy for gasses or vapours*	≤ ±0.9% under reference conditions.	
Repeatability	DN25 (1") to DN150 (6"): ≤ ±0.2%, from DN200 (8"): ≤ ±0.25%	
Permissible viscosity for liquids	DN25 (1"): ≤ 5 mPa s, from DN40 (1½"): ≤ 7.5 mPa s	
Measuring span (typical)	1:20	
Process connections	Flange: DN25 to 300 (1" to 12") Wafer type: DN25 to 150 (1" to 6")	

Inlet/outlet Sections (typical)

Temperature measurement	Resistance thermometer Pt100 class A optional, installed in Piezo sensor, can be retrofitted.	Resistance thermometer Pt100 class A standard, fixed installation in Piezo sensor.
Permissible measuring medium temperature	Standard: -55 to 280 °C (-67 to 536 °F), Optional: -55 to 350 °C (-67 to 662 °F).	

* Indication of accuracy in% of the measured value (% of meas.val.).

Measuring accuracy - Reference conditions

Flow measurement

Set flow range	0.5 to 1 x Q _{vmax} DN
Ambient temperature	20 °C (68 °F) ±2 K
Relative humidity	65%, ±5%
Air Pressure	86 to 106 kPa
Power supply	24 Vdc
Signal cable length (for remote mount design)	30 m (98 ft)
Current output load	250 Ω (only 4 to 20 mA)
Measuring medium for calibration	Water, approx. 20 °C (68 °F), 2 bar (29 psi) Air, 960 mbar abs. ±50 mbar (14 psi a ±0.7 psi), 24 °C ±4 °C (75 °F ±7 °F)
Calibration loop internal diameter	corresponds to inside diameter of device
Unobstructed straight inlet section	15 × DN
Outlet section	5 × DN
Pressure measurement	3 × DN to 5 × DN behind the flowmeter

VLM30 In-Line Vortex Flowmeter

Wetted material

Sensor	Stainless steel.
Gasket	PTFE, optional Graphite.
Sensor housing	Stainless Steel.
Sensor design	Piezo sensor with two pairs of sensors for flow measurement and vibration compensation.

Transmitter (VLM30-S/VLM30-E)

Display	Optional LCD indicator with four operating buttons for operation through front glass (option).
---------	--

Operating Modes

Liquids	Operating volume, standard volume, mass.
Gases	Operating volume, standard volume, mass.
Steam	Operating volume, mass.
Digital Output	Optional, can be configured as pulse output, frequency output or alarm output via software.
Inputs for external sensors	HART® input for external pressure or temperature transmitter communicating in HART burst mode.
Current output, communication	4 to 20 mA, HART® (HART 7), Modbus RTU®
Power supply	12 to 42 Vdc

2.1 How the Vortex Flowmeter Operates

The operating principle of the Vortex flowmeter is based on the Karman street. As the measuring medium flows over and under the bluff body, vortices are shed alternately above and below. The shedding of these vortices due to the flow forms a vortex trail (Karman vortex street).

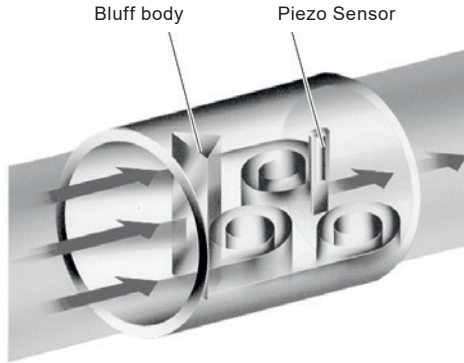

Fig. 2 Measuring principle

Here, the frequency f of vortex shedding is proportional to the medium velocity v and inversely proportional to the width of the bluff body d .

$$f = St \times \frac{v}{d}$$

St , known as the Strouhal number, is a dimensionless number, which has a decisive impact on the quality of vortex flow measurement. If the bluff body is dimensioned appropriately, the Strouhal number (St) remains constant across a very wide range of the Reynolds number (Re).

$$Re = \frac{v \times D}{\vartheta}$$

ϑ Kinematic viscosity

D Nominal diameter of meter tube

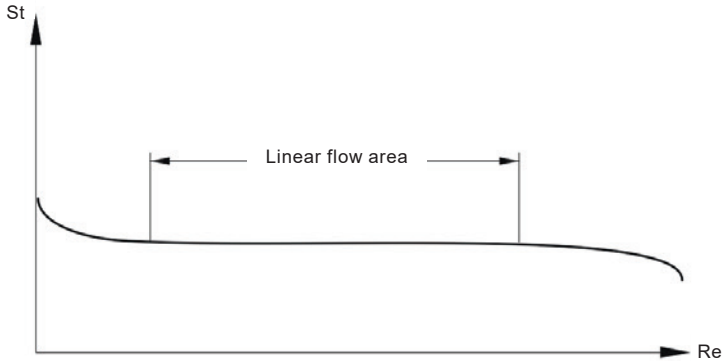

Fig. 3 How the Strouhal number is dependent upon the Reynolds number

Consequently, the vortex shedding frequency to be evaluated is dependent solely upon the flow velocity and not at all upon measuring medium density and viscosity. The local pressure variations induced by vortex shedding are detected by a piezo sensor and converted into electrical pulses corresponding to the vortex frequency. The frequency signal from the flowmeter sensor, which is proportional to the flow, undergoes downstream processing in the transmitter.

2.2 Nameplate



Fig. 4(a) Name Plate

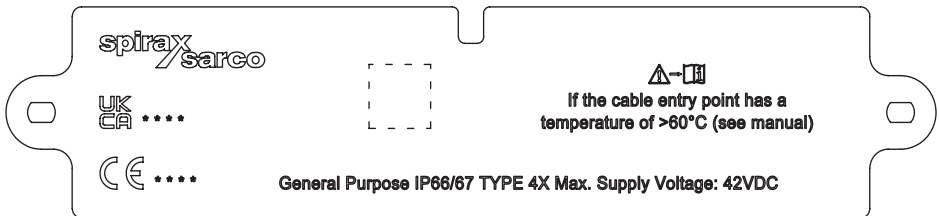

Fig. 4(b) Additional Plate with Approvals (example shown)

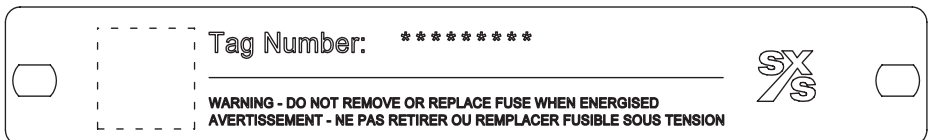

Fig. 4(c) Plate with measuring point tagging (Tag number)

3. Installation



Warning!

Risk of injury due to device slipping.

- The device's center of gravity may be higher than the harness suspension points.
- Make sure that the device does not slip or turn during transport.
- Support the device laterally during transport.



Warning!

Risk of injury due to live parts!

When the housing is open, contact protection is not provided and EMC protection is limited.

- Before opening the housing, switch off the power supply.



Caution!

Risk of burns due to hot measuring media

The device surface temperature may exceed 70 °C (158 °F), depending on the measuring medium temperature!

- Before starting work on the device, make sure that it has cooled sufficiently.



Damage to components!

The electronic components of the printed circuit board can be damaged by static electricity (observe ESD guidelines).

- Make sure that the static electricity in your body is discharged before touching electronic components.

3.1 Installation Conditions

General

A Vortex meter can be installed at any point in the pipeline system. However, the following installation conditions must be considered:

- Compliance with the ambient conditions.
- Compliance with the recommended inlet and outlet sections.
- The flow direction must correspond to that indicated by the arrow on the sensor.
- Compliance with the required minimum interval for removing the transmitter and replacing the sensor.
- Avoidance of mechanical vibrations of the piping (by fitting supports if necessary).
- The inside diameter of the sensor and the piping must be identical.
- Avoidance of pressure oscillations in long piping systems at zero flow by fitting gates at intervals.
- Attenuation of alternating (pulsating) flow during piston pump or compressor conveying by using appropriate damping devices. The residual pulse must not exceed 10%. The frequency of the conveying equipment must not be within the range of the measuring frequency of the flowmeter.
- Valves/gates should normally be arranged in the flow direction downstream of the flowmeter (typically: $3 \times DN$). If the medium is conveyed through piston/plunger pumps or compressors (pressures for fluids $> 10 \text{ bar}/145 \text{ psi}$), it may be subject to hydraulic vibration in the pipeline when the valve is closed. If this does occur, the valve absolutely has to be installed in the flow direction upstream of the flowmeter. Suitable damping devices (e.g. air vessels) might need to be fitted.

When fluids are measured, the sensor must always be filled with measuring medium and must not run dry.

- When fluids are measured and during damping, there must be no evidence of cavitation.
- The relationship between the measuring medium and the ambient temperature must be taken into consideration.
- At high measuring medium temperatures $> 150 \text{ }^\circ\text{C}$ ($> 302 \text{ }^\circ\text{F}$), the sensor must be installed so that the transmitter or terminal box is pointing to the side or downward.

3.2 Inlet and Outlet Recommendations

In order to maximise operational reliability, the flow profile at the inflow end must not be distorted if at all possible. The figures below show the recommended inlet and outlet Sections for various installations.

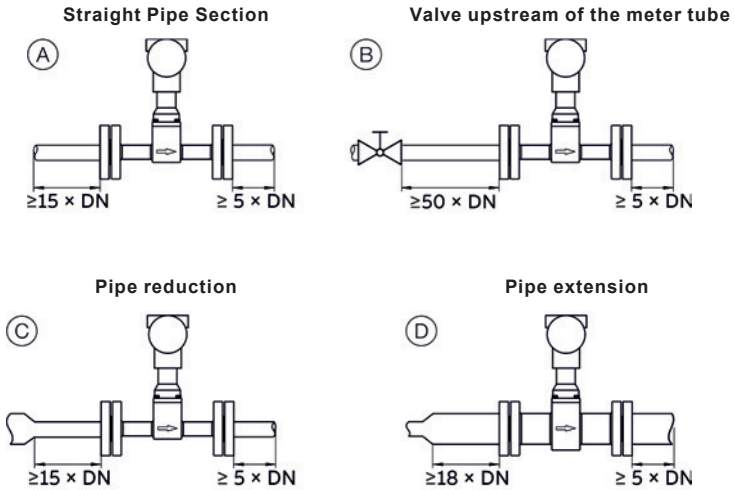

Fig. 5 Straight pipe Sections

Installation	Inlet Section	Outlet Section
Straight Pipe Section	minimum 15 x DN	minimum 5 x DN
Valve upstream of the meter tube	minimum 50 x DN	minimum 5 x DN
Pipe reduction	minimum 15 x DN	minimum 5 x DN
Pipe extension	minimum 18 x DN	minimum 5 x DN

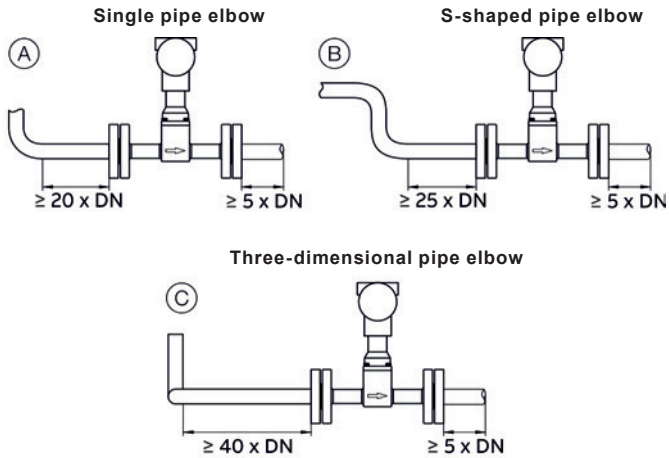

Fig. 6 Pipe Sections with pipe elbows

Installation	Inlet Section	Outlet Section
Single pipe elbow	minimum $20 \times DN$	minimum $5 \times DN$
S-shaped pipe elbow	minimum $25 \times DN$	minimum $5 \times DN$
Three-dimensional pipe elbow	minimum $40 \times DN$	minimum $5 \times DN$

3.3 Installation at high measuring medium temperatures

At high measuring medium temperatures $> 150 \text{ }^\circ\text{C}$ ($> 302 \text{ }^\circ\text{F}$), the sensor must be installed so that the transmitter is pointing to the side or downward.

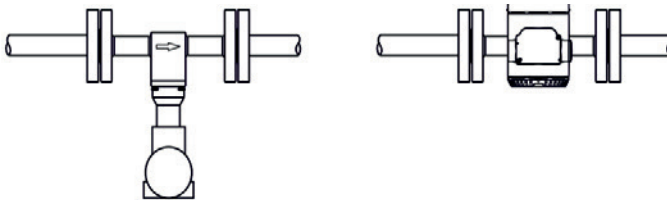

Fig. 7 Installation at high measuring medium temperatures

3.4 Installation for external pressure and temperature measurement

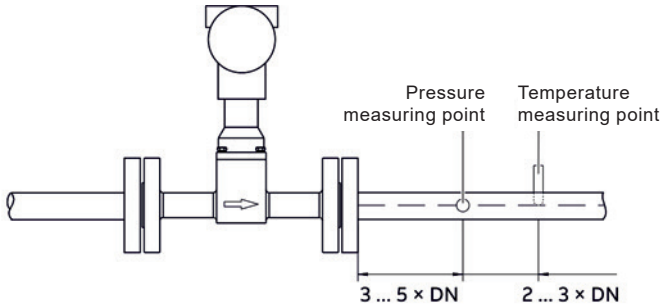

Fig. 8 Arrangement of the temperature and pressure measuring points

If pressure and temperature are to be compensated externally (e.g. using the flow computer unit), the measuring points must be installed as illustrated.

3.5 Installation of setting equipment

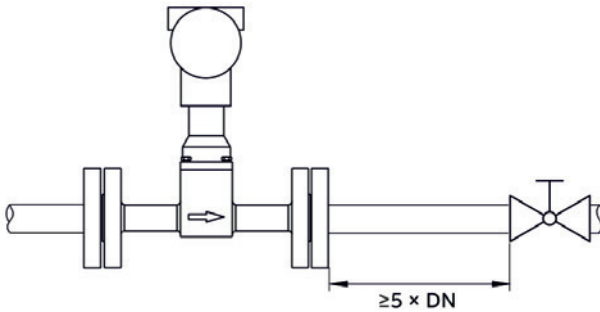

Fig. 9 Installation of setting devices

Control and setting devices should be arranged in the forward flow direction **downstream** from the flowmeter at a distance of at least $5 \times DN$.

If the measuring medium is conveyed through piston pumps/plunger pumps or compressors (pressures for fluids > 10 bar [> 145 psi]), it may be subject to hydraulic vibration in the piping when the valve is closed.

If this is the case, it is essential that the valve be installed in the forward flow direction **upstream** from the flowmeter. Suitable dampers (for example, air vessels in the case of pumping using a compressor) might need to be used.

3.6 Sensor Insulation

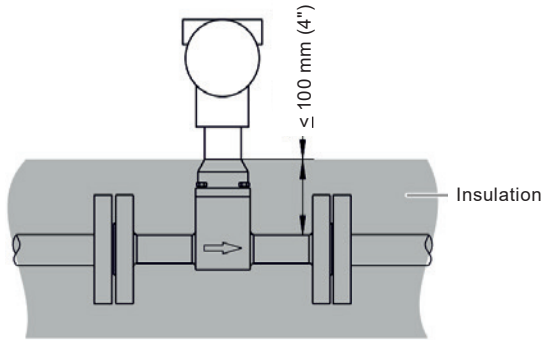

Fig. 10 Insulation of the meter tube

The piping can be insulated up to a thickness of 100 mm (4").

Use of trace heating

Trace heating may be used under the following conditions:

- If it is installed directly on or around the piping.
- If, in the case of existing pipeline insulation, it is installed inside the insulation (the maximum thickness of 100 mm [4"] must not be exceeded).
- If the maximum temperature the trace heating is able to produce is less than or equal to the maximum medium temperature.

Note: Installation requirements in accordance with EN 60079-14 must be observed. Please note that the use of trace heaters will not impair EMC protection or generate additional vibrations.

3.7 Ambient Conditions

In accordance with IEC 60068-2-78

Ambient temperature range (T_{amb})	Standard	-20 to 85 °C (-4 to 185 °F)
	Advanced Mode	-40 to 85 °C (-40 to 185 °F)
Relative humidity	Maximum 85%, annual average \leq 65%	
Measuring medium temperature range (T_{medium})	Standard	-55 to 280 °C (-67 to 536 °F)
	High-temperature version (option)	-55 to 350 °C (-67 to 662 °F)

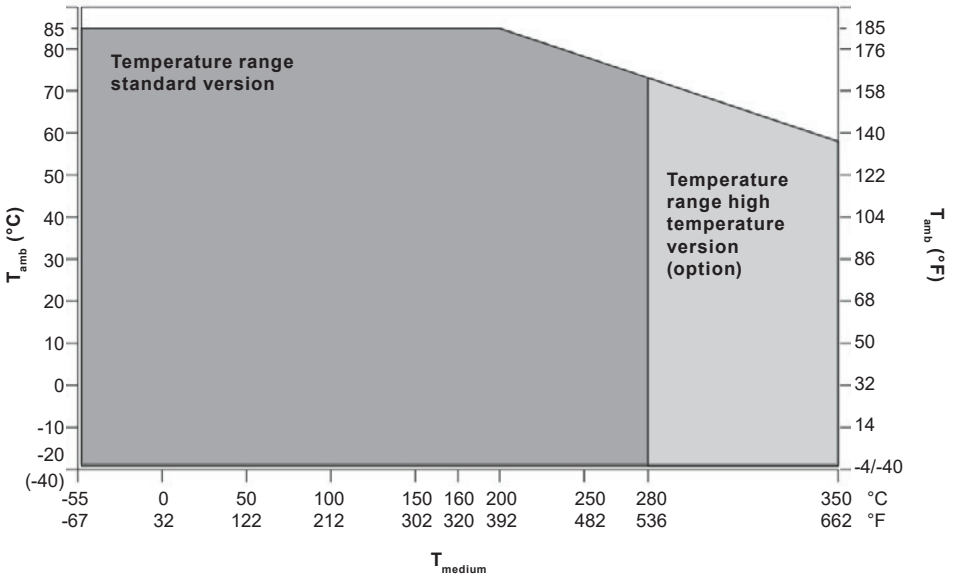

Fig. 11
Measuring medium temperature T_{medium} dependent on the ambient temperature T_{amb} .

3.8 Material Load

Flanged Devices

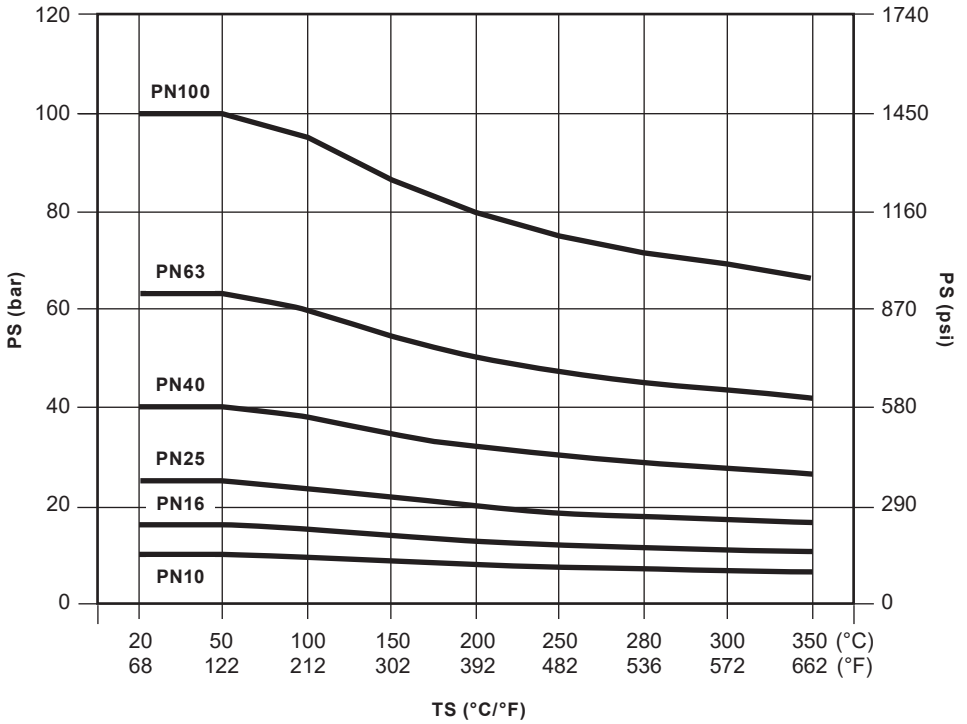

Fig. 12(a) DIN Flange process connection

3.8 Material Load (continued)

Flanged Devices

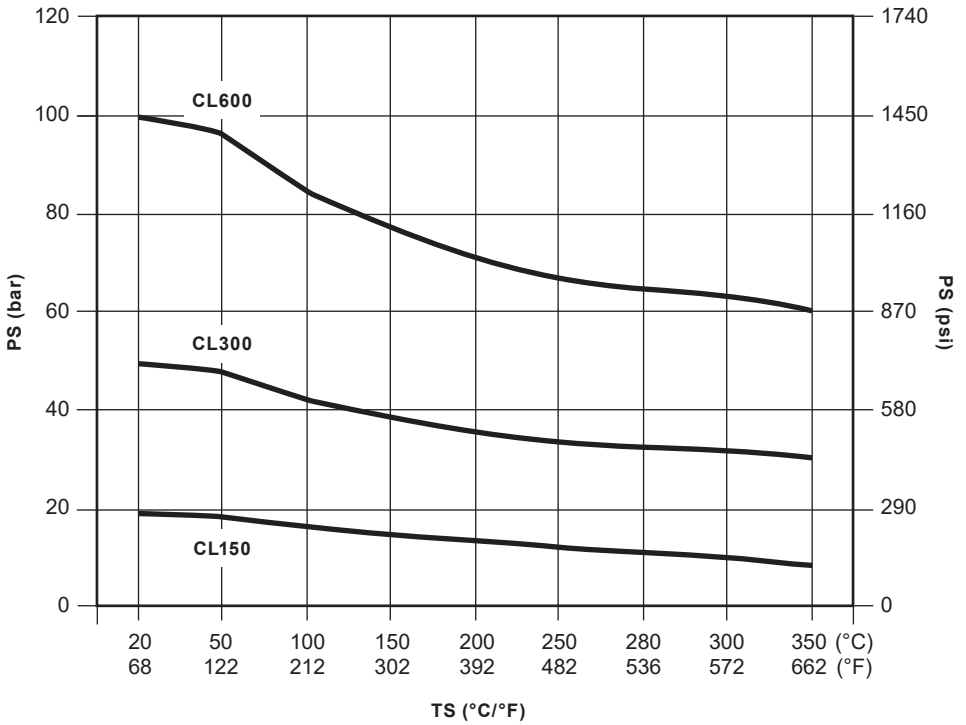

Fig. 12(b) ASME Flange process connection

3.8 Material Load (continued)

Wafer Type Devices

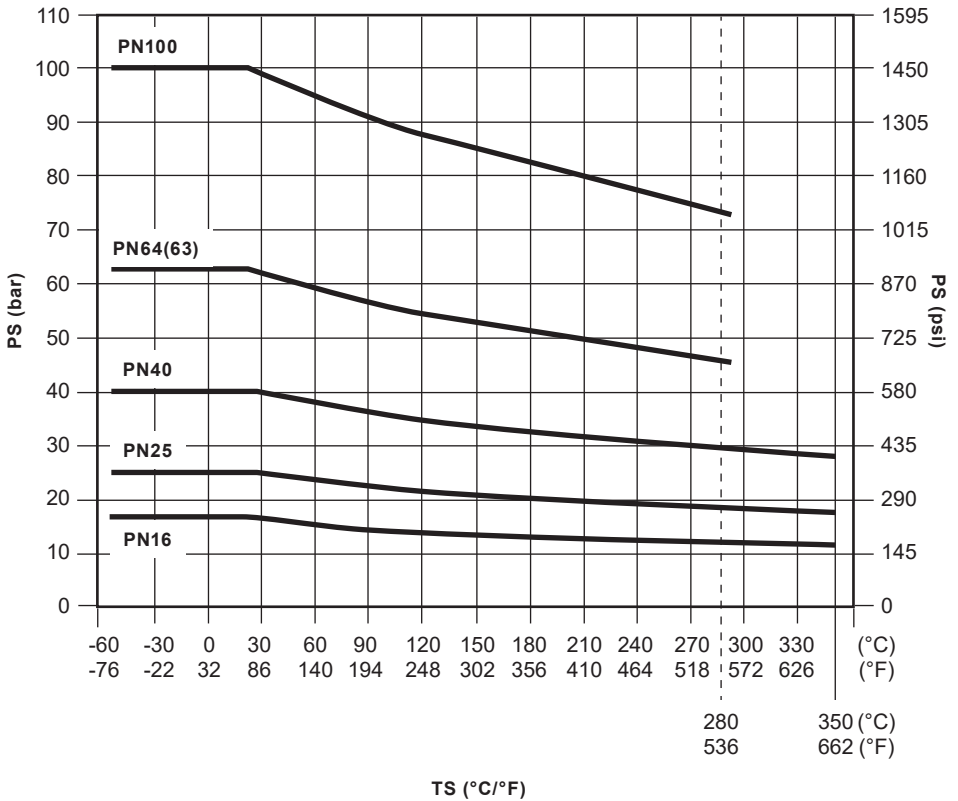

Fig. 13(a) DIN Wafer type process connection

3.8 Material Load (continued)

Wafer Type Devices

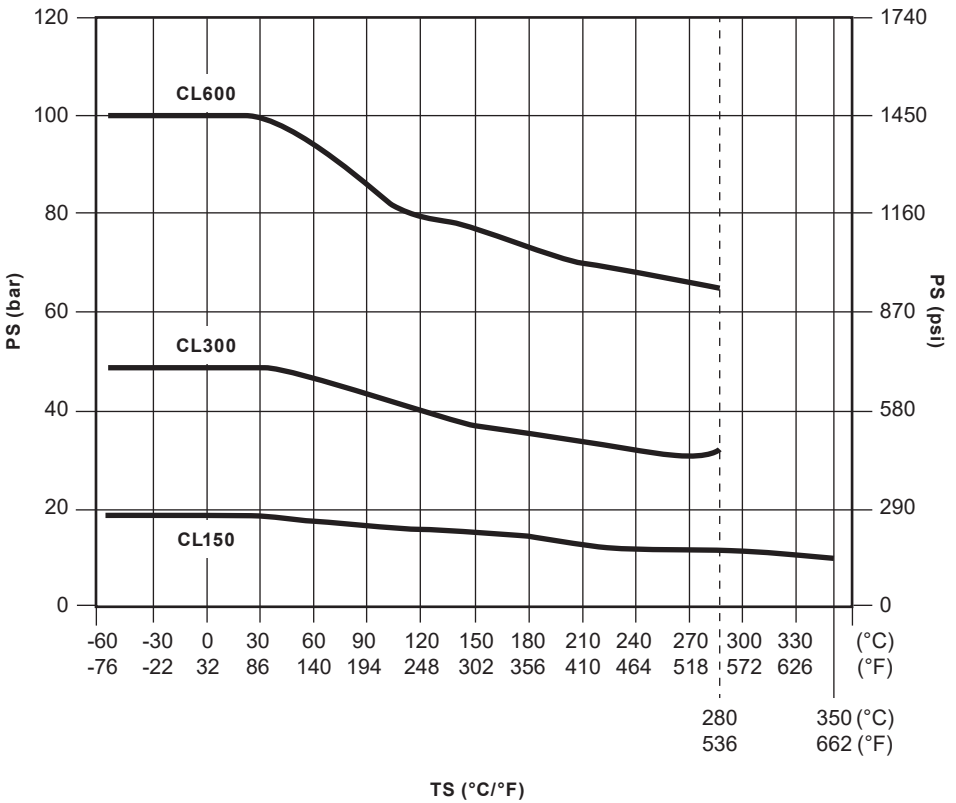

Fig. 13 (b) ASME Wafer type process connection

3.9 Installing the sensor

Observe the following points during installation:

- For devices with a remote mount design, make sure that the sensor and transmitter are assigned correctly.
- The flow direction must correspond to the marking, if present.
- The maximum torque must be observed for all flanged connections.
- The devices must be installed without mechanical tension (torsion, bending).
- Wafer type devices with plane parallel counter flanges should be installed with suitable gaskets only.
- Use gaskets made from a material that is compatible with the measuring medium and measuring medium temperature.
- The piping may not exert any inadmissible forces or torques on the device.
- Do not remove the sealing plugs in the cable glands until you are ready to install the electric lines.
- Make sure the gaskets for the housing cover are seated correctly. Carefully seal the cover. Tighten the cover fittings.
- Do not expose the transmitter to direct sunlight and provide for appropriate sun protection where necessary.
- When selecting the installation location, make sure that moisture cannot penetrate into the terminal box or the transmitter housing.

Installation of the flowmeter

The device can be installed at any location in a pipeline under consideration of the installation conditions.

1. Position the meter tube coplanar and centered between the piping.
2. Install gaskets between the sealing surfaces.

Note:

- To achieve the best results, make sure that the gaskets and meter tube fit concentrically.
- To guarantee that the flow profile is not distorted, the gaskets must not protrude into the piping.

3. Use the appropriate screws for the holes.
4. Slightly grease the threaded nuts.

5. Tighten the nuts in a crosswise manner as shown in the figure.

First tighten the nuts to approximately 50% of the maximum torque, then to approximately 80%, and finally a third time to the maximum torque.

Note: Torques for screws depend on temperature, pressure, screw and gasket materials. The relevant applicable regulations must be taken into consideration.

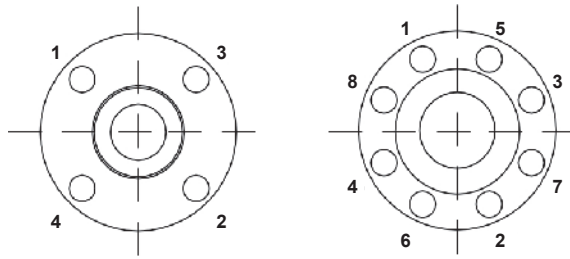

Fig. 14 Tightening sequence for the flange screws

3.10 Centering the wafer type design

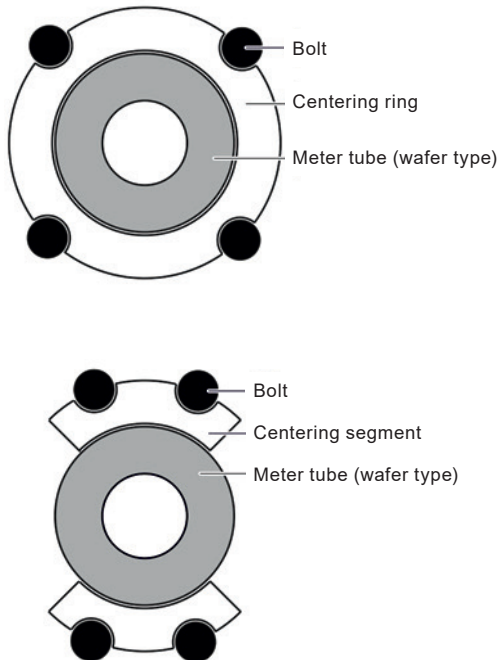

Fig. 15 Centering the wafer type design with the ring or segment

3.11 Adjusting the transmitter position



NOTE

Damage to components!

- The transmitter housing must not be lifted without pulling out the cable, otherwise the cable can tear off.
- The transmitter housing must not be rotated more than 360 degrees.

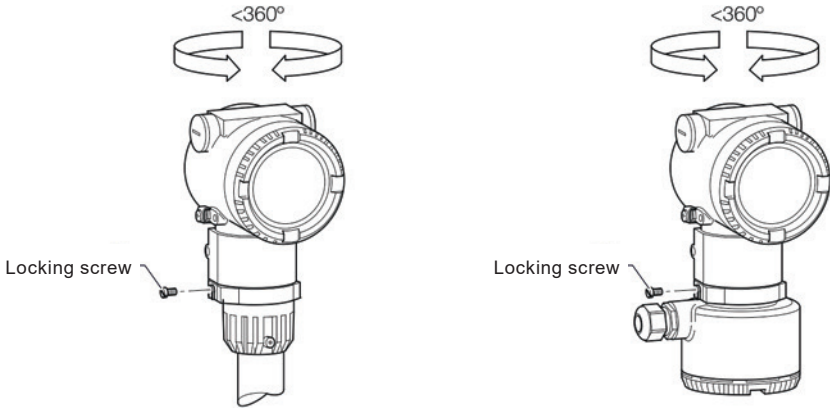

- Loosen the locking screw on the transmitter housing using a 4 mm Allen key.
- Rotate the transmitter housing in the direction required.
- Tighten the locking screw.

Fig. 16 Rotating the transmitter housing

3.12 Rotating the LCD indicator

	<p>Warning! Risk of injury due to live parts! When the housing is open, contact protection is not provided and EMC protection is limited.</p> <ul style="list-style-type: none">- Before opening the housing, switch off the power supply.
--	--

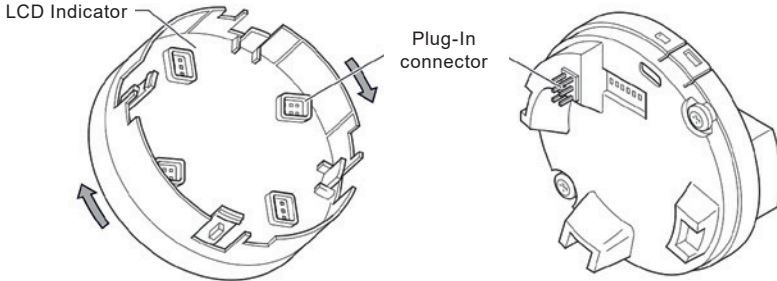

The LCD indicator can be rotated in 90° increments to make it easier to read and operate.

- Unscrew the front housing cover.
- Pull out the LCD indicator and place it in the desired position.
- Tighten the screws on the front of the housing cover handtight.

Fig. 17 Rotating the LCD indicator

	<p>NOTE Potential adverse effect on the IP rating! If the O-ring gasket is seated incorrectly or is damaged, this may have an adverse effect on the IP rating.</p> <ul style="list-style-type: none">- Check that the O-ring gasket is properly seated when closing the housing cover.
--	--

3.13 Opening and closing the housing

	<p>Warning! Risk of injury due to live parts. Improper work on the electrical connections can result in electric shock.</p> <ul style="list-style-type: none">- Connect the device only with the power supply switched off.- Observe the applicable standards and regulations for the electrical connection.
--	---

	<p>NOTE Potential adverse effect on the IP rating! If the O-ring gasket is seated incorrectly or is damaged, this may have an adverse effect on the IP rating.</p> <ul style="list-style-type: none">- Check that the O-ring gasket is properly seated when closing the housing cover.
--	--

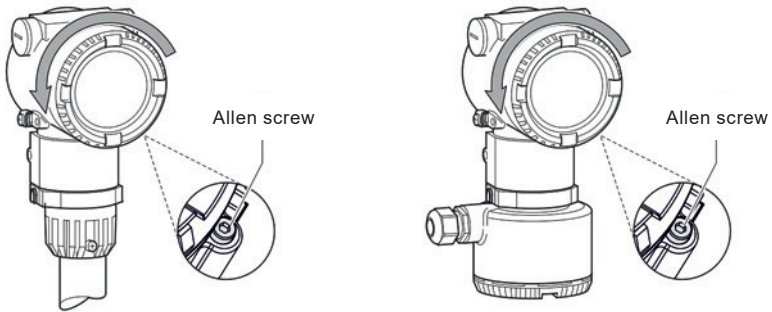

Fig. 18 Cover lock (example)

To open the housing, release the cover lock by screwing in the Allen screw.
After closing the housing, lock the housing cover by unscrewing the Allen screw.

Note: After several weeks, increased force will be required to unscrew the housing cover. This is not caused by the threads, but instead is due to the type of gasket.

The electrical connection may only be established by authorised specialist personnel and in accordance with the connection diagrams.

The electrical connection information in this manual must be observed; otherwise, the IP rating may be adversely affected. Ground the measurement system according to requirements.

3.14 Signal Cables

For devices with a remote mount design, the transmitter and sensor are connected using a signal cable. The signal cable used must meet at least the following technical specification.

Cable specification	
Impedance	70 to 120 Ω
Withstand voltage	500 V
Outer diameter	6 to 12 mm (0.24 to 0.47")
Cable design	3 × 2 × 0.75 mm ² , twisted pair.
Conductor cross-section	0.75 mm ²
Shield	Copper braid with approximately 85% coverage.
Temperature range	Application-dependent.
Maximum signal cable length	30 m (98 ft)

3.15 Installing the connection cables

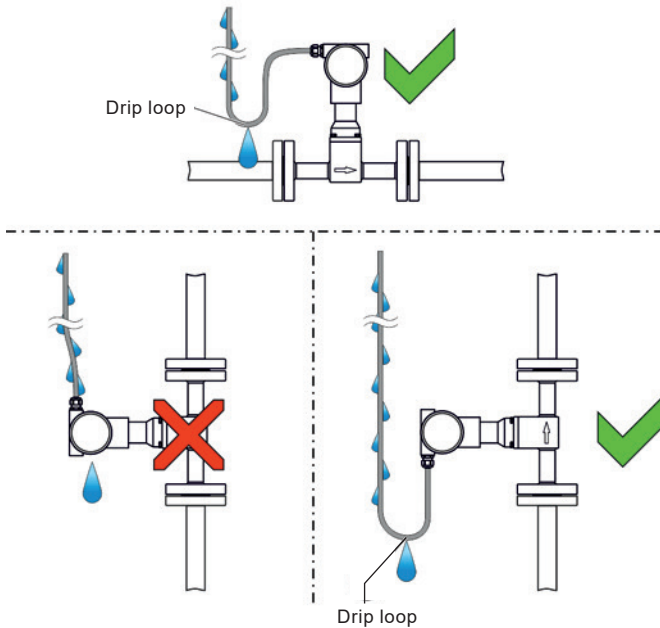

Fig. 19 Laying the connection cable

3.16 Cable glands

We do not supply cable glands as standard as part of our strive towards sustainability. Suitable glands or blanking plugs to fit either M20 x 1.5 or ½" NPT thread will need to be purchased separately and used on the unit, as it will not meet it's IP rating if they are not fitted.

3.17 Grounding

	<p>NOTE Impact on measurement The measurement may be impacted by external electric disruptions (EMC disruptions).</p> <ul style="list-style-type: none">- Ground the device as shown to avoid impact on the measurement by external electric disruptions (EMC disruptions).
--	---

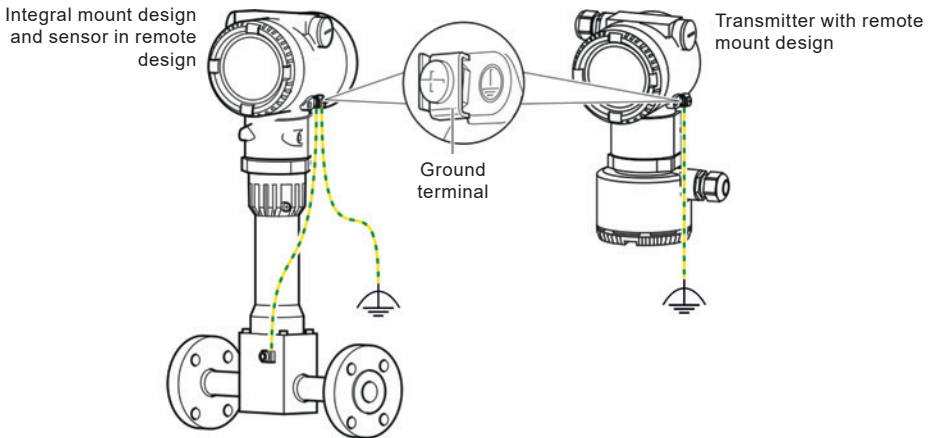

Fig. 20 Ground Terminals

For the earthing (PE) of the transmitter or the connection of a protective earth, a connection is available both on the exterior of the housing and in the connection space. Both connections must be galvanically connected to one another. To avoid potential differences, a 3-point grounding as shown in Figure 20 is recommended. These connection points can be used if grounding or the connection of a protective conductor is prescribed by national regulations for the selected type of supply or the type of protection used.

- Loosen the screw terminal on the transmitter housing or on the housing of the VLM30.
- Insert the forked cable lug for functional grounding between the two metal tabs and into the loosened terminal.
- Tighten the screw terminal.

3.18 Devices with HART® communication

Note: The HART protocol is an unsecured protocol, as such the intended application should be assessed to ensure that these protocols are suitable before implementation.

3.18.1 Current output/HART® output

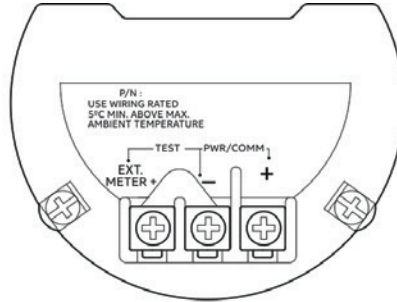

Fig. 21 Terminals VLM30S (without binary output)

Terminal	Function/comment
PWR/COMM+	Power supply, current
PWR/COMM -	output-/HART output
EXT. METER	Not assigned

3.18.2 Current output/HART® output, digital output and analog input

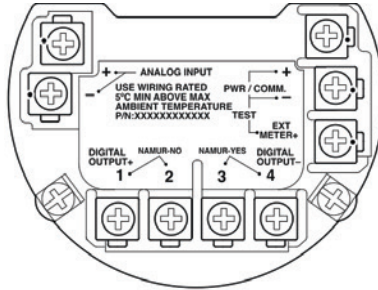

Fig. 22 Terminals for VLM30S and VLM30E with binary output

Terminal	Function/comment
PWR/COMM+	Power supply, current.
PWR/COMM -	Output-/HART® output.
EXT. METER	Not assigned.
DIGITAL OUTPUT 1+	Digital output, positive pole.
DIGITAL OUTPUT 2	Bridge after terminal 1+, NAMUR output deactivated.
DIGITAL OUTPUT 3	Bridge after terminal 4-, NAMUR output activated.
DIGITAL OUTPUT 4-	Digital output, negative pole.

3.18.3 Power Supply

Devices with HART® communication	
Terminals	PWR/COMM +/PWR/COMM -
Supply voltage	12 to 42 Vdc
Residual ripple	Maximum 5% or $U_{ss} = \pm 1.5$ V
Power consumption	< 1 W
U_{ss} Peak-to-peak value of voltage	

3.18.4 Current output/HART® output

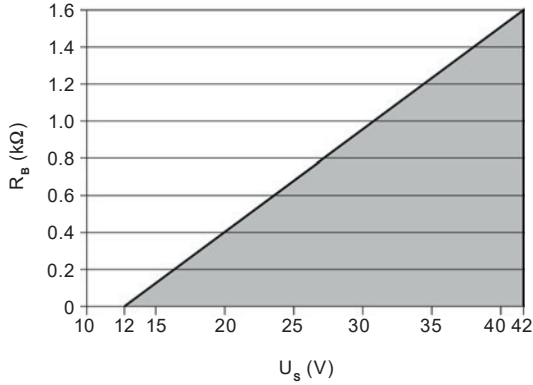

Fig. 23 Load diagram of current output; load depending on supply voltage

Devices with HART® communication

Terminals PWR/COMM +/PWR/COMM -

Minimal Load R_b 250 Ω

The load R_b is calculated as a function of the available supply voltage U_s and the selected signal current I_b as follows:

$$R_b = U_s / I_b$$

R_b Load resistance

U_s Supply voltage

I_b Signalstrom

3.18.5 Low flow cut-off

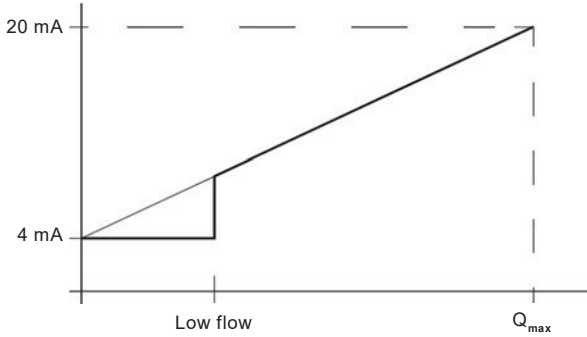

Fig. 24 Behaviour of the current output

The current output behaves as shown in the figure above.
Above the low flow, the current curve proceeds as a straight line in accordance with the flow rate.

- Flow rate = 0, current output = 4 mA
- Flow rate = Q_{max} , current output = 20 mA

If the low flow cut-off is activated, flow rates below the low flow are set to 0 and the current output set to 4 mA.

3.18.6 Analog input 4 to 20 mA

Only for devices with HART® communication

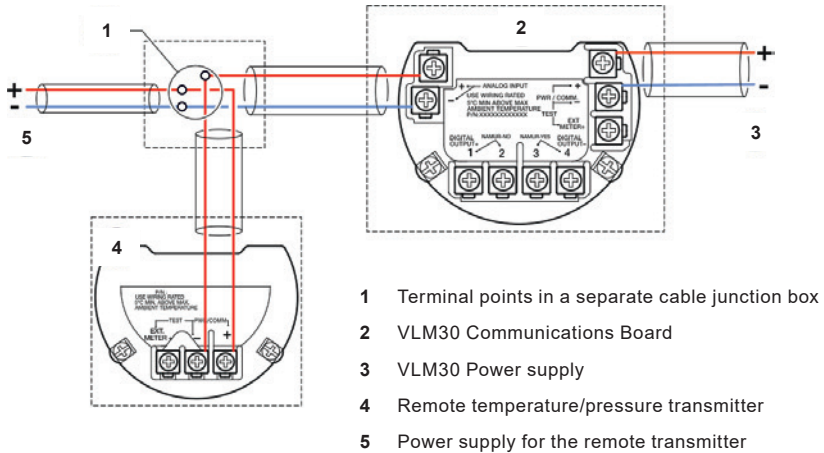

Fig. 25 Connection of transmitters to analog input (example)

Analog input 4 to 20 ma

Terminals	ANALOG INPUT+/ANALOG INPUT-
Operating voltage	16 to 30 Vdc
Input current	3.8 to 20.5 mA
Equivalent resistance	90 Ω

A remote transmitter with current output from 4 to 20 mA can be connected to the analog input:

- Temperature transmitter
- Pressure transmitter

The analog input can be configured using the relevant software:

- Input for the pressure measurement for pressure compensation for the flow measurement of gases and vapor.
- Input for the return temperature measurement for energy measurement.

3.18.7 HART® communication with remote transmitter

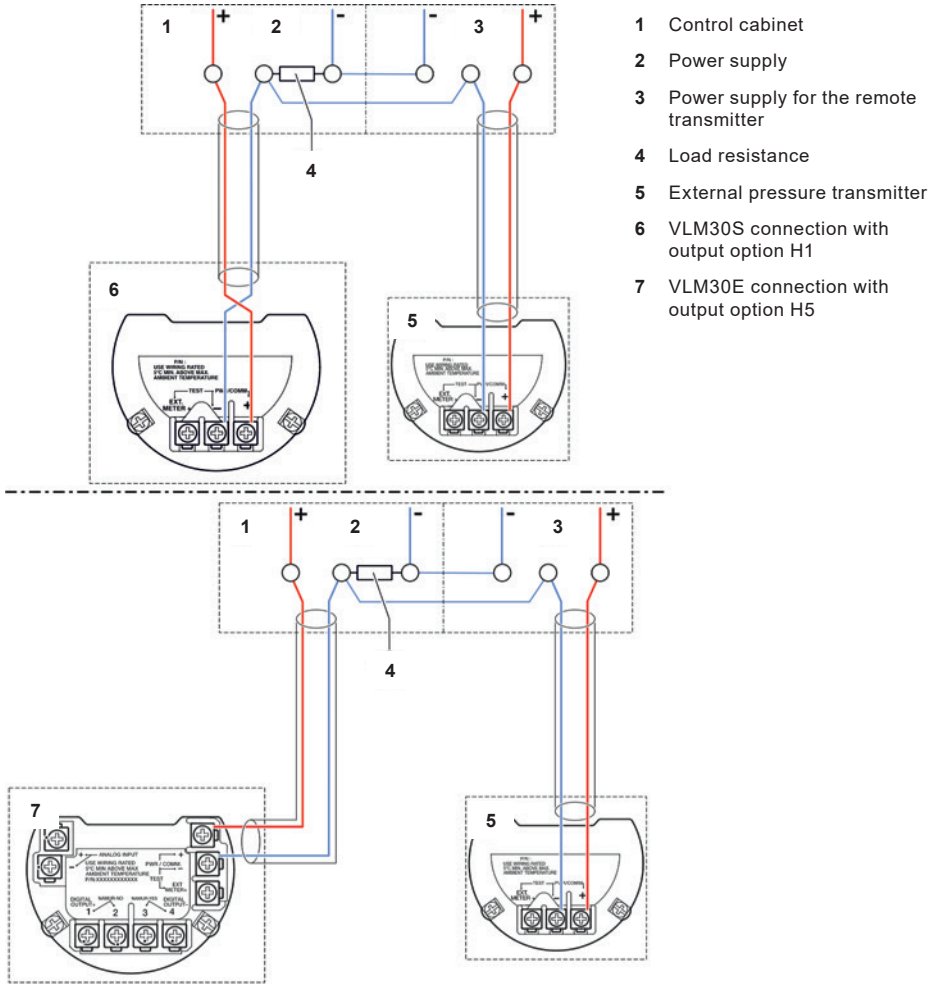

Fig. 26 Connection of transmitters with HART communication (example)

A remote pressure transmitter with HART communication can be connected through the current output/HART output (4 to 20 mA). Here, the remote transmitter must be operated in HART Burst mode, with the 'P6 – HART Burst Mode' ordering option. The VLM30 supports HART communication up to the HART7 protocol.

Note: The VLM30 cannot communicate with a control system or configuration tool via HART while the pressure transmitter is communicating in BURST mode, because the BURST signal has priority over cyclical HART communication.

3.18.8 HART® communication connection example

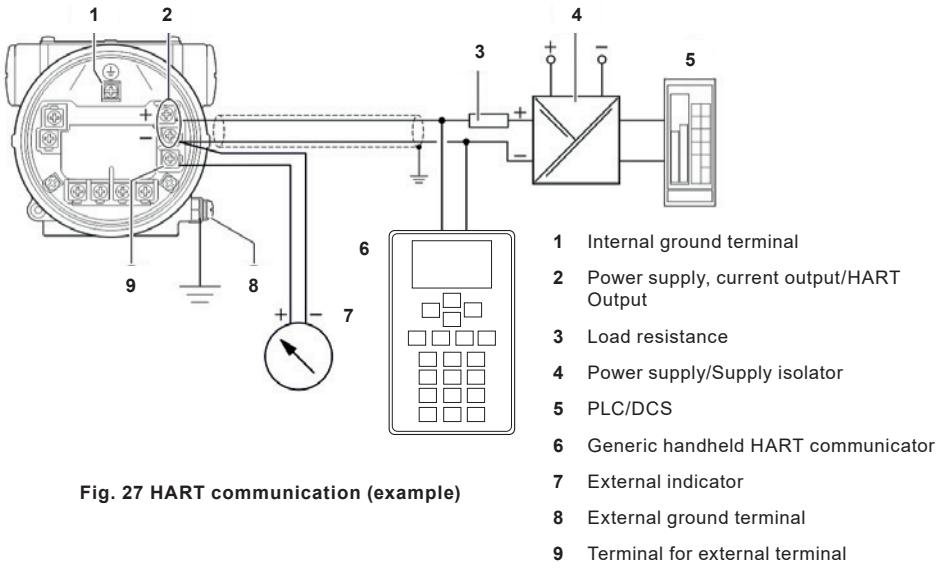

Fig. 27 HART communication (example)

For connecting the signal voltage/supply voltage, twisted cables with a conductor cross-section of 18 to 22 AWG/0.8 to 0.35 mm² and a maximum length of 1500 m (4921 ft) must be used. For longer leads a greater cable cross section is required. For shielded cables the cable shielding must only be placed on one side (not on both sides). For the earthing on the transmitter, the inner terminal with the corresponding marking can also be used.

The output signal (4 to 20 mA) and the power supply are conducted via the same conductor pair.

The transmitter works with a supply voltage between 12 and 42 Vdc.

Note: Any configuration changes are saved in sensor memory only if no HART communication is taking place. To securely save any changes, make sure that HART communication has ended before the device is disconnected from power. The possible lead length depends on the total capacity and the total resistance and can be estimated based on the following formula.

$$L = \frac{65 \times 106}{R \times C} - \frac{C_i + 1000}{C}$$

L	Lead length in meters
R	Total resistance in Ω
C	Lead capacity
C _i	Maximum internal capacity in pF of the HART field devices in the circuit

Avoid installing the cable together with other power leads (with inductive load, etc.), as well as the vicinity to large electrical installations. The HART Handheld terminal can be connected to any connection point in the circuit if a resistance of at least 250 Ω is present in the circuit. If there is resistance of less than 250 Ω, an additional resistor must be provided to enable communication. The handheld terminal is connected between the resistor and transmitter, not between the resistor and the power supply.

3.19 Devices with Modbus[®] communication

3.19.1 Terminals

Note: The Modbus protocol is an unsecured protocol, as such the intended application should be assessed to ensure that these protocols are suitable before implementation.

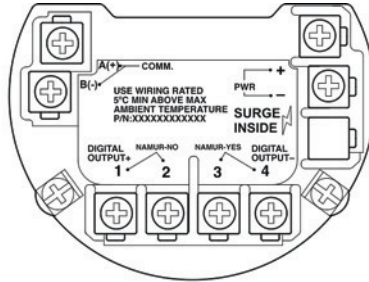

Fig. 28 VLM30S Terminals

Terminal	Function/comment
PWR +	Power supply.
PWR -	
A (+)	Modbus [®] interface RS485.
B (-)	
DIGITAL OUTPUT 1+	Digital output, positive pole.
DIGITAL OUTPUT 2	Bridge after terminal 1+, NAMUR output deactivated.
DIGITAL OUTPUT 3	Bridge after terminal 4-, NAMUR output activated.
DIGITAL OUTPUT 4-	Digital output, negative pole.

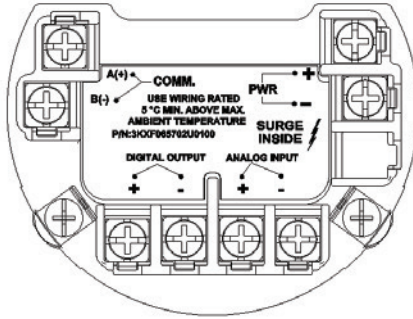

Fig. 29 VLM30E Terminals

Terminal	Function/comment
PWR +	Power supply.
PWR -	
A (+)	Modbus [®] interface RS485.
B (-)	
DIGITAL OUTPUT 1+	Digital output, positive pole.
DIGITAL OUTPUT -	Digital output, negative pole.
DIGITAL OUTPUT +	Analog output, positive pole.
DIGITAL OUTPUT -	Analog input, negative pole.

3.19.2 Power Supply

Devices with Modbus[®] communication

Terminals	PWR +/PWR -
Supply voltage	9 to 30 Vdc
Residual ripple	Maximum 5% or $U_{ss} = \pm 1.5$ V
Power consumption	< 1 W

U_{ss} Peak-to-peak value of voltage

3.19.3 Modbus[®] communication

Using the Modbus protocol allows devices made by different manufacturers to exchange information via the same communication bus, without the need for any special interface devices to be used. Up to 32 devices can be connected on one Modbus line. The Modbus network can be expanded using repeaters.

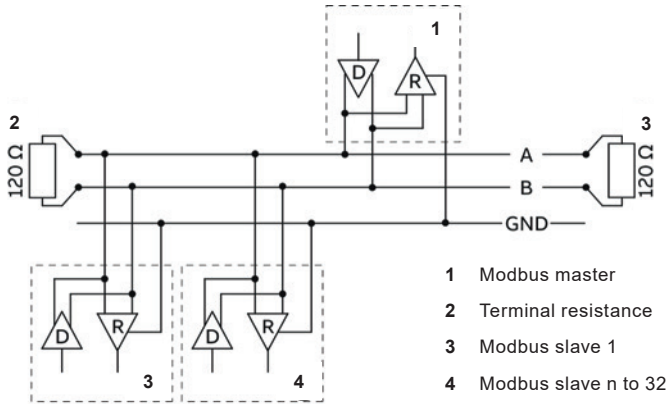

Fig. 30 Modbus network (Example)

Modbus interface

Configuration	Via the Modbus [®] interface in connection with Device Type Manager (DTM).
Transmission	Modbus [®] RTU - RS485 serial connection.
Baud rate	1200, 2400, 4800, 9600 bps Factory setting: 9600 bps
Parity	None, even, odd Factory setting: none
Typical response time	< 100 milliseconds.
Response delay time	0 to 200 milliseconds. Factory setting: 50 milliseconds.
Device address	1 to 247. Factory setting: 247.
Registered address offset	One base, Zero base. Factory setting: One base.

3.20 Cable specification

The maximum permissible length depends on the baud rate, the cable (diameter, capacity and surge impedance), the number of loads in the device chain, and the network configuration (2-core or 4-core).

- At a baud rate of 9600 and with a conductor cross-section of at least 0.14 mm² (AWG 26), the maximum length is 1000 m (3280 ft).
- If a four-core cable is used in a two-wire system, the maximum length must be divided in half.
- The spur lines must be short (maximum of 20 m (66 ft)).
- When using a distributor with 'n' connections, the maximum length of each branch is calculated as follows: 40 m (131 ft) divided by 'n'.

The maximum cable length depends on the type of cable used. The following standard values apply:

- Up to 6 m (20 ft): cable with standard shielding or twisted-pair cable.
- Up to 300 m (984 ft): double twisted-pair cable with overall foil shielding and integrated earth cable.
- Up to 1200 m (3937 ft): double twisted-pair cable with individual foil shielding and integrated earth cables.

Example: Belden 9729 or equivalent cable.

A category 5 cable can be used for Modbus[®] RS485 up to a maximum length of 600 m (1968 ft). For the symmetrical pairs in RS485 systems, a surge impedance of more than 100 Ω is preferred, especially at a baud rate of 19200 and above.

3.21 Connection to remote mount design

	<p>NOTE Impairment of the device function Impairment of the device function due to incorrect allocation of sensor and transmitter. Correct allocation can be identified via the serial number on the name plate.</p> <ul style="list-style-type: none">- Make sure that the sensor and transmitter are correctly allocated.
---	---

The signal cable connects the measuring sensor to the transmitter. The cable is fixed to the transmitter, however, it can be separated as needed. When laying the signal cable, observe the following points:

- Install the signal cable in the shortest path between the measuring sensor and the transmitter. Shorten the signal cable accordingly as needed.
- The maximum permissible signal cable length is 30 m (99 ft).
- Avoid installing the signal cable in the vicinity of electric equipment or switching elements that can create strayfields, switching pulses and magnetic induction. If this is not possible, run the signal cable through a metal pipe and connect this to operational ground.
- Carry out all terminal connections carefully.
- Lay the wires in the terminal box in such a way that they are not affected by vibrations.

3.21.1 Producing a signal cable

The signal cable is available in four standard lengths: 5 m (16.4 ft), 10 m (32.8 ft), 20 m (65.6 ft) and 30 m (98.4 ft). The cable ends are already prepared for installation.

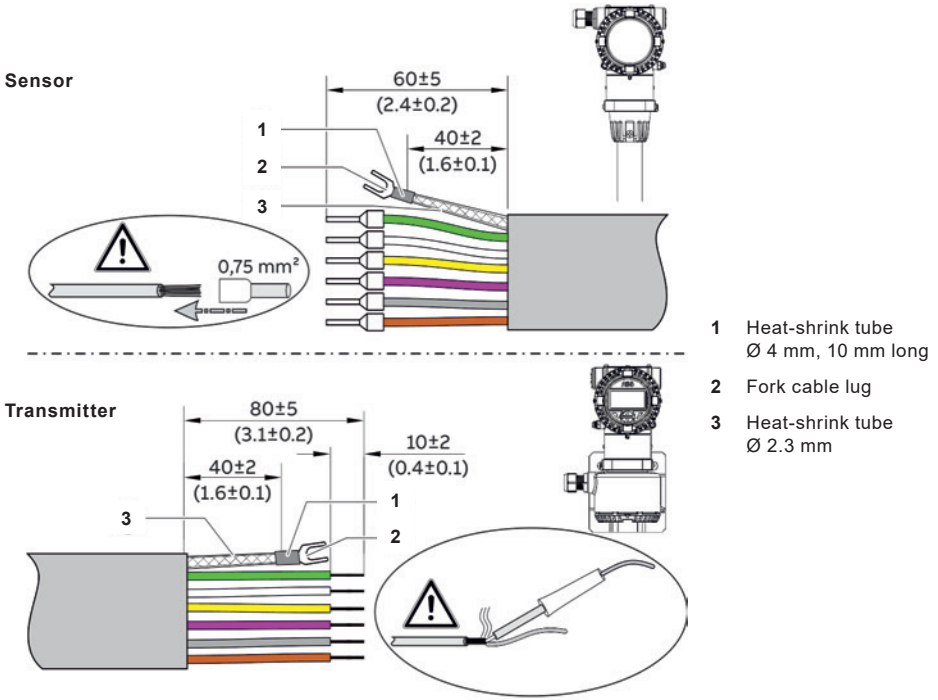

Fig. 31 Signal cable, dimensions in mm (")

The signal cable can also be cut to any length. Then the cable ends must be prepared as shown in Figure 31.

- Twist the shield, shorten and insulate with heat-shrink tube 3. Crimp a matching forked cable lug 2 and insulate the crimping with a heat-shrink tube 1.
- Attach wire-end ferrules (0.75 mm²) to the wires on the sensor side.
- Twist the wires on the transmitter side and solder.

3.21.2 Connecting the signal cable



NOTE

Damage to components!

- The transmitter housing must not be lifted without pulling out the cable, otherwise the cable can tear off.
- The transmitter housing must not be rotated more than 360 degrees.

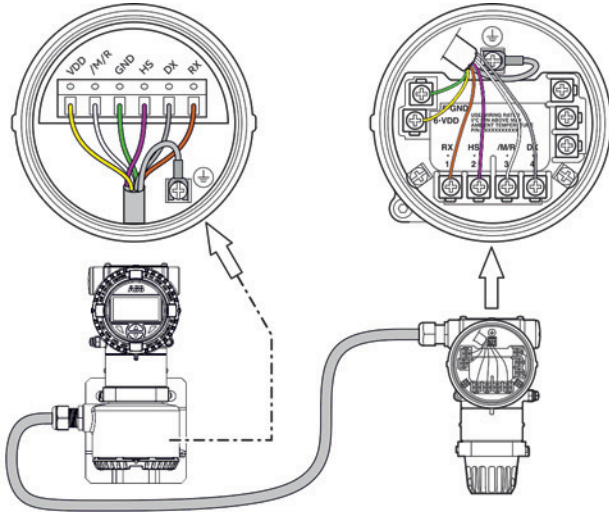



Fig. 32 Electrical connection

Terminal	Color/function
VDD	Yellow
/M/R	White
GND	Green
HS	Pink
DX	Grey
RX	Brown
	Ground terminal (functional ground/shield)

Note: The shielding of the signal cable also serves as a functional ground and must be connected to the sensor and to the transmitter on both sides.

- Use the signal cable connected to the transmitter to make the electrical connection between the measuring sensor and the transmitter.
- Unscrew the cover of the terminal boxes on the transmitter and the measuring sensor.
- Produce the signal cable in accordance with the specification (see Figure 31).
- Insert the cable through the cable gland into the terminal box.
- Tighten the cable gland.
- Connect the wires to the corresponding terminals (see Figure 32).
- Connect the shield of the signal cable to the forked cable lug to the ground terminal.
- Screw on the cover of the terminal compartment on the transmitter and the measuring sensor and tighten by hand. Make sure the gaskets for the cover are seated properly.

4. Commissioning

4.1 Safety instructions

	<p>Danger! Danger of explosion if the device is operated with the transmitter housing or terminal box open! Before opening the transmitter housing or the terminal box, note the following points:</p> <ul style="list-style-type: none">- Check that a valid fire permit is available.- Make sure that there is no explosion hazard.- Before opening the device, switch off the power supply and wait for $t > 2$ minutes.
---	---

	<p>Caution! Risk of burns due to hot measuring media The device surface temperature may exceed 70 °C (158 °F), depending on the measuring medium temperature!</p> <ul style="list-style-type: none">- Before starting work on the device, make sure that it has cooled sufficiently.
---	--

4.2 General

The commissioning of the device depends on the communication version (HART & Modbus).

Commissioning is divided into a general part and fieldbus-dependent information.

General commissioning

The following chapters address general commissioning:

- Checks prior to commissioning in Section 4.4
- Power Supply Power-Up on in Section 4.5
- Checking and configuring the basic settings in Section 4.7

Commissioning of devices with HART and Modbus communication see Section **4.9 Devices with HART and Modbus communication**.

4.3 Digital output

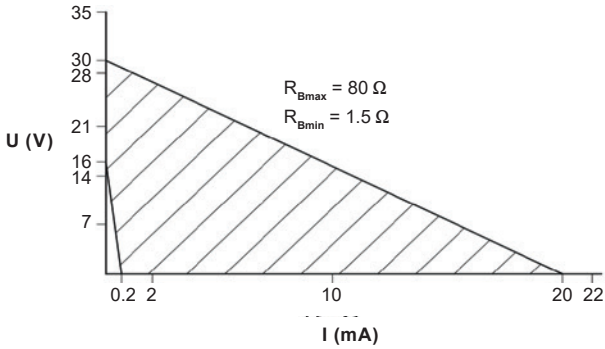

Fig. 33 Range of the external supply voltage and current

Digital output	
Operating voltage	16 to 30 Vdc
Output current	maximum 20 mA
External resistance R_B	$1.5 \text{ k}\Omega \leq R_B \leq 80 \text{ k}\Omega$
Output 'closed'	$0 \text{ V} \leq U_{low} \leq 2 \text{ V}$ $2 \text{ mA} \leq I_{low} \leq 20 \text{ mA}$
Output 'open'	$16 \text{ V} \leq U_{high} \leq 30 \text{ V}$ $0 \text{ mA} \leq I_{high} \leq 0.2 \text{ mA}$
Pulse output	f_{max} : 10 kHz Pulse width: 0.05 to 2000 ms
Frequency output	f_{max} : 10.5 kHz
Output functions (configurable)	Frequency output. Pulse output. Binary output (in/out, e.g. alarm signal).

It is possible to use software to configure the optional digital output as an alarm, frequency or pulse output. It is possible to use a bridge to configure the digital output as an optoelectronic coupler output or a NAMUR output.

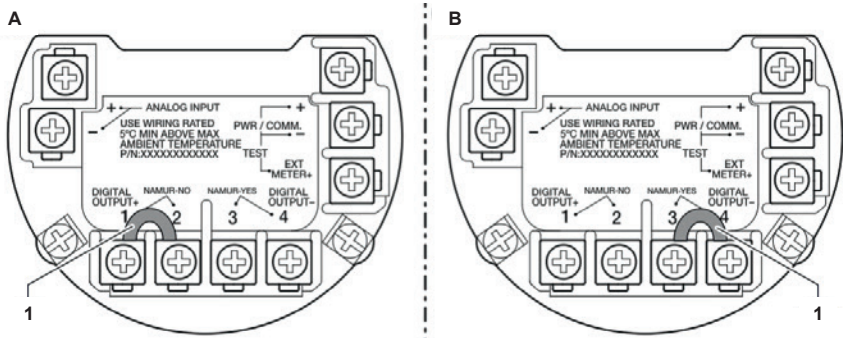

Fig. 34 Hardware configuration of the digital output

Output configuration	Bridge
Optoelectronic coupler output	1-2
NAMUR output	3-4

In the factory setting, the output is configured as an optoelectronic coupler output.

Note

The type of protection of the outputs remains unchanged, regardless of the output configuration. The devices connected to the digital output must conform to the current regulations for explosion protection.

4.4 Checks prior to commissioning

The following points must be checked before commissioning:

- The power supply must be switched off.
- The power supply used must match the information on the name plate.
- Correct wiring in accordance with Electrical connections in Section 3.14 to 3.22.
- Correct grounding in accordance with Grounding in Section 3.7.
- The ambient conditions must meet the requirements set out in the specification.
- The transmitter must be installed at a location largely free of vibrations.
- The housing cover and cover lock must be sealed before powering-up the power supply.
- For devices with a remote mount design, make sure that the sensor and transmitter are assigned correctly.

4.5 Power Supply Power-Up

- Switch on the device power supply.
After switching on the power supply, the system data in the SensorMemory is compared with the values stored internally in the transmitter.
- If the system data is not identical, it is matched automatically.
- The flowmeter is now ready for operation.
- The LCD display shows the process display.

4.6 Checks after switching on the power supply

The following must be checked after commissioning the device:

- Parameter configuration must correspond to the operating conditions.
- The system zero point is stable.
If this is not the case, a zero point balance must be carried out (see Section 5.12 **Zero point balance under operating conditions**).

4.7 Checking and configuring the basic settings

The device can be factory parameterised to customer specifications upon request. If no customer information is available, the device is delivered with factory settings.

Parameter	Factory setting
Active Mode	Liquid Volume
Output Value	Flow rate
DO Function	No function
Q_{max}	Actual value set to Q_{max} DN. Depending on the nominal diameter of the flowmeter.
Unit Q	m ³ /h
Analog In Value	No function
HART In Value	No function
Low Flow Cutoff	4%
Iout at Alarm	Low Alarm Value
Low Alarm Value	3.55 mA
High Alarm Value	22 mA

4.8 Parameterisation via the menu function Easy Setup

Settings for the most common parameters are summarised in the 'Easy Setup' menu. This menu provides the fastest way to configure the device. The next respective parameter is called out by  (Next).

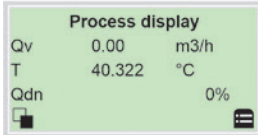

Note: The LCD display is provided with capacitive control buttons. These enable you to control the device through the closed housing cover.

4.8.1 Open the Menu Easy Setup



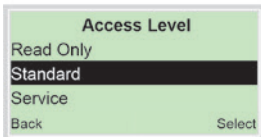

1. Switch to the configuration level using .

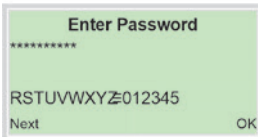

2. Use / 'Standard' to make the selection.

3. Confirm the selection with .



4. Use  to confirm the password. A password is not available as factory default; you can continue without entering a password.

Note: For security reasons it is recommended, to set a password.

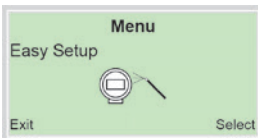





5. Use / 'Easy Setup' to make the selection.

6. Confirm the selection with .

4.8.2 Selection of the menu language





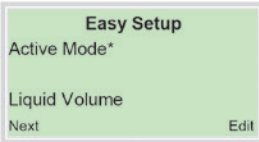

1. Use  to call up the edit mode.
2. Use  /  to select the desired language.
3. Confirm the selection with .

4.8.3 Select the operating mode

For more information on the operating mode, refer to Section 4.9.8 Operating modes.





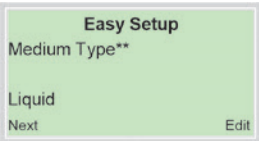

1. Use  to call up the edit mode.
2. Use  /  to select the desired operating mode.
3. Confirm the selection with .

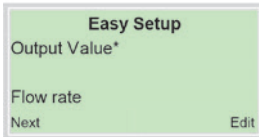

4.8.4 Configuration of the current output

Only for devices with HART communication!



1. Use  to call up the edit mode.
2. Use  /  to select the desired language.
3. Confirm the selection with .

4.8.5 Configuration of the digital output

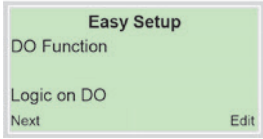

1. Use to call up the edit mode.
2. Use to select the desired operating mode for the digital output.
 - Logic on DO: Operation as a switch output.
 - Pulse on DO: In pulse mode, pulses are emitted per unit.
 - Freq on DO: In frequency mode, a frequency proportional to the flow is emitted.
3. Confirm the selection with .

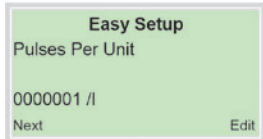

4. Use to call up the edit mode.

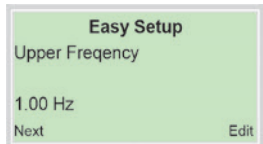

5. With the use of , set the pulses per unit (Pulse on DO) or the upper frequency (Freq on DO).
6. Confirm the selection with .

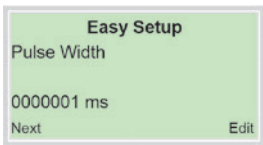

7. Use to call up the edit mode.
8. With the use of , set the pulse width (Pulse on DO) or the lower frequency (Freq on DO).

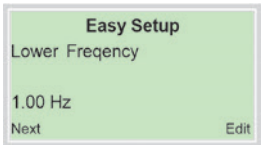

9. Confirm the selection with .

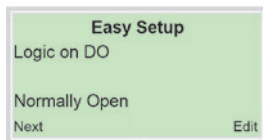

10. Use to call up the edit mode.
11. Select the switching behavior for the binary output using .
12. Confirm the selection with .

4.8.6 Selection of the units

In the following menus, the units for the following process values are selected: volume, mass, standard volume, power, density, temperature, pressure, volume flowmeter, mass flowmeter, standard volume flowmeter and energy meter.

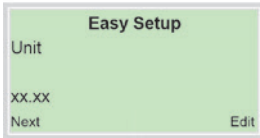

1. Use to call up the edit mode.
2. Use to select the desired unit for the respective process value.
3. Confirm the selection with .

4.8.7 Configuration of the analog/HART input

Only for devices with HART communication!

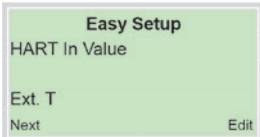

1. Use to call up the edit mode.
2. Use to select the desired function for the analog/HART input.

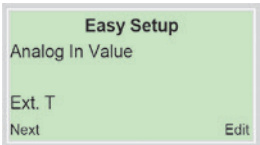



HART In Value	Analog In Value	Function
Ext. T	Ext. T	External temperature transmitter downstream for energy measurement.
Pressure	Pressure	External pressure transmitter.
Gas Content	Gas Content	External gas analyser.
Density	Density	External density transmitter.
Int.T	Int.T	External temperature transmitter upstream for energy measurement.
-	Ext. Cutoff	External output zero return.

3. Confirm the selection with .

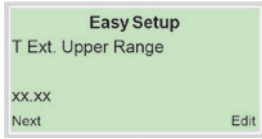
In the following menus, the measurement range limits for the external transmitters are fixed at the analog input.



4. Use  to call up the edit mode.
5. Use  to set the measuring range limits for the respective process value.
6. Confirm the selection with .

Upper value = 20 mA
Lower value = 4 mA

Configuration of the parameters dependent on the operating mode

Only for devices with HART communication!



The parameters shown in this position in the menu depend on the selected operating mode and are not presented in detail here. Refer to Section 4.9.8 Operating modes and Section 5.10 Parameter descriptions for detailed information!

4.8.8 Select the end value for the current output

Only for devices with HART communication!

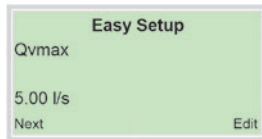
Setting of the flow rate or energy quantity at which the current output is to output 20 mA (100%). The value entered must be at least 15% of $Q_{max DN}$.





1. Use  to call up the edit mode.
2. Use  to select the desired unit for the current output.
3. Confirm the selection with .

4.8.9 Adjusting the damping value

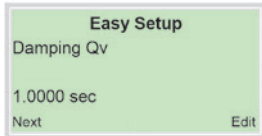
Adjustment of the damping for the respective process value [the value relates to 1 T (Tau)]. The damping relates to a step change in the flow rate or energy quantity or temperature. The damping affects the instantaneous value in the process display and at the current output.



1. Use  to call up the edit mode.
2. Use  to set the desired damping for the respective process value.
3. Confirm the selection with .

4.8.10 Configuration of the alarm signaling via the current output

Only for devices with HART communication!

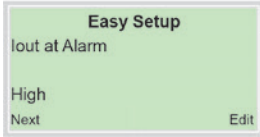

1. Use to call up the edit mode.
2. Adjust the desired state 'high' or 'low' in case of faults using /.
3. Confirm the selection with .



4. Use to call up the edit mode.
5. Use // to set the alarm current.

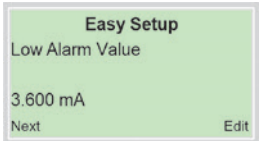

6. Confirm the selection with .

4.8.11 Zero point adjustment of the flowmeter

Note: Prior to starting the zero point adjustment, make sure that:



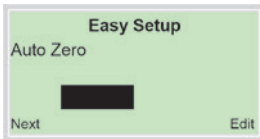

- There is no flow through the sensor (close all valves, shut-off devices etc.)
- The sensor must be completely filled with the medium to be measured.

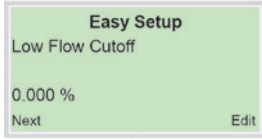

- Use to start automatic adjustment of the zero point for the system.

4.8.12 Configuration of the low flow cut-off



1. Use  to call up the edit mode.
2. Use // to set the desired value for the low flow cut-off.
3. Confirm the selection with .

Once all parameter have been set, the main menu appears again. The most important parameters are now set.

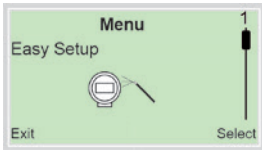

4. Use  to switch to the process display.

4.9 Devices with HART® and Modbus® communication.

4.9.1 Hardware Settings

Current output 4 to 20 mA/HART

In the factory setting, the flow signal is emitted via the current output of 4 to 20 mA. Alternatively, the temperature signal can be assigned to the current output.

External devices can be connected to the passive analog input (4 to 20 mA).

The function of the analog input can be selected via the software ('Input/Output' menu).

The analog input can be configured via the 'Easy Setup' menu or the setup menu of the device. Before starting the configuration, select the type of the connected signal and then select the values for 4 mA and 20 mA that correspond to the relevant output values of the connected device.

4.9.2 HART® Input

Only for devices with HART communication!

The HART input can be configured via the 'Easy Setup' menu or the setup menu of the device.

The device recognises the value and the corresponding unit via the HART input.

The remote transmitter must be operated in HART burst mode.

If, for example, the pressure unit is set to psi in the setup menu of the device but the pressure unit of the connected pressure transmitter is set to kPa, the VLM30 takes the pressure unit from the pressure transmitter.

4.9.3 DIP switch on the HART® communication board

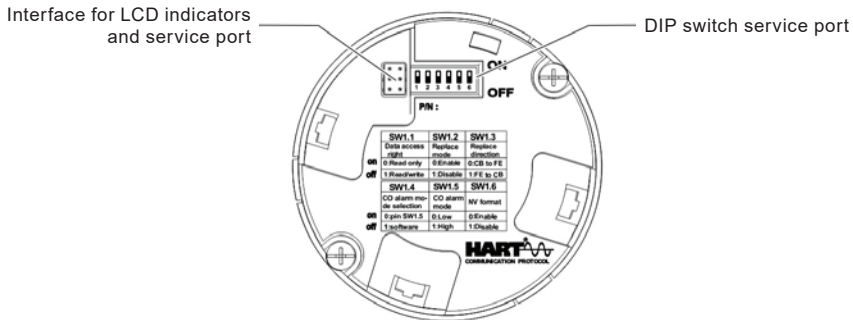

Fig. 35 HART® communication board/4 to 20 mA

DIP switch	Function
SW 1.1	Write protection switch.
	On: Write protection active.
	Off: Write protection deactivated.
SW 1.2	Replacement mode (transfer system data).
	On: Replacement mode active.
	Off: Replacement mode deactivated.
SW 1.3	System data transfer direction.
	On: Transmitter -> sensor.
	Off: Sensor -> transmitter.
SW 1.4	Selection whether the alarm function is configured via software or DIP switch.
	On: Selection of alarm current via SW 1.5.
	Off: Selection of alarm current via the 'Input/Output/Out at Alarm' menu.
SW 1.5	Selection of alarm current.
	On: Low alarm (3.5 to 3.6 mA).
	Off: High alarm (21.0 to 22.6 mA).
SW 1.6	Format SensorMemory.
	Service function! - Risk of data loss in the device.

The communication board is located behind the front housing cover. The LCD indicator may have to be removed to provide access to the DIP switches.

The DIP switches are used to configure specific hardware functions. The power supply to the transmitter must be briefly interrupted in order for the modified setting to take effect.

The interface for the LCD indicator is also used as the service port for device configuration.

Write-protect switch

When write protection is activated, device parameterisation cannot be changed via HART or the LCD indicator. Activating and sealing the write protection switch protects the device against tampering.

Downloading system data, replacing the transmitter

When replacing transmitter components (communication board), system data must be downloaded from the SensorMemory.

Download of system data and the system data transfer direction is activated using DIP switches SW 1.2 and SW 1.3.

Refer to **Replacing the transmitter**, downloading system data in Section 8.

Status of the current output

DIP switches SW 1.4 and SW 1.5 can be used to configure the status of the current output in the event of an alarm/error. If the current in the event of an alarm is selected via DIP switch SW 1.5, the setting can no longer be changed using HART or the LCD indicator.

4.9.4 DIP switch on the Modbus® communication board

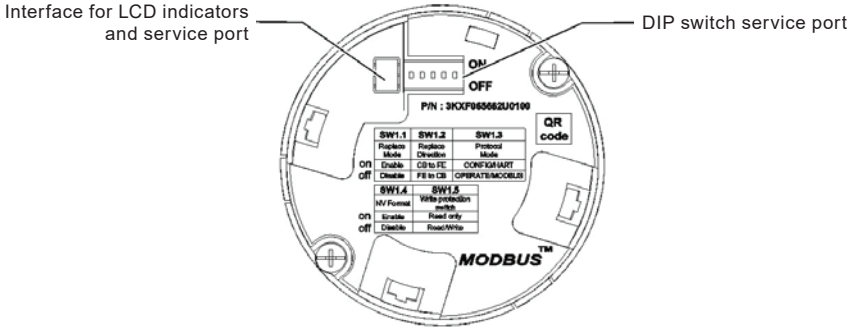

Fig. 36 Modbus® communication board

DIP switch	Function	DIP switch	Function
SW 1.1	Replacement mode (transfer system data).	SW 1.4	Format SensorMemory.
	On: Replacement mode active.		Service function! – Risk of data loss in the device.
SW 1.2	Off: Replacement mode deactivated.	SW 1.5	Write protection switch.
	System data transfer direction.		On: Write protection active.
SW 1.3	On: Transmitter -> sensor.	Off: Write protection deactivated.	
	Off: Sensor -> transmitter.		
	Protocol mode.		
	On: CONFIG/HART protocol.		
	Off: OPERATE/MODBUS protocol.		

The communication board is located behind the front housing cover. The LCD indicator may have to be removed to provide access to the DIP switches.

The DIP switches are used to configure specific hardware functions. The power supply to the transmitter must be briefly interrupted in order for the modified setting to take effect. The interface for the LCD indicator is also used as the service port for device configuration.

Write-protect switch

If write protection is active, the device parameterisation cannot be changed. Activating and sealing the write protection switch protects the device against tampering.

Downloading system data, replacing the transmitter

When replacing transmitter components (communication board), system data must be downloaded from the SensorMemory.

Loading system data and the system data transfer direction is activated using DIP switches SW 1.1 and SW 1.2. Refer to **Replacing the transmitter, downloading system data** in Section 8.

4.9.5 Factory settings of HART® Variables PV, SV, TV and QV depending on the operating mode

The following table shows the factory default assignment of process variables to the HART variables (PV, SV, TV or Qv) depending on operating mode.

Operating mode	HART variables			
	PV	SV	TV	QV
Liquid Volume	Operating volumes	Temperature	Totaliser volumes	-
Liquid Std/Norm Vol.	Standard volume	Temperature	Standard volume counter	Operating volumes
Liquid Mass	Mass	Temperature	Totaliser mass	Operating volumes
Liquid Energy	Energy	Temperature	Energy counter	Operating volumes
Gas Act. Volume	Operating volumes	Temperature	Totaliser volumes	-
Gas Std/Norm Vol.	Standard volume	Temperature	Standard volume counter	Operating volumes
Gas Mass	Mass	Temperature	Totaliser mass	Operating volumes
Gas Power	Energy	Temperature	Energy counter	Operating volumes
Bio Act. Volume	Partial operating volumes	Temperature	Partial volume counter	Operating volumes
Bio Std/Norm Vol.	Standard partial volumes	Temperature	Standard partial volume counter	Standard volume
Steam Act. Volume	Operating volumes	Temperature	Totaliser volumes	-
Steam/Water Mass	Mass	Temperature	Totaliser mass	Operating volumes
Steam/Water Energy	Energy	Temperature	Energy counter	Mass

4.9.6 Possible selection of HART® Variables depending on the respective operating mode

The following table shows the possible process variables which can be assigned to the HART variables (PV, SV, TV or Qv) depending on the operating mode. The process variables can be assigned to the HART variables via the Device Type Manager or the EDD/FDI package in the Field Information Manager (FIM tool).

Operating mode	PV		
Liquid Volume	Operating volumes	Temperature	Totaliser volumes
Liquid Std/Norm Vol.	Standard volume	Temperature	Standard volume counter
Liquid Mass	Mass	Temperature	Totaliser mass
Liquid Energy	Energy	Temperature	Energy counter
Gas Act. Volume	Operating volumes	Temperature	Totaliser volumes
Gas Std/Norm Vol.	Standard volume	Temperature	Standard volume counter
Gas Mass	Mass	Temperature	Totaliser mass
Gas Power	Energy	Temperature	Energy counter
Bio Act. Volume	Partial operating volumes	Temperature	Partial volume counter
Bio Std/Norm Vol.	Standard partial volumes	Temperature	Standard partial volume counter
Steam Act. Volume	Operating volumes	Temperature	Totaliser volumes
Steam/Water Mass	Mass	Temperature	Totaliser mass
Steam/Water Energy	Energy	Temperature	Energy counter

Additional dynamic HART variables which can be selected

-	-	-	-	-	-
Operating volumes	Totaliser volumes	-	-	-	-
Operating volumes	Totaliser volumes	-	-	-	-
Operating volumes	Totaliser volumes	Mass	Totaliser mass	-	-
-	-	-	-	-	-
Operating volumes	Totaliser volumes	-	-	-	-
Operating volumes	Totaliser volumes	-	-	-	-
Operating volumes	Totaliser volumes	Standard volumes	Standard volume counter	-	-
Operating volumes	Totaliser volumes	-	-	-	-
Operating volumes	Totaliser volumes	Standard volumes	Standard volume counter	Partial operating volumes	Partial volume counter
-	-	-	-	-	-
Operating volumes	Totaliser volumes	-	-	-	-
Operating volumes	Totaliser volumes	Mass	Totaliser mass	-	-

4.9.7 Operating modes

The parameters for the different operating modes are described in the following table.

Operating mode/ (order code)	Designation	Additional parameters required	Parameter setting
Liquid Volume/NL1	Operating volume flow (for liquid measuring medium).	-	-
	Standard volume flow (for liquid measuring medium).	Measuring medium temperature ¹	With internal temperature sensor. No information required, the measured value from the temperature sensor is used.
Liquid Volume (temperature compensated)/NL2			Default setting for the temperature value: Device Setup/Plant/Customised/ Compensation Setting -> Preset Int. Temp.
		Reference temperature in the normal condition.	Device Setup/Plant/Customised/ Compensation Setting -> Ref. Temperature.
		Volume expansion coefficient.	Device Setup/Plant/Customised/ Compensation Setting -> Volume Exp. Coef.
Liquid Mass (no adjustment)/NL3	Liquid mass flow, based on direct determination of the operating density via analog input, HART input or default setting. (for liquid measuring medium).	Operating density ^{2 3}	Via analog input: Input/Output/Field Input/Analog In Value -> Density.
			Via HART input: Input/Output/Field Input/HART In Value -> Density.
			Default setting for the density: Device Setup/Plant/Customised/ Compensation Setting -> Preset Density.

¹ The highest priority of the device is to record the operating temperature.

² The highest priority of the device is to record the density via the analog input, as long as the analog input is activated as a density input. If the analog input is not available as a density input, the system attempts to record the density via the HART input. If both the analog input and the HART input are deactivated as a density input, the system uses the default density value.

³ The connection via the analog input or HART input is described in Section 3.18 **Devices with HART communication.**

Operating modes (continued)

Operating mode/ (order code)	Designation	Additional parameters required	Parameter setting
Liquid Mass (density adjustment)/NL3	Mass flow rate, based on the density under reference conditions and density expansion coefficient in the normal condition (for liquid measuring medium).	Measuring medium temperature ¹	With internal temperature sensor. No information required, the measured value from the temperature sensor is used.
		Reference temperature in the normal condition.	Default setting for the temperature value: Device Setup/Plant/Customised/ Compensation Setting -> Preset Int.Temp.
		Density expansion coefficient.	Device Setup/Plant/Customised/ Compensation Setting -> Ref. Temperature.
		Density under reference conditions in the normal condition.	Device Setup/Plant/Customised/ Compensation Setting -> Ref. Density.
Liquid Mass (volume adjustment)/NL3	Liquid mass flow, based on density under reference conditions and volume expansion coefficient in the normal condition (for liquid measuring medium).	Measuring medium temperature ¹	With internal temperature sensor. No information required, the measured value from the temperature sensor is used.
		Reference temperature in the normal condition.	Default setting for the temperature value: Device Setup/Plant/Customised/ Compensation Setting -> Preset Int.Temp.
		Volume expansion coefficient.	Device Setup/Plant/Customised/ Compensation Setting -> Ref. Temperature.
		Density under reference conditions in the normal condition.	Device Setup/Plant/Customised/ Compensation Setting -> Ref. Density.

¹ The highest priority of the device is to record the operating temperature.

Operating modes continued on next page

Operating modes (continued)

Operating mode/ (order code)	Designation	Additional parameters required	Parameter setting
Liquid Energy/NL4⁴	Energy measurement, such as brine or condensate (for liquid measuring medium).	Heat capacity.	Device Setup/Plant/Customised/ Compensation Setting -> Specific Heat Capacity.
		Upstream measuring medium temperature ¹	With internal temperature sensor. No information required, the measured value from the temperature sensor is used. Default setting for the temperature value: Device Setup/Plant/Customised/ Compensation Setting -> Preset Int.Temp.
		Reverse measuring medium temperature ^{3 5}	Via analog input: Input/Output/Field Input/Analog In Value -> Temperature Via HART input: Input/Output/Field Input/HART In Value -> Temperature. Default setting for the temperature: Device Setup/Plant/Customised/ Compensation Setting -> Preset Ext. Tem.p

¹ The highest priority of the device is to record the operating temperature.

³ The connection via the analog input or HART input is described in Section **3.18 Devices with HART communication**.

⁴ In order to implement the 'Liquid Energy' mode, required parameters from one of the NL3 modes must be available as a precondition. Refer to Section **4.9.8 Energy measurement for liquid measuring medium (except water)**.

⁵ The highest priority of the device is to record the temperature via the analog input, as long as the analog input is activated as a temperature input. If the analog input is not available as a temperature input, the system attempts to record the temperature via the HART input. If both the analog input and the HART input are deactivated as a temperature input, the system uses the default density value.

Operating modes (continued)

Operating mode/ (order code)	Designation	Additional parameters required	Parameter setting
Steam Act. Volume/NS1	Actual volume flow rate of steam.	n/a	-
		Steam type.	Selection of steam type via: Device Setup/Plant/Customised/ Compensation Setting/Water/Steam Type.
			Via analog input: Input/Output/Field Input/Analog In Value -> Pressure.
			Via HART input: Input/Output/Field Input/HART In Value -> Pressure.
Steam/Water Mass (internal density determination)¹⁰/ NS2	Mass flow rate of steam/ hot water. The calculation is done in accordance with IAPWS-IF97.	Operating pressure ^{3 6}	Default setting for the pressure value: Device Setup/Plant/Customised/ Compensation Setting -> Preset Pressure(abs).
		Operating temperature ^{3 5}	With internal temperature sensor. No information required, the measured value from the temperature sensor is used. Default setting for the temperature value: Device Setup/Plant/Customised/ Compensation Setting -> Preset Int. Temp.

³ The connection via the analog input or HART input is described in Section **3.18 Devices with HART communication**.

⁵ The highest priority of the device is to record the temperature via the analog input, as long as the analog input is activated as a temperature input. If the analog input is not available as a temperature input, the system attempts to record the temperature via the HART input. If both the analog input and the HART input are deactivated as a temperature input, the system uses the default density value.

⁶ The highest priority of the device is to record the pressure via the analog input, as long as the analog input is activated as a pressure input. If the analog input is not available as a pressure input, the system attempts to record the pressure via the HART input. If both the analog input and the HART input are deactivated as a pressure input, the system uses the default pressure value.

¹⁰ In order to implement the 'Steam/Water Mass' mode with internal density determination, the selection 'Calculated from...' must be set in the Device Setup/Plant/Customised/Compensation Setting -> Density Selection menu.

Operating modes continued on next page

Operating modes (continued)

Operating mode/ (order code)	Designation	Additional parameters required	Parameter setting
Steam/Water Mass (external density determination)/NS2 ¹¹	Mass flow rate of steam/hot water.	Steam type.	Selection of steam type via: Device Setup/Plant/Customised/ Compensation Setting/Water/Steam Type.
		Operating density ^{2 3}	Via analog input: Input/Output/Field Input/Analog In Value -> Density.
			Via HART input: Input/Output/Field Input/HART In Value -> Density.
			Default setting for the density: Device Setup/Plant/Customised/ Compensation Setting -> Preset Density.
Steam/Water Energy/NS3 ¹²	Energy flow of steam/ hot water. The calculation is done in accordance with IAPWS-IF97. ¹³	Steam type.	Selection of steam type via: Device Setup/Plant/Customised/ Compensation Setting/Water/Steam Type.
		Energy calculation.	Selection of the type of energy calculation via: Device Setup/Plant/Customised/ Compensation Setting Energy calc. method.
		Upstream measuring medium temperature ¹⁴	With internal temperature sensor. No information required, the measured value from the temperature sensor is used. Default setting for the temperature value: Device Setup/Plant/Customised/ Compensation Setting -> Preset Int.Temp.

² The highest priority of the device is to record the density via the analog input, as long as the analog input is activated as a density input. If the analog input is not available as a density input, the system attempts to record the density via the HART input. If both the analog input and the HART input are deactivated as a density input, the system uses the default density value.

³ The connection via the analog input or HART input is described in Section **3.18 Devices with HART communication**.

¹¹ In order to implement the 'Steam/Water Mass' mode with external density determination, in the Device Setup/Plant/Customised/Compensation Setting -> Density Selection menu, the selection 'Ext. Density' must be made.

¹² For a detailed description of steam calculation, refer to Section **4.9.10 Energy measurement for steam/hot water in accordance with IAPWS-IF97**.

¹³ Two different properties of steam are supported: saturated steam and overheated steam. The end user can change this in the Device Setup/Plant/Customised/Compensation Setting -> Water/Steam Type menu item.

¹⁴ Required only for net energy calculation of the actually consumed energy.

Operating modes (continued)

Operating mode/ (order code)	Designation	Additional parameters required	Parameter setting
Steam/Water Energy/NS3 ¹² (continued)	Energy flow of steam/ hot water. The calculation is done in accordance with IAPWS-IF97. ¹³	Reverse measuring medium temperature ¹⁴	Via analog input: Input/Output/Field Input/Analog In Value -> Temperature.
			Via HART input: Input/Output/Field Input/HART In Value -> Temperature.
			Default setting for the temperature: Device Setup/Plant/Customised/Compensation Setting -> Preset Ext.Temp.
		Operating pressure ³⁶	Via analog input: Input/Output/Field Input/Analog In Value -> Pressure.
			Via HART input: Input/Output/Field Input/HART In Value -> Pressure.
			Default setting for the pressure value: Device Setup/Plant/Customised/Compensation Setting -> Preset Pressure(abs).
Operating temperature ³⁵	With internal temperature sensor. No information required, the measured value from the temperature sensor is used.		
	Default setting for the temperature value: Device Setup/Plant/Customised/ Compensation Setting -> Preset Int.Temp.		

³ The connection via the analog input or HART input is described in Section **3.18 Devices with HART communication**.

⁵ The highest priority of the device is to record the temperature via the analog input, as long as the analog input is activated as a temperature input. If the analog input is not available as a temperature input, the system attempts to record the temperature via the HART input. If both the analog input and the HART input are deactivated as a temperature input, the system uses the default density value.

⁶ The highest priority of the device is to record the pressure via the analog input, as long as the analog input is activated as a pressure input. If the analog input is not available as a pressure input, the system attempts to record the pressure via the HART input. If both the analog input and the HART input are deactivated as a pressure input, the system uses the default pressure value.

¹² For a detailed description of steam calculation, refer to Section **4.9.10 Energy measurement for steam/hot water in accordance with IAPWS-IF97**.

¹³ Two different properties of steam are supported: saturated steam and overheated steam. The end user can change this in the Device Setup/Plant/Customised/Compensation Setting -> Water/Steam Type menu item.

¹⁴ Required only for net energy calculation of the actually consumed energy.

4.9.8 Energy measurement for liquids, gases and steam

Note: Pulse output for energy measurement:

- The pulse output generally relates to the selected flow unit.
- If the flow unit is selected as energy unit 'watt (W), kilowatt (KW), or megawatt (MW)', the pulses relate to J (W), KJ (KW), or MJ (MW). 1 watt then corresponds to 1 J/s.

4.9.9 Energy measurement for liquid measuring medium (except water)

Order code N1 - Only available with Modbus communications

For liquid measuring medium (except water)

The VLM30 has an extended function for measuring the energy flow for fluids, which is built into the transmitter. Based on the values for actual volume flow, density, heat capacity of the medium (energy unit/mass flow unit), temperature of the feed flow (built-in Pt100 resistance thermometer) and temperature of the return flow, the transmitter calculates the actual volume flow and the energy flow.

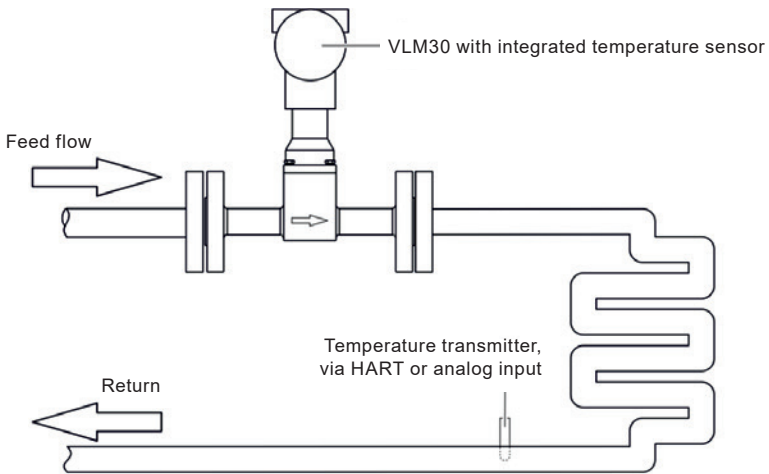

Fig. 37 Measuring the energy of liquids

For steam/hot water in accordance with IAPWS-IF97

The VLM30 with option N1 has an extended function for measuring the flow of steam, which is built into the transmitter.

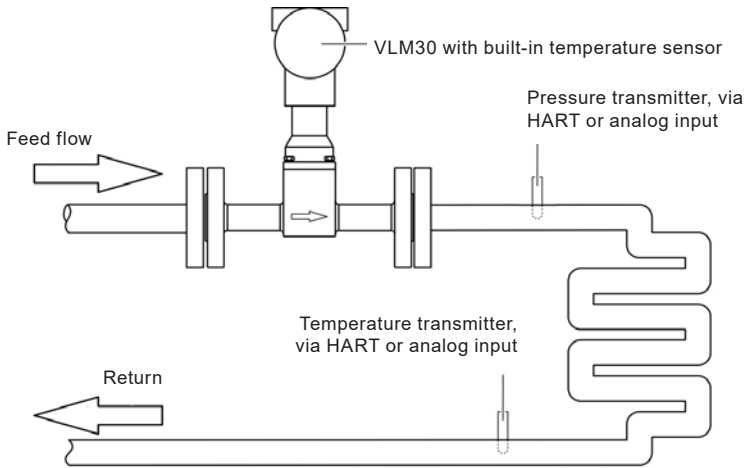

Fig. 38 Energy measurement

Based on the values of pressure (external diaphragm seal, connected via HART or analog input, or a preset pressure value) and temperature (built-in Pt100 resistance thermometer), the transmitter calculates the density and the energy content of the measuring medium. The measured volume flow rate is converted into the mass flow rate and energy flow rate.

The type of energy calculation can be selected:

- Gross energy: The amount of energy that flows through the device is recorded. Any energy re-flow in form of condensate is not considered.
- Net energy: The amount of energy that flows through the device is recorded. Any energy re-flow in form of condensate is deducted again from the amount of energy. For this, an additional external temperature transmitter must be connected.

For energy measurement, the medium types 'Saturated Steam', 'Overheated Steam' or 'Hot Water' can be selected. The calculation is done according to IAPWS-IF97.

Calculation of the net energy for steam

$$Q_p = Q_m \times (H_{\text{steam}} - H_{\text{water}})$$

Calculation of the net energy for hot water/condensate

$$Q_p = Q_m \times (H_{\text{water_in}} - H_{\text{water_out}})$$

Formula elements used

Q_p	Net energy
Q_m	Mass flow
H_{steam}	Steam enthalpy
H_{water}	Water enthalpy
$H_{\text{water_in}}$	Water enthalpy (feed flow)
$H_{\text{water_out}}$	Water enthalpy (return flow)

Prerequisites for the energy measurement:

- When measuring the energy of steam, the steam must condense completely.
- The process must form a closed system, energy losses due to leaks are not recorded.

Steam mass calculation

The following options are available for the steam mass calculation:

- Density calculated from the temperature (saturated steam only).
- Density calculated from the pressure (saturated steam only).
- Density calculated from pressure and temperature.
- Constant density.

If a pressure transmitter is connected, the steam state is checked automatically. A distinction is made between wet steam, saturated steam, and superheated steam. The correct density is always calculated regardless of the selected media type.

If a pressure transmitter is not connected and steam type 'Overheated Steam' is selected, a constant pressure must be entered for the state to be detected and, if applicable, the density to be calculated.

A value must always be stored for the steam density value (constant) in the transmitter in order to define the measuring range limits for Q_{max} DN in mass flow units. An approximation is sufficient here, the density diagrams provide an indication for determining the steam density.

4.9.10 Density diagrams

The following diagrams show an extract from the density table for saturated steam at different temperatures/ pressures.

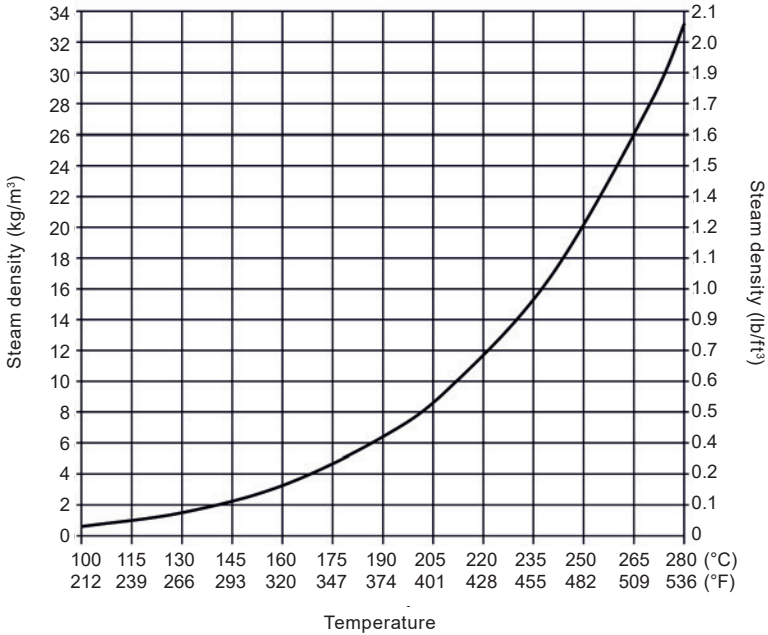

Fig. 39 Saturated steam pressure by temperature

Density diagrams continued on next page

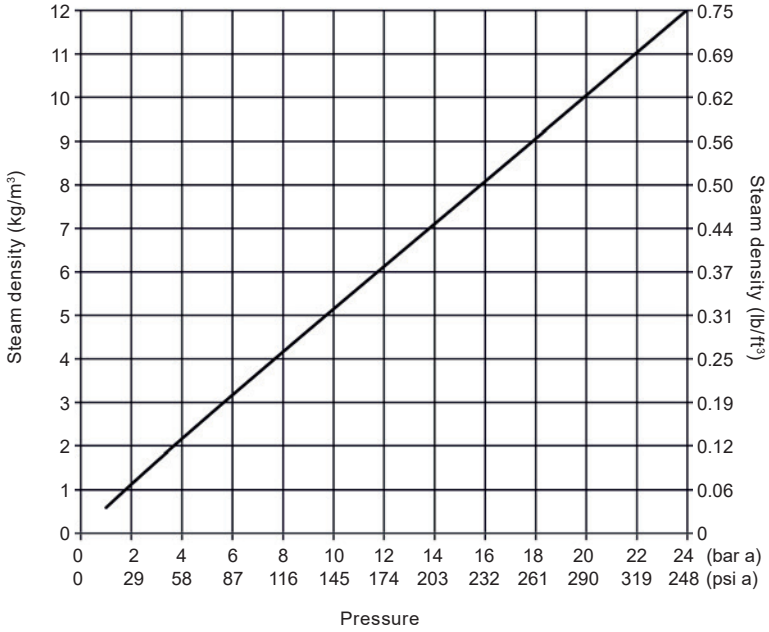
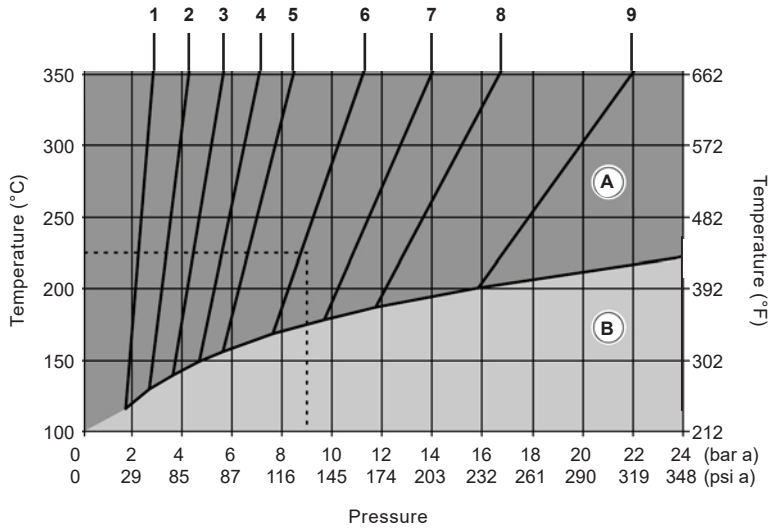

Fig. 40 Saturated steam density by pressure



- | | | | |
|----|--|---|----------------------|
| 1 | 1.0 kg/m ³ (0.06 lb/ft ³) | A | Hot steam zone |
| 2 | 1.5 kg/m ³ (0.09 lb/ft ³) | B | Saturated steam zone |
| 3 | 2 kg/m ³ (0.12 lb/ft ³) | | |
| 4 | 2.5 kg/m ³ (0.16 lb/ft ³) | | |
| 5 | 3 kg/m ³ (0.19 lb/ft ³) | | |
| 6 | 4 kg/m ³ (0.25 lb/ft ³) | | |
| 7 | 5 kg/m ³ (0.31 lb/ft ³) | | |
| 8 | 6 kg/m ³ (0.37 lb/ft ³) | | |
| 9 | 8 kg/m ³ (0.50 lb/ft ³) | | |
| 10 | Saturated steam limit | | |

The parallel lines 1 to 9 are lines of the same density.

Fig. 41 Steam density for hot steam

Application example (broken line in diagram)

Superheated steam with 225°C, 9 bar abs (437 °F, 130 psi a).
It yields a steam density of approx. 4.1 kg/m³ (0.26 lb/ft³).

4.9.11 Calculation of the density

The density calculation method is selected using the 'Density Selection' parameter.

Media type	Calculation method	Description
Saturated Steam		The steam density is calculated in accordance with the saturated steam curve using the measured temperature value from the internal temperature sensor.
	Calc. From T	If using a VLM30 without optional internal temperature sensor, a constant (parameter 'Preset Int.Temp') must be entered for the temperature. Alternatively, an external temperature transmitter can also be connected with HART communication.
		The steam density is calculated according to IAPWS-IF97 with a measured pressure value.
	Calc. From P	The measured pressure value can either be supplied via the analog input, the HART input, or as a constant (parameter 'Preset Pressure(abs)').
		The steam density is calculated in accordance with IAPWS-IF97 using the measured temperature value from the internal temperature sensor and a measured pressure value.
		The measured pressure value can either be supplied via the analog input, the HART input, or as a constant (parameter 'Preset Pressure(abs)').
	Calc. From P&T	If using a VLM30 without optional internal temperature sensor, a constant (parameter 'Preset Int.Temp') must be entered for the temperature. Alternatively, an external temperature transmitter can also be connected with HART communication.
		If the steam is not saturated steam, the device issues a warning 'Wrong Steam Type'. The density and energy content of the steam is then calculated as overheated steam using the current values.
		If the steam temperature is too low (wet steam), the device issues a warning 'Wrong Steam Type'. The density (and energy if necessary) is then calculated in accordance with the saturated steam curve based on the measured value of the internal or external temperature sensor.
		If the 'Wrong Steam Type' warning is set, a status message with the steam status is additionally generated, while the time of the active status message is incremented and can be assessed.
	Ext. Density	The steam mass is calculated using the density value that is supplied either via the analog input, the HART input, or as a constant (parameter 'Preset Density'). Detection of wet steam/overheated steam is not possible with this calculation method.

Media type	Calculation method	Description
Overheated Steam		<p>The steam density is calculated in accordance with IAPWS-IF97 using the measured temperature value from the internal temperature sensor and a measured pressure value.</p> <p>The measured pressure value can either be supplied via the analog input, the HART input, or as a constant (parameter 'Preset Pressure(abs)').</p>
	Calc. From P&T	<p>If using a VLM30 without optional internal temperature sensor, a constant (parameter 'Preset Int.Temp') must be entered for the temperature. Alternatively, an external temperature transmitter can also be connected with HART communication.</p>
		<p>If the steam temperature is too low (wet steam), the device issues a warning 'Wrong Steam Type'. The density (and energy if necessary) is then calculated in accordance with the saturated steam curve based on the measured value of the internal or external temperature sensor.</p> <p>If the 'Wrong Steam Type' warning is set, a status message with the steam status is additionally generated, while the time of the active status message is incremented and can be assessed.</p>
	Ext. Density	<p>The steam mass is calculated using the density value that is supplied either via the analog input, the HART input, or as a constant (parameter 'Preset Density ').</p> <p>Detection of wet steam/overheated steam is not possible with this calculation method.</p>
Hot Water		<p>The density is calculated in accordance with IAPWS-IF97 using the measured temperature value from the internal temperature sensor.</p>
	Calc. From T	<p>If using a VLM30 without optional internal temperature sensor, a constant (parameter 'Preset Int.Temp') must be entered for the temperature. Alternatively, an external temperature transmitter can also be connected with HART communication.</p>
	Ext. Density	<p>The hot water mass is calculated from the density.</p> <p>The density can either be supplied via the analog input, the HART input, or as a constant (parameter 'Preset Density ').</p>

Note: Regardless of the media type and the calculation method, a density value must be entered in the 'Device Setup/Plant/Customised/Compensation Setting/Preset Density ' menu to determine the max. measuring range limits.

- The entered density will not be used for compensation purposes.
- The entered density should be calculated in accordance with the typical (maximum) operating conditions.

5. Operation

5.1 Safety instructions

	<p>Caution! Risk of burns due to hot measuring media The device surface temperature may exceed 70 °C (158 °F), depending on the measuring medium temperature!</p> <ul style="list-style-type: none">- Before starting work on the device, make sure that it has cooled sufficiently.
---	--

If there is a chance that safe operation is no longer possible, take the device out of operation and secure it against unintended startup.

5.2 Account and password

The product supports two access accounts, one is Spirax Sarco service account, the other is standard account.

- Spirax Sarco service account.

This account can be disabled in standard account.

- Standard account.

For security reasons it is recommended, to set a password. When changing a password, record it somewhere secure. If a password is lost or unknown, it must be reset to the factory or format NV, then it will change to default status.

5.3 Parameterisation of the device

The LCD indicator has capacitive operating buttons. These enable you to control the device through the closed housing cover.

Note: The transmitter automatically calibrates the capacitive buttons on a regular basis. If the cover is opened during operation, the sensitivity of the buttons is firstly increased to enable operating errors to occur. The button sensitivity will return to normal during the next automatic calibration.

5.4 Menu navigation

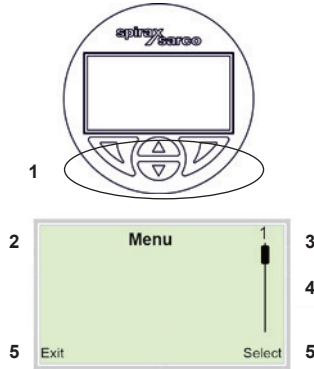







- 1 Operating buttons for menu navigation
- 2 Indication of menu designation
- 3 Indication of menu number
- 4 Marking to indicate relative position within the menu
- 5 Indication of the current function assigned to the operating buttons  and 

Fig. 42 LCD indicator (example)

You can use the  or  operating buttons to browse through the menu or select a number or character within a parameter value.

Different functions can be assigned to the  and  operating buttons. The function that is currently assigned is shown on the LCD display.

Operating button functions

	Meaning
Exit	Exit menu.
Back	Go back one submenu.
Cancel	Cancel parameter entry.
Next	Select the next position for entering numerical and alphanumeric values.
	Meaning
Select	Select submenu/parameter.
Edit	Edit parameter.
OK	Save parameter entered.

5.5 Menu levels

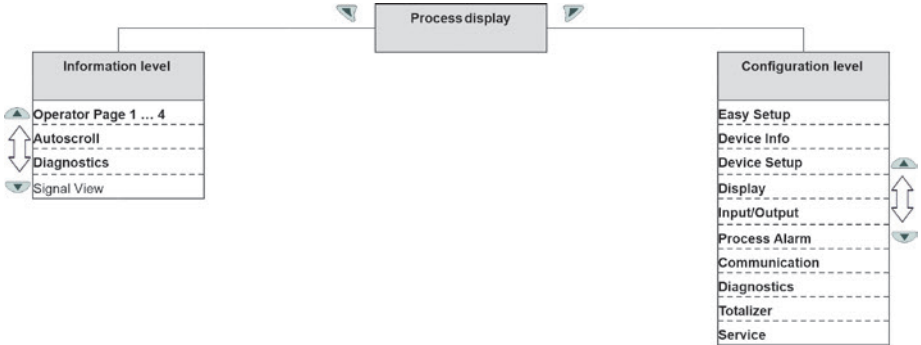

Process display

The process display shows the current process values. There are two menu levels under the process display.

Information level (Operator Menu)

The information level contains the parameters and information that are relevant for the operator. The device configuration cannot be changed on this level.

Configuration level (Configuration)

The configuration level contains all the parameters required for device commissioning and configuration. The device configuration can be changed on this level. For detailed information on the parameters, refer to Section **5.10 Parameter descriptions**.

Note: With the hardware write protection activated (see Section **4.9.3 DIP switch on the HART® communication board** or Section **4.9.5 DIP switch on the Modbus communication board**), the device configuration can no longer be changed using the LCD indicator or the Fieldbus interface. By activating the hardware write protection and sealing the respective DIP switches, the device can be protected against unauthorised changes to the device configuration.

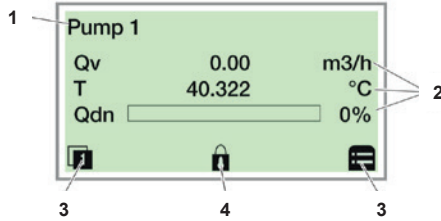

5.6 Process display







- 1 Measuring point tagging
- 2 Current process values
- 3 'Button function' symbol
- 4 'Parameterisation protected' symbol

Fig. 43 Process display (example)

The process display appears on the LCD display when the device is powered on. It shows information about the device and current process values.

The way in which the current process values are shown can be adjusted on the configuration level. The symbols at the bottom of the process display are used to indicate the functions of the operating buttons  and  , in addition to other information.

Symbol	Description
 	Call up information level. When Autoscroll mode is activated, the icon appears here and the operator pages are automatically displayed one after the other.
	Call up configuration level.
	The device is protected against changes in the parametrization.

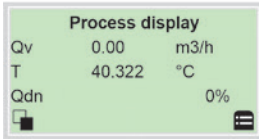

Switching to the information level (operator menu)

On the information level, the operator menu can be used to display diagnostic information and choose which operator pages to display.

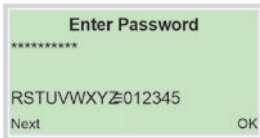

1. Open the  using Operator Menu.



2. Use  /  'Standard' to make the selection.

3. Confirm the selection with .

Menu	Description
.../Operator Menu	
Diagnostics	Selection of sub-menu 'Diagnostics'; see also Section 5.8 Error messages on the LCD display .
Operator Page 1 to n	Selection of operator page to be displayed.
Autoscroll	When 'Autoscroll' is activated, automatic switching of the operator pages is initiated on the process screen.
Signal view	Selection of submenu 'Signal view' (only for service purposes).



5.7 Switching to the configuration level (parameterisation)

The device parameters can be displayed and changed on the configuration level.

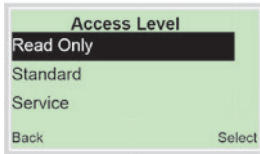

1. Switch to the configuration level with .



2. Select the desired level of access using  .
3. Confirm the selection with .

Note: There are three levels of access. A password can be defined for level 'Standard'. There is no factory default password. For security reasons it is recommended, to set a password.

Access Level	Description
Read Only	All parameters are locked. Parameters are read only and cannot be modified.
Standard	All the parameters can be altered.
Service	Only Customer Service has access to the Service menu.

Once you have logged on to the corresponding access level, you can edit or reset the password. Reset (status 'no password defined') by selecting '' as a password.

The newly assigned password is not valid until you log out from the 'Standard'.

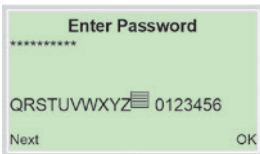



4. Enter the corresponding password (see Section **5.7 Selecting and changing parameters**). No password is preset in the factory settings. Users can switch to the configuration level without entering a password.

The selected access level remains active for 3 minutes. Within this time period you can toggle between the process display and the configuration level without re-entering the password.

5. Use .

The LCD display now indicates the first menu item on the configuration level.

6. Select a menu using  .
7. Confirm the selection with .

5.8 Selecting and changing parameters

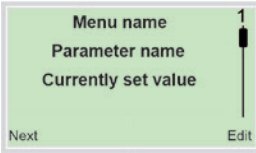

Entry from table

When an entry is made from a table, a value is selected from a list of parameter values.

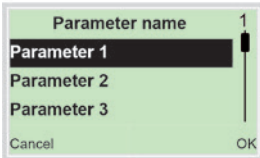

1. Select the parameters you want to set in the menu.
2. Use  to call up the list of available parameter values. The parameter value that is currently set is highlighted.





3. Select the desired value using .
4. Confirm the selection with .

This concludes the procedure for selecting a parameter value.



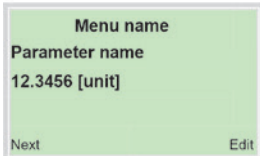

Numerical entry

When a numerical entry is made, a value is set by entering the individual decimal positions.

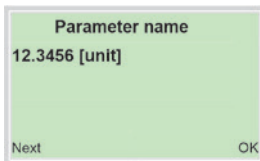

1. Select the parameters you want to set in the menu.
2. Use  to call up the parameter for editing. The decimal place that is currently selected is highlighted.





3. Use  to select the decimal place to change.
4. Use  to set the desired value.
5. Use  to select the next decimal place.
6. If necessary select and set additional decimal places in accordance with steps 3 to 4.
7. Use  to confirm your setting.

This concludes the procedure for changing a parameter value.



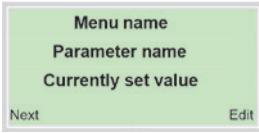

Alphanumeric entry

When an alphanumeric entry is made, a value is set by entering the individual decimal positions.

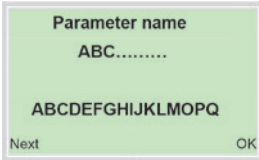

1. Select the parameters you want to set in the menu.
2. Use  to call up the parameter for editing. The decimal place that is currently selected is highlighted.



3. Use  to select the decimal place to change.
4. Use  /  to set the desired value.
5. Use  to select the next decimal place.
6. If necessary select and set additional decimal places in accordance with steps 3 to 4.
7. Use  to confirm your setting.

This concludes the procedure for changing a parameter value.



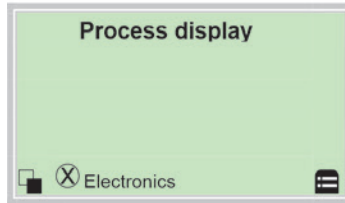

5.9 Error messages on the LCD display

In the event of an error, a message consisting of a symbol and text (e.g. Electronics) appears at the bottom of the process screen.

The text displayed provides information about the area in which the error has occurred.



The error messages are divided into four groups in accordance with the NAMUR classification scheme. The group assignment can only be changed using a DTM or EDD:

Symbol	Description
	Error/failure
	Function check.
	Outside of the specification.
	Maintenance required.

The error messages are also divided into the following areas:

Range	Description
Operation	Error/alarm due to the current operating conditions.
Sensor	Error/alarm of the flowmeter sensor.
Electronics	Error/alarm of the electronics.
Configuration	Error/alarm due to device configuration.

Note: For a detailed description of errors and troubleshooting instructions, please see Section 7 **Diagnosis/ error messages**.

5.10 Parameter overview

Note: This overview of parameters shows all the menus and parameters available on the device. Depending on the version and configuration of the device, not all of the menus and parameters may be visible in it. The various operating modes have different menu displays. In this overview, menus are marked with numbers that appear only in certain operating modes.

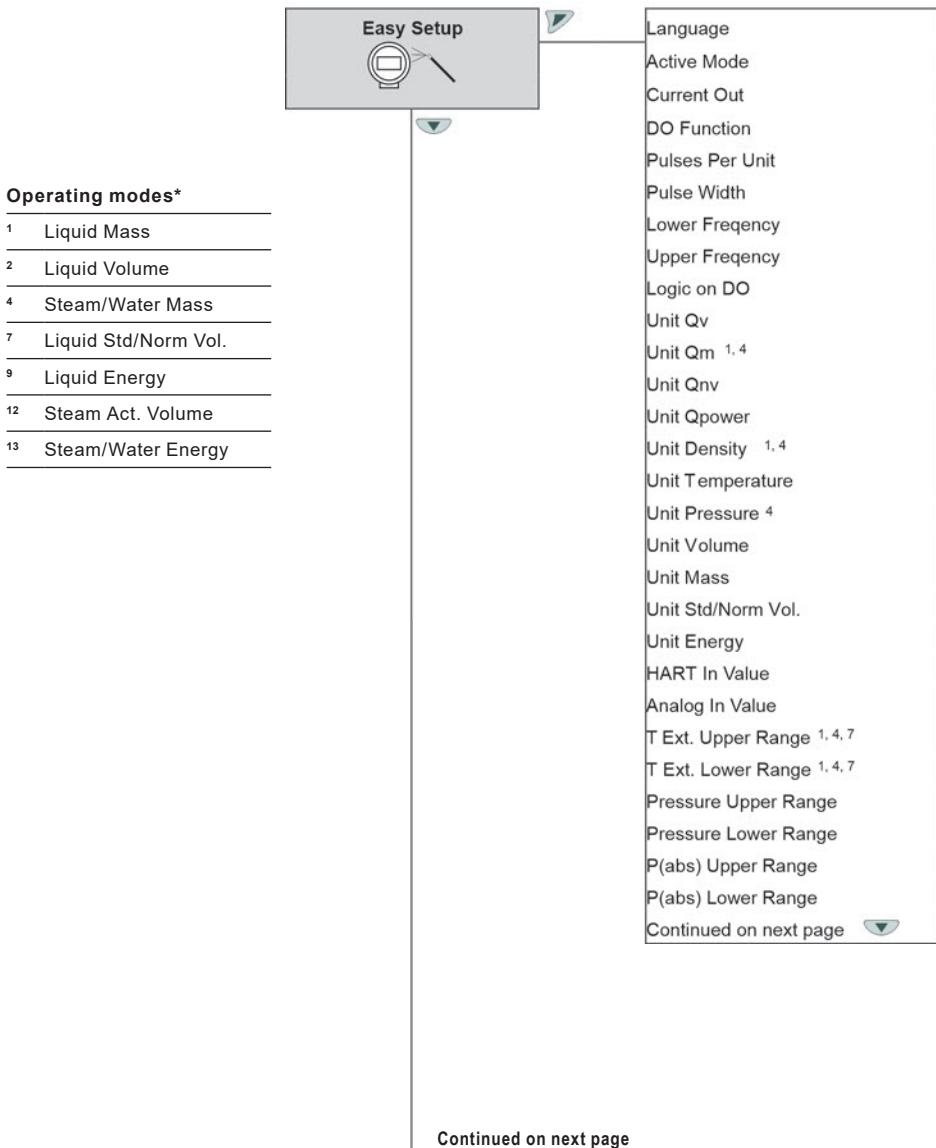

Continued from previous page

Continued
Density Upper Range
Density Lower Range
Ext.Cutoff Trigger
Liquid Mass Corr.
Volume Exp.Coeff. 1,7
Density Exp.Coeff. 1,7
Specific Heat Capacity
Water/Steam Type 4
Density Selection
Energy calc. method
Ref. Density 1
Preset Density 1,4
Ref. Temperature 1,7
Preset Int.Temp 1,4,7
Preset Ext.Temp
Preset Pressure(abs)</v> 4
Qvmax
QnMax 7
QmMax 4
QpowerMax
Damping Qv
Damping Qn 1,7
Damping Qm 4
Damping Qpower
Temp ->I=0%
Damping Temperature
Iout at Alarm
Low Alarm Value
High Alarm Value
Auto Zero
Low Flow Cutoff

Continued on next page

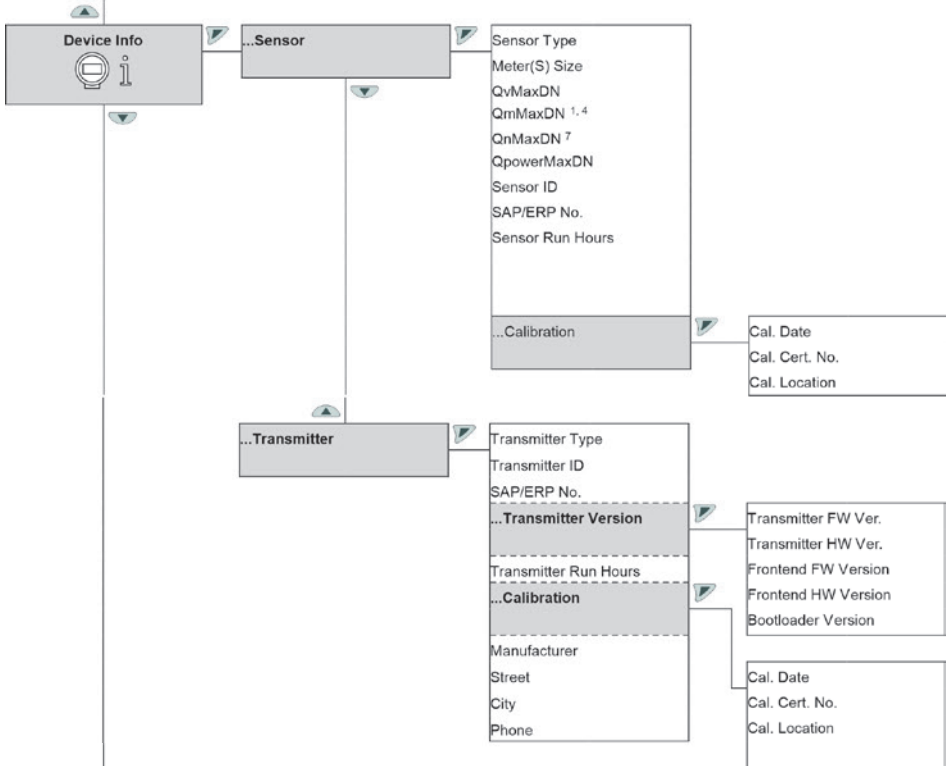

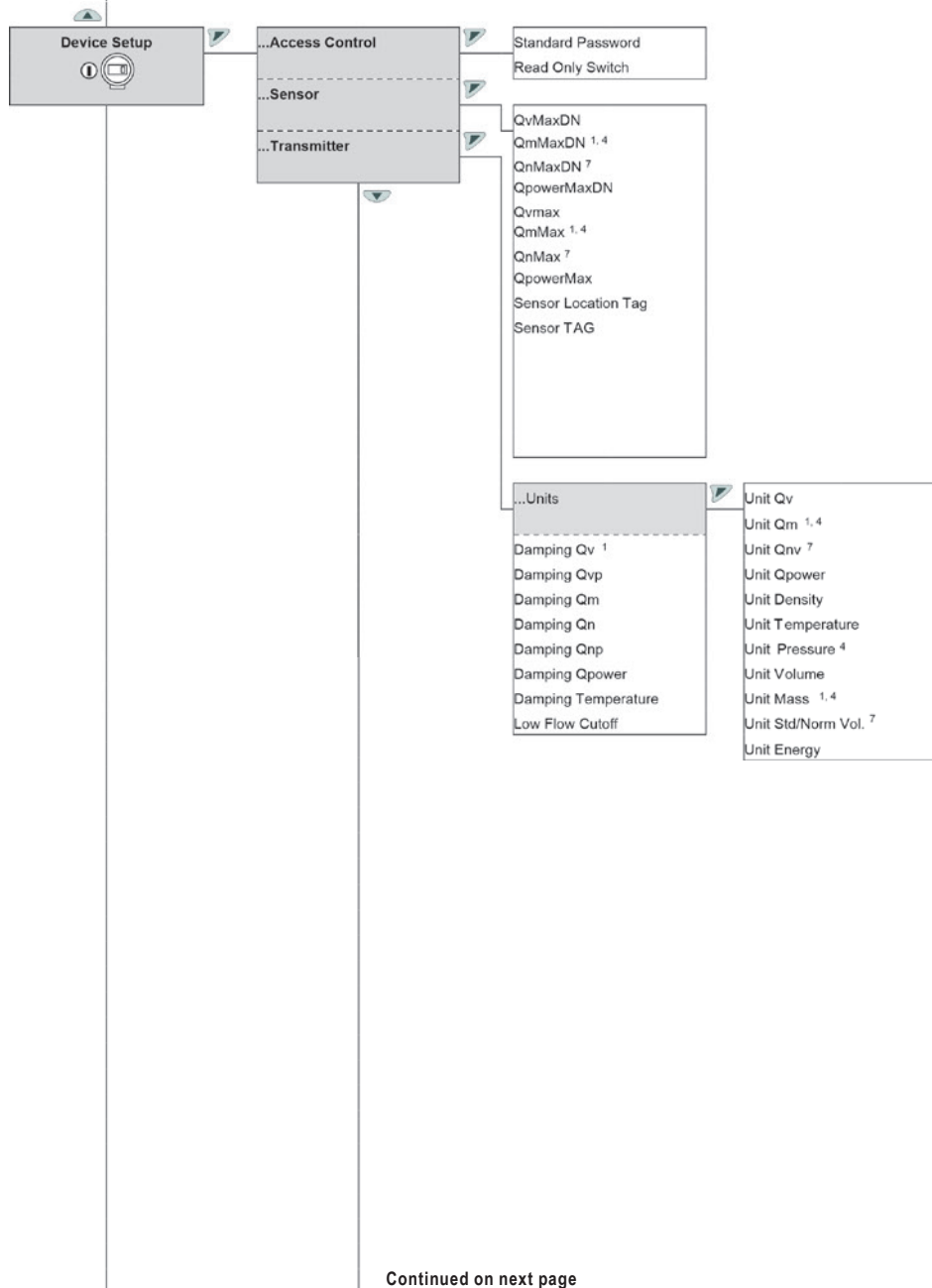

Continued on next page

Continued from previous page

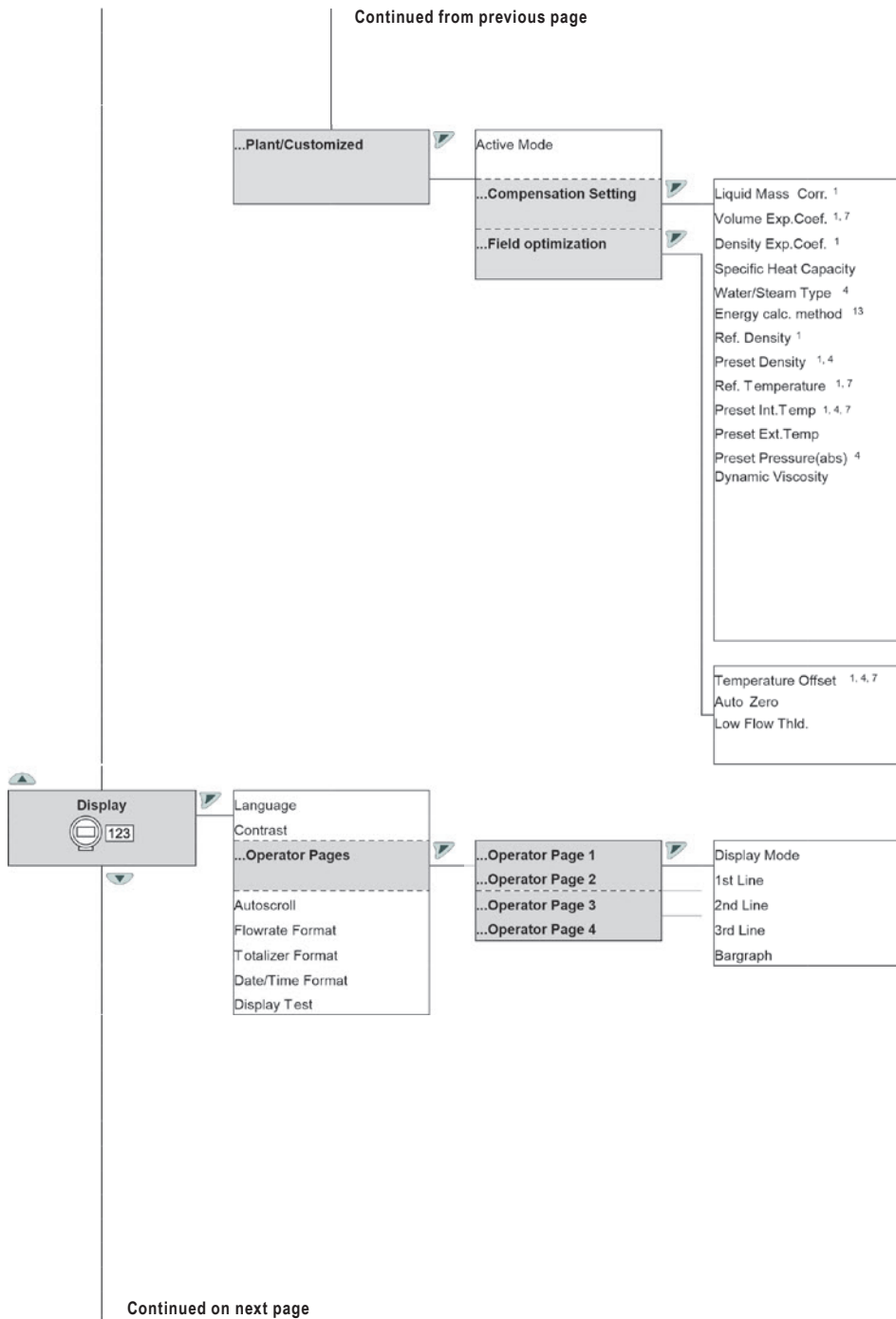

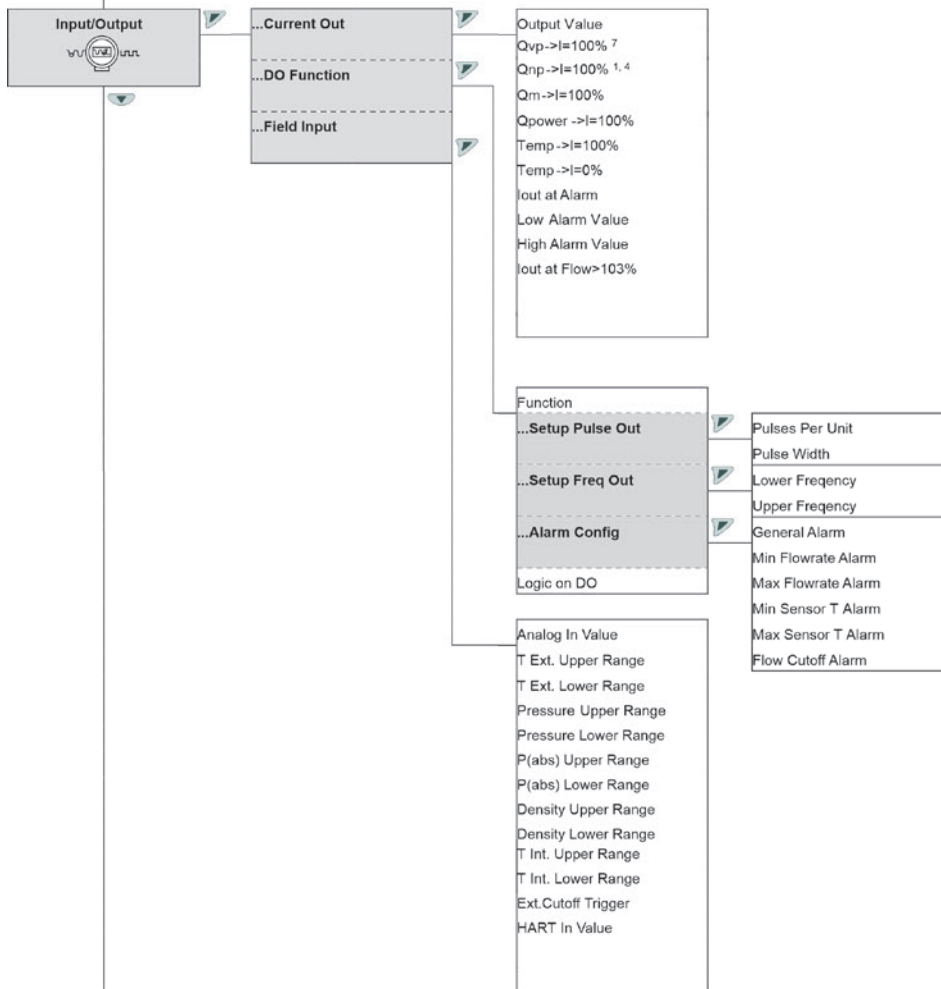

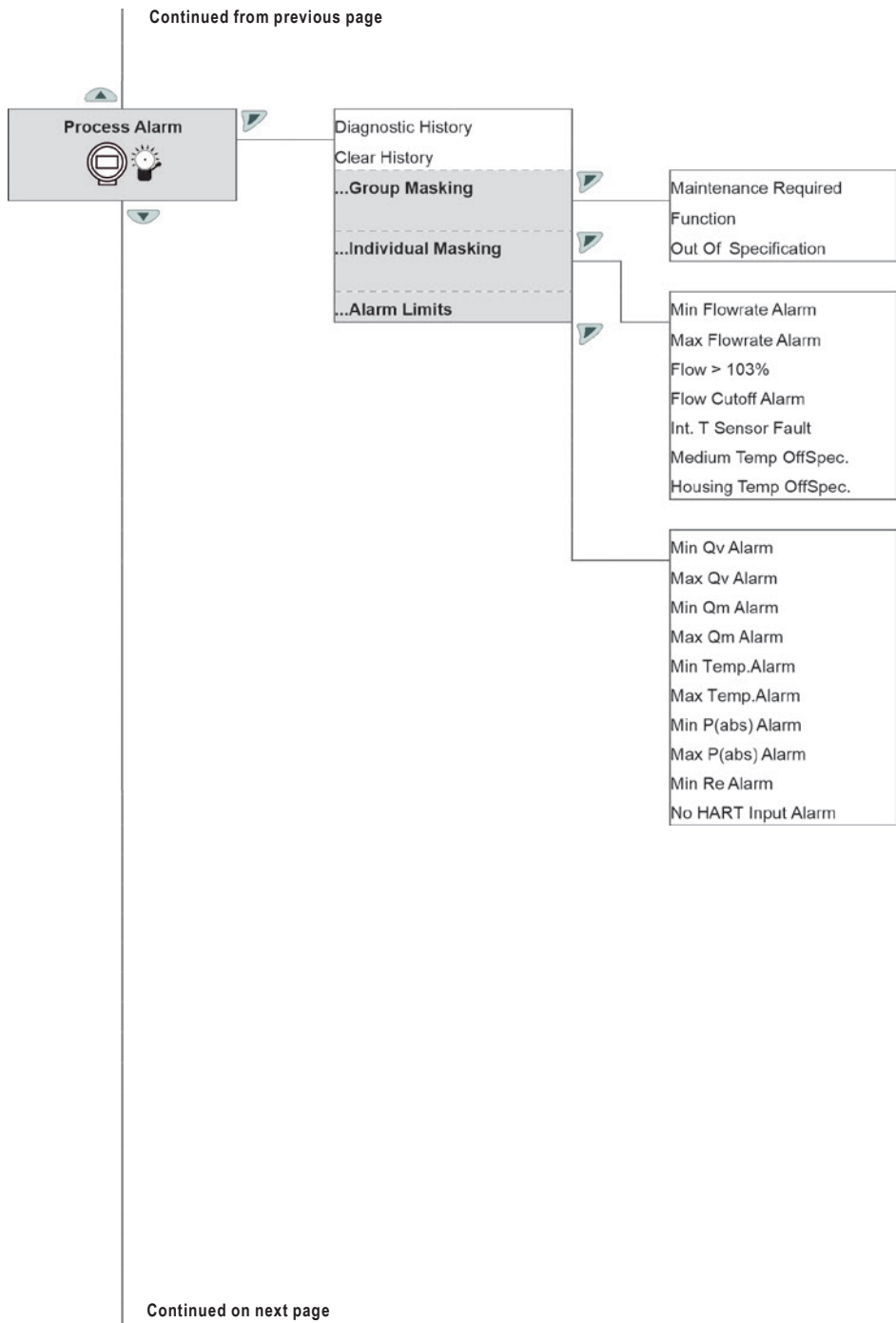

Note: The menu Communication depends on the device design.

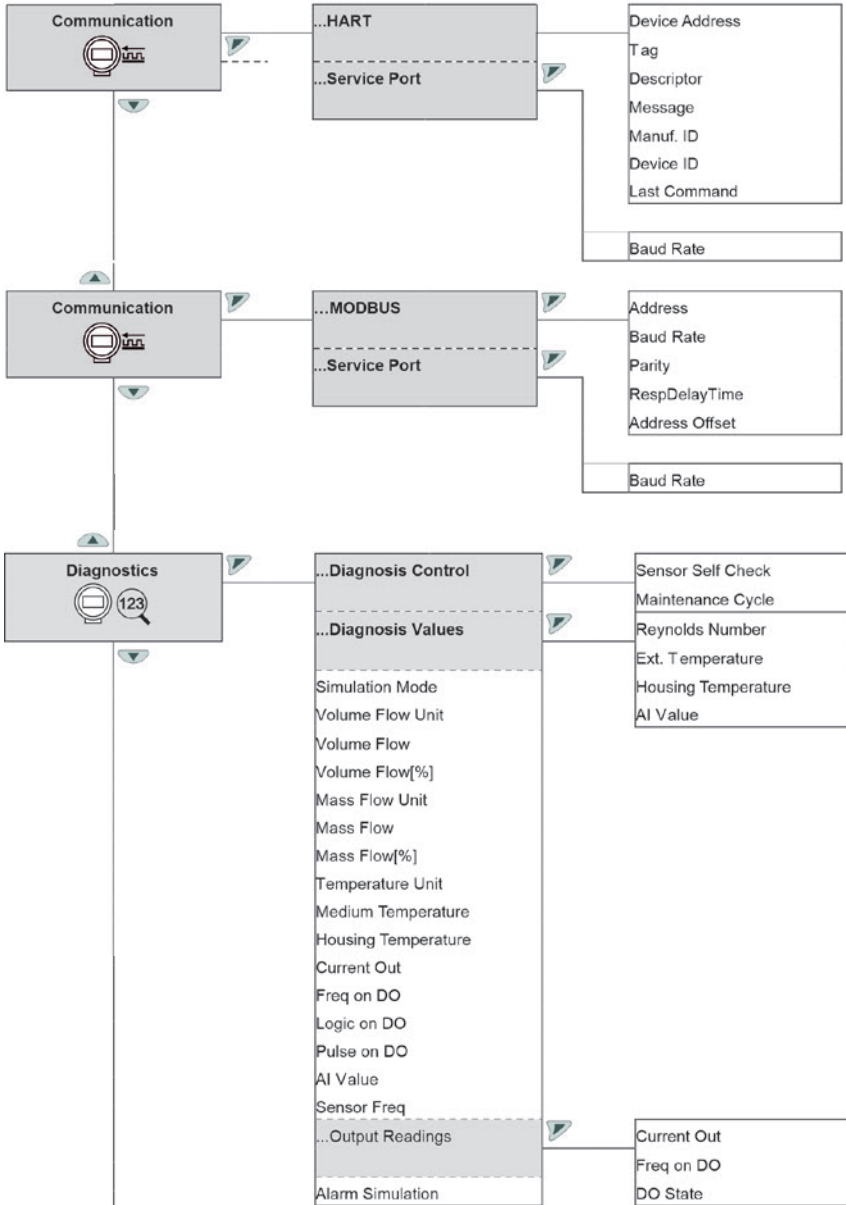

Continued on next page

Continued from previous page

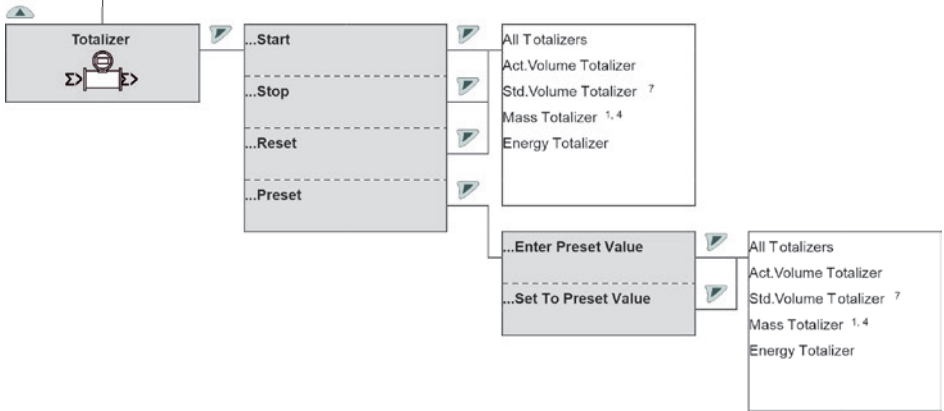

5.11 Parameter descriptions

Note

This overview of parameters shows all the menus and parameters available on the device. Depending on the version and configuration of the device, not all of the menus and parameters may be visible in it.

5.11.1 Menu: Easy Setup

Menu/parameter	Description
Easy Setup	
Language	Selection of menu language.
Active Mode	Selection of operating mode (only for devices with HART® or Modbus® communication). See Section 4.9.8 Operating modes for further information.
Output Value	Selection of the process variable issued at the current output. <ul style="list-style-type: none"> - Q: Flow - T: Temperature
DO Function	Selection of the function for the digital output.. <ul style="list-style-type: none"> - None: Digital output deactivated. - Logic on DO: Digital output as a binary output (e.g. as an alarm output). - Pulse on DO: Digital output DO1 as a pulse output. In pulse mode, pulses are output per unit (e.g. 1 pulse per m³). - Freq on DO: Digital output DO1 as a frequency output. In frequency mode, a frequency is issued that is proportional to the flow rate. The maximum frequency can be configured in accordance with the upper range value.
Pulses Per Unit	Setting of the pulses per unit of the selected operating mode and pulse width for the 'Pulse on DO' function of the digital output.
Pulse Width	Available only if the digital output has been configured as a pulse output.
Lower Frequency	Setting of the frequency range for the 'Freq on DO' function of the digital output.
Upper Frequency	Available only if the digital output has been configured as a frequency output.
Logic on DO	Select switching properties for the binary output. <ul style="list-style-type: none"> - Normally Closed: Binary output to open a normally closed contact. - Normally Open: Binary output to close a normally open contact.
Unit Q_v	Selection of unit for volume flow. m³/s, m³/min, m³/h, m³/Tag, ft³/s, ft³/min, ft³/h, ft³/Tag, l/s, l/min, l/h, l/Tag, kl/s, kl/min, kl/h, kl/Tag, us gal/s, usgal/min, us gal/h, us gal/Tag, imperial gal/s, imperial gal/min, imperial gal/h, imperial gal/day, barrel/s, barrels/min, barrel/h, barrels/day Factory setting: l/min
Unit Q_m	Selection of unit for mass flow. g/s, g/min, g/h, kg/s, kg/min, kg/h, kg/day, lbs/s, lbs/min, lbs/h, lbs/d, uton/min, uton/h, uton/day, kl/s, kl/min, kl/h, kl/day

Menu/parameter	Description
Easy Setup	
Unit Q_{nv}	Selection of unit for the standard volume flow. m ³ /s, m ³ /min, m ³ /h, m ³ /Tag, ft ³ /s, ft ³ /min, ft ³ /h, ft ³ /Tag, l/s, l/min, l/h, l/Tag, kl/s, kl/min, kl/h, kl/Tag, us gal/s, usgal/min, us gal/h, us gal/Tag, imperial gal/s, imperial gal/min, imperial gal/h, imperial gal/day, barrel/s, barrel/min, barrel/h, barrel/day, kft ³ /s, kft ³ /min, kft ³ /h, kft ³ /day, hl/s, hl/min, hl/h, hl/day, kl/s, kl/min, kl/h, kl/day Factory setting: l/min
Unit Q_{power}	Selection of unit for energy measurement. W, MW, KW, KJ/s, KJ/min, KJ/h, KJ/day, MJ/h
Unit Density	Selection of unit for density. kg/m ³ , g/cm ³ , kg/l, g/ml, g/l, lb/in ³ , lb/ft ³
Unit Temperature	Selection of unit for temperature. kelvin, celsius, fahrenheit
Unit Pressure	Selection of unit for pressure measurement. Pa, MPa, KPa, HPa, bar, mbar, mm H2O, psi, kg/cm ³
Unit Volume	Selection of unit for the volume totaliser. m ³ , ft ³ , l, milli l, hecto l, imp gallon, us gallon, us barrels beer
Unit Mass	Selection of unit for the mass counter. g, kg, t, us ton, uk ton, pounds, unze
Unit Std/Norm Vol.	Selection of unit for the standard volume totaliser. m ³ , ft ³ , l, milli l, hecto l, imp gallon, us gallon, us barrels beer
Unit Energy	Selection of unit for the energy counter. J, KJ, MJ, KWH
	Selection of the process variables measured via the HART input (only for devices with HART communication). <ul style="list-style-type: none"> - None: No remote transmitter at the input. - Temperature: Remote temperature transmitter at the input (transmitter in the reverse flow of a heating or cooling cycle for net energy calculation or transmitter in the device outlet (see Section 3.4 Installation for external pressure and temperature measurement) for temperature compensation, if no internal temperature measurement is possible/desired). - Pressure: Remote pressure transmitter at the input. - Pressure(abs): Remote absolute pressure transmitter at the input. - Gas Content: Remote gas analyser at the input. - Density: Remote transmitter at the input. - Int.T: External temperature transmitter, e.g. for using a remote temperature transmitter instead of the internal temperature sensor to increase the accuracy or reduce the response time. Refer to Section 4.9.2 HART Input.
Analog In Value	Selection of the process variables measured via the analog input (only for devices with HART communication). For description, see parameter "HART In Value". Refer to Section 3.18.6 Analog input 4 to 20 mA.

Menu/parameter	Description
Easy Setup	
T Ext. Upper Range	
T Ext. Lower Range	
Pressure Upper Range	
Pressure Lower Range	Setting of the measuring range limits for the external transmitter at the analog input.
P(abs) Upper Range	The upper value applies for a current of 20 mA at the analog input, the lower value for a current of 4 mA.
P(abs) Lower Range	The availability of this parameter depends on the process variable selected for the analog input.
Density Upper Range	
Density Lower Range	
Gas% Upper Range	
Gas% Lower Range	
Ext.Cutoff Trigger	Selection of the switching point for externally switching off the output via the analog input. If the switching point is exceeded, the flow measurement is set to zero. Possible switching points: > 4 mA, > 8 mA, > 12 mA.
Liquid Mass Corr.	Selection of the correction method for liquid mass measurement in operating mode 'Liquid Mass'. <ul style="list-style-type: none"> - None: Liquid mass flow, based on direct determination of the operating density via analog input, HART input, or a constant preset value. - Density Corr.: Liquid mass flow, based on density under reference conditions and density expansion coefficient. - Volume Corr.: Liquid mass flow, based on density under reference conditions and volume expansion coefficient. See Section 4.9.2 HART Inout for further information.

Menu/parameter	Description
Easy Setup	
Water/Steam Type	<p>If 'Steam/Water Mass' is selected as the operating mode, a further selection 'Water/Steam Type' must be chosen. Options are:</p> <ul style="list-style-type: none"> - Superheated steam - Saturated steam - Hot Water <p>See Section 4.9.8 Operating modes and Section 4.9.10 Energy measurement for steam/hot water in accordance with IAPWS-IF97 for additional information.</p>
Density Selection	<p>Selection of the steam density source in operating mode 'Steam/Water Mass'.</p> <ul style="list-style-type: none"> - Ext. Density: Remote density transmitter at HART or analog input. - Calc. From P&T: Calculation of the density for saturated steam and overheated steam using a remote pressure transmitter and the integrated temperature sensor. - Calc. From T: Calculation of the density for saturated steam using the integrated temperature sensor. - Calc. From P: Calculation of the density from the pressure only.
Energy calc. method	<p>Selection of the type of energy calculation in the operating mode Steam/Water Energy.</p> <ul style="list-style-type: none"> - Gross energy: The amount of energy that flows through the device is recorded. Any energy re-flow in form of condensate is not considered. - Net energy: The amount of energy that flows through the device is recorded. Any energy re-flow in form of condensate is deducted again from the amount of energy. <p>See Section 4.9.8 Operating modes and Section 4.9.10 Energy measurement for steam/hot water in accordance with IAPWS-IF97 for additional information.</p>
Ref. Density	Setting of the standard density of the measuring medium.
Preset Density	Setting of the density (operating density) of the measuring medium as a constant.
Ref. Temperature	Setting of the reference temperature.
Preset Int.Temp	Setting of the measuring medium temperature as a constant. The value entered must correspond as closely as possible to the temperature of the measuring medium in the meter tube.
Preset Ext.Temp	Adjustment of the return flow temperature as constant for the calculation of net energy consumption.
Preset Pressure(abs)	Setting of the measuring medium pressure as a constant.
Preset Gas Content	Setting of the methane content as a constant.
Q_v max	
Q_n Max	
Q_{vp} Max	Setting of the flow rate or energy quantity at which the current output is to output 20 mA (100%).
Q_{np} Max	The value entered must be at least 15% of $Q_{...}maxDN$.
Q_m Max	
Q_{power} Max	

Menu/parameter	Description
Easy Setup	
Damping Q_v	
Damping Q_n	Setting of the damping (the value relates to 1 T [Tau]).
Damping Q_{vp}	The value relates to a step change in the flow rate or energy quantity.
Damping Q_{np}	The value affects the instantaneous value in the process display and at the current output.
Damping Q_m	Default setting: 1 second
Damping Q_{power}	
Temp->I=0%	Setting of the temperature at which the current output is to output 20 mA or 4 mA.
Temp->I=100%	Only available if parameter 'OutputValue' has been set to 'Temperature'.
Damping Temperature	Setting of the damping (the value relates to 1 T [Tau]). The value relates to a step change in the temperature. The value affects the instantaneous value in the process display and at the current output.
Iout at Alarm	Selection of status of the current output in error condition. The output 'min.' or 'max.' current is set in the subsequent menu.
Low Alarm Value	Sets the current for min. alarm.
High Alarm Value	Sets the current for max. alarm.
Auto Zero	<p>Starts the automatic zero point balancing using  .</p> <p>Note: Prior to starting the zero point adjustment, make sure that:</p> <ul style="list-style-type: none"> - There is no flow through the sensor (close all valves, shut-off devices etc.) - The sensor must be filled completely with measuring medium for measurement. - The adjustment process takes approximately 45 seconds. - If automatic zero point balancing does not yield the desired results, see Section 5.12 Zero point balance under operating conditions.
Low Flow Cutoff	<p>Sets the switching threshold for the low flow cut-off. The set value relates to the $Q_{...maxDNvalue}$ in the selected operating mode.</p> <p>If the flow rate is below the switching threshold, there is no flow measurement. The setting of 0% deactivates the low flow cut-off.</p>



Parameter descriptions

5.11.2 Menu: Device Info

Note

This menu is only used to display the device parameters. The parameters are displayed independently of the configured access level, but cannot be changed.

Menu/parameter	Description
Device Info	
Sensor	Selection of submenu 'Sensor' using .
Transmitter	Selection of submenu 'Transmitter' using .
Device Info/Sensor	
Sensor Type	Displays the sensor type. - Vortex: Vortex flowmeters VLM30
Meter(V) Size, Meter(S) Size	Displays the sensor nominal diameter.
Q_{vMax_DN}	Display of the maximum configurable upper range value for the respective operating mode. For information purposes only; the value cannot be changed – it is calculated from $Q_{...MaxDN}$ for the respective medium and the set parameters such as density, pressure, or temperature.
Q_{vpMax_DN}	
Q_{mMax_DN}	
Q_{nMax_DN}	
Q_{npMax_DN}	
$Q_{powerMax_DN}$	
Sensor ID	Displays the ID number of the sensor.
SAP/ERP No.	Displays the order number of the sensor.
Sensor Run Hours	Displays the operating hours of the sensor.
Calibration	
Device Info/Sensor/Calibration	
Cal. Date	Date of sensor calibration.
Cal. Cert. No.	Identification (no.) of the relevant calibration certificate.
Cal. Location	Location of sensor calibration.

Menu/parameter	Description
Device Info/Transmitter	
Transmitter Type	Displays the transmitter type.
Transmitter ID	Displays the transmitter ID number.
SAP/ERP No.	Displays the order number of the transmitter.
Transmitter Version	Selection of submenu ' Transmitter Version ' using  .
Transmitter Run Hours	Displays the operating hours of the transmitter.
Calibration	
	Selection of submenu ' Calibration ' using  .
Manufacturer	Name of manufacturer.
Street	Address of manufacturer (street).
City	Address of manufacturer (city).
Phone	Telephone number of manufacturer.

Device Info/Transmitter/Transmitter Version

Transmitter FW Ver.	Displays the transmitter software version.
Transmitter HW Ver.	Displays the transmitter hardware version.
Frontend FW Version	Displays the sensor software version.
Frontend HW Version	Displays the sensor hardware version.
Bootloader Version	Displays the boot loader version.

Note





The firmware version specified on the name plate is a combination of the transmitter software version and the sensor software version.

Device Info/Transmitter/Calibration

Cal. Date	Date of transmitter calibration.
Cal. Cert. No.	Identification (no.) of the relevant calibration certificate.
Cal. Location	Location of transmitter calibration.

Parameter descriptions

5.11.3 Menu: Device Setup

Menu/parameter	Description
Device Setup	
Access Control	Selection of submenu 'Access Control' using  .
Sensor	Selection of submenu 'Sensor' using  .
Transmitter	Selection of submenu 'Transmitter' using  .
Plant/Customised	Selection of submenu 'Plant/Customised' using  .



Device Setup/Access Control

Standard Password	Entry/change of the password for the 'Standard' access level.
Read Only Switch	Display of switch position of the write protection switch (hardware write protection). See Section 4.9.3 DIP switch on the HART® communication board or Section 4.9.5 DIP switch on the Modbus communication board.

Device Setup/Sensor

Q_{vMax_DN}	
Q_{vpMax_DN}	
Q_{mMax_DN}	
Q_{nMax_DN}	
Q_{npMax_DN}	
$Q_{powerMax_DN}$	
Q_{vMax}	
Q_{vpMax}	
Q_{mMax}	Setting of the flow rate or energy quantity at which the current output is to output 20 mA (100%).
Q_{nMax}	The value entered must be at least 15% of $Q_{...max_DN}$.
Q_{npMax}	
$Q_{powerMax}$	
Sensor Location Tag	Enter the TAG number of the flowmeter sensor (shown in the upper left of the process display). Alphanumeric, maximum 20 characters.
Sensor TAG	Enter the TAG number for the measuring sensor. Alphanumeric, maximum 20 characters.





Menu/parameter	Description
Device Setup	
Units	Select the required transmitter measuring units using the right hand button 
Damping Q_v	
Damping Q_{np}	Setting of the damping (the value relates to 1 T [Tau]).
Damping Q_m	The value relates to a step change in the flow rate, energy quantity, or temperature.
Damping Q_n	The value affects the instantaneous value in the process display and at the current output.
Damping Q_{np}	Default setting: 1 second
Damping Q_{power}	
Damping Temperature	
Low Flow Cutoff	Sets the switching threshold for the low flow cut-off. The set value relates to the Q_{maxDN} value in the selected operating mode. If the flow rate is below the switching threshold, there is no flow measurement. The setting of 0% deactivates the low flow cut-off.
Device Setup/Transmitter/Units	
Unit Q_v	Selection of unit for volume flow. $m^3/s, m^3/min, m^3/h, m^3/Tag, ft^3/s, ft^3/min, ft^3/h, ft^3/Tag, l/s, l/min, l/h, l/Tag, kl/s, kl/min, kl/h, kl/Tag, us\ gal/s, usgal/min, us\ gal/h, us\ gal/Tag, imperial\ gal/s, imperial\ gal/min, imperial\ gal/h, imperial\ gal/day, barrel/s, barrels/min, barrel/h, barrels/day$ Factory setting: l/min
Unit Q_m	Selection of unit for mass flow. g/s, g/min, g/h, kg/s, kg/min, kg/h, kg/day
Unit Q_{nv}	Selection of unit for the standard volume flow. $m^3/s, m^3/min, m^3/h, m^3/Tag, ft^3/s, ft^3/min, ft^3/h, ft^3/Tag, l/s, l/min, l/h, l/Tag, kl/s, kl/min, kl/h, kl/Tag, us\ gal/s, usgal/min, us\ gal/h, us\ gal/Tag, imperial\ gal/s, imperial\ gal/min, imperial\ gal/h, imperial\ gal/day, barrel/s, barrels/min, barrel/h, barrels/day$ Factory setting: l/min
Unit Q_{power}	Selection of unit for energy measurement. W, MW, KW, KJ/s, KJ/min, KJ/h, KJ/day, MJ/h
Unit Density	Selection of unit for density. $kg/m^3, g/cm^3, kg/l, g/ml, g/l, lb/in, lb/ft^3$
Unit Temperature	Selection of unit for temperature. kelvin, celsius, fahrenheit
Unit Pressure	Selection of unit for pressure measurement. Pa, MPa, KPa, HPa, bar, mbar, psi, kg/cm^2
Unit Volume	Selection of unit for the volume totaliser. $m^3, ft^3, l, milli\ l, hecto\ l, imp\ gallon, us\ gallon, us\ barrels\ beer$

Menu/parameter	Description
Device Setup/Transmitter/Units	
Unit Mass	Selection of unit for the mass counter. g, kg, t, pounds, unze
Unit Std/Norm Vol.	Selection of unit for the standard volume totaliser. m ³ , ft ³ , l, milli l, hecto l, imp gallon, us gallon, us barrels beer
Unit Energy	Selection of unit for the energy counter. J, KJ, MJ, KWH
Device Setup/Plant/Customised	
Operating mode	Allows selection of the device operating mode (only for devices with HART or Modbus communication). See Section 4.9.8 Operating modes for further information.
Compensation Setting	Users may select specific measuring compensation parameters depending on the application using  .
Field optimisation	Specific parameters may be selected to enhance performance depending on the application/conditions using  .
Device Setup/Plant/Customised/Compensation Setting	
Liquid Mass Corr.	Selection of the correction method for liquid mass measurement in operating mode 'Liquid Mass'. <ul style="list-style-type: none"> - None: Liquid mass flow, based on direct determination of the operating density via analog input, HART input, or a constant preset value. - Density Corr.: Liquid mass flow, based on density under reference conditions and density expansion coefficient. - Volume Corr.: Liquid mass flow, based on density under reference conditions and volume expansion coefficient. See Section 4.9.8 Operating modes for further information.
Volume Exp.Coef.	Setting of the volume expansion coefficient. See Section 4.9.8 Operating modes for further information.
Density/Exp.Coef.	Setting of the density expansion coefficient. See Section 4.9.8 Operating modes for further information.
Specific Heat Capacity	Setting of the calorific value for the measuring medium in operating mode 'Gas Power'. See Section 4.9.8 Operating modes for further information.



Menu/parameter	Description
Device Setup/Plant/Customised/Field optimization	
Ref. Density	Setting of the standard density of the measuring medium.
Preset Density	Setting of the density (operating density) of the measuring medium as a constant.
Ref. Temperature	Setting of the reference temperature.
Preset Int.Temp	Setting of the measuring medium temperature as a constant. The value entered must correspond as closely as possible to the temperature of the measuring medium in the meter tube.
Preset Ext.Temp	Adjustment of the return flow temperature as constant for the calculation of net energy consumption.
Preset Pressure(abs)	Setting of the measuring medium pressure as a constant.
Preset Gas Content	Setting of the methane content as a constant.
Dynamic Viscosity	Setting of the dynamic viscosity of the measuring medium.
Temperature Offset	<p>Setting of the offset correction for the internal temperature measurement. Any deviation between the internal temperature measurement and an external temperature measurement can be corrected here. When doing this, the correction value must be offset against the existing balancing value. The correction can significantly improve accuracy; e.g. for a saturated steam measurement that does not take pressure into account. The temperature sensor is factory-calibrated at 22 to 28 °C (71.6 °F to 82.4 °F). At operating temperatures significantly outside of this range, errors of up to ±2 K can occur, which can be corrected under operating conditions.</p>
Auto Zero	<p>Starts the automatic zero point balancing using .</p> <p>NOTICE</p> <p>Prior to starting the zero point adjustment, make sure that:</p> <ul style="list-style-type: none"> - There is no flow through the sensor (close all valves, shut-off devices etc.). - The sensor must be filled completely with measuring medium for measurement. - The adjustment process takes approximately 45 seconds. - If automatic zero point balancing does not yield the desired results, see Section 5.12 Zero point balance under operating conditions.
Auto Zero status	<p>Display of whether automatic zero point balancing has been performed. If the zero point is not stable (flow indicator for zero flow), automatic balancing must be performed.</p>
Low Flow Thld.	<p>Setting of manual zero point balancing. The higher the value entered, the lower the sensitivity of the sensor.</p> <p>Setting range: 7 to 2000.</p> <p>See Section 5.12 Zero point balance under operating conditions.</p>
Advanced filters	<p>3 selections possible:</p> <ol style="list-style-type: none"> 1. Off. 2. Stalling filter to eliminate drop-offs in the lower range. 3. Noise filter to eliminate noise effects on the output.

Parameter descriptions



5.11.4 Menu: Display

Menu/parameter	Description
Display	
Language	Selection of menu language.
Contrast	Contrast setting for the LCD display.
Operator Pages	Selection of submenu 'Operator Pages' using . Up to four user-specific operator pages (layouts) can be configured for the process display. If multiple operator pages have been configured, these can be scrolled through manually on the information level. In the factory setting only Operator Page 1 is enabled.
Autoscroll	If Multiplex operation is enabled, you can also activate the 'Autoscroll' function on the information level of the operator menu. In this function, operator pages are automatically displayed in succession on the process screen, changing every 10 seconds. Manual scrolling through pre-configured operator pages as described above is no longer necessary. When Auto scroll mode is enabled, the icon  is displayed in the lower left corner of the screen.
Flowrate Format	Selection of number of decimal places (maximum 12) used to display the corresponding process variables.
Totaliser Format	
Date/Time Format	Set the display format for the date and time.
Display Test	Start the test of the LCD display with .
Display/Operator Pages	
Operator Page 1	Selection of submenu 'Operator Page 1' using  .
Operator Page 2	Selection of submenu 'Operator Page 2' using  .
Operator Page 3	Selection of submenu 'Operator Page 3' using  .
Operator Page 4	Selection of submenu 'Operator Page 4' using  .
Display/Operator Pages/Operator Page 1 ... n	
Display Mode	Configure each operator page. The following versions can be selected: Off, Graph Format, 1x4, 1x6, 1x6 bar, 1x6, 1x6 bar, 1x9, 1x9 bar, 2x9, 2x9 bar, 3x9, 4x9. Selecting 'Off' deactivates the corresponding operator page.
1st Line	
2nd Line	Selection of process variable displayed in the respective row.
3rd Line	
Bargraph	Selection of process variable displayed as a bar graph.

5.11.5 Menu: Input/Output

Menu/parameter	Description
Input/Output	
Current Out	Selection of submenu 'Current Out' using  .
DO Function	Selection of submenu 'DO Function' using  .
Field Input	Selection of submenu 'Field Input' using  .
Input/Output/Current Out	
	Selection of the process variable issued at the current output.
Output Value	<ul style="list-style-type: none"> - Q: Flow. - T: Temperature.
$Q_v \rightarrow I = 100\%$	
$Q_{vp} \rightarrow I = 100\%$	
$Q_n \rightarrow I = 100\%$	Setting of the flow rate at which the current output is to output 20 mA (100%).
$Q_{np} \rightarrow I = 100\%$	The value range depends on the nominal diameter of the sensor and the operating mode selected.
$Q_m \rightarrow I = 100\%$	Parameters will be displayed only if 'Q: Flow' has been selected for parameter 'Output Value'.
$Q_{power} \rightarrow I = 100\%$	
Temp $\rightarrow I = 100\%$	Setting of the temperature limits at which the current output is to output 4 mA or 20 mA.
Temp $\rightarrow I = 0\%$	Parameters will be displayed only if 'T: Temperature' has been selected for Temp $\rightarrow I = 0\%$ parameter 'Output Value'.
Out at Alarm	Selection of status of the current output in error condition. The output 'high' or 'low' current is set in the subsequent menu.
Low Alarm Value	Sets the current for Low Alarm.
High Alarm Value	Sets the current for High Alarm.
	Select the status of the current output when the upper range value is up-scaled.
Out at Flow $> 103\%$	<ul style="list-style-type: none"> - Off: Error is not output through the current output. - High Alarm: The current output assumes the value for 'High Alarm'. The current output is 'frozen' at 20.5 mA and returns to the regular range once it falls below the upper range value. - Low Alarm: The current output assumes the value for 'Low Alarm'.

Menu: Input/Output

Menu/parameter	Description
Input/Output/DO Function	
Function	<p>Selection of the function for the digital output.</p> <ul style="list-style-type: none">- None: Digital output deactivated.- Logic on DO: Digital output as a binary output (e.g. as an alarm output).- Pulse on DO: Digital output DO1 as a pulse output. In pulse mode, pulses are output per unit (e.g. 1 pulse per m³).- Freq on DO: Digital output DO1 as a frequency output. In frequency mode, a frequency is issued that is proportional to the flow rate. The maximum frequency can be configured in accordance with the upper range value.
Setup Pulse Out	Selection of submenu 'Setup Pulse Out' using  .
Setup Freq Out	Selection of submenu 'Setup Freq Out' using  .
Alarm Config	Selection of submenu 'Alarm Config' using  .
Logic on DO	<p>Logic on DO Select switching properties for the binary output.</p> <ul style="list-style-type: none">- Normally Closed: Binary output to open a normally closed contact.- Normally Open: Binary output to close a normally open contact.

Input/Output/DO Function/Setup Pulse Out

Pulses Per Unit	Setting of the pulses per unit of the selected operating mode and pulse width for the 'Pulse on DO' function of the digital output. The pulse value relates to the set flow unit, not the totaliser unit.
Pulse Width	For the kW energy unit (1 kW = 1 kJ/s), the pulse output automatically refers to kJ, meaning that a pulse value of 1 would lead to 1 pulse per second at an energy flow of 1 kW. The maximum frequency of the pulse output is 10 kHz. The device automatically calculates the max. pulse width using Qmax and the pulse value. The pulse length and pulse pause are considered to be equal, with a safety factor of 1.1. Available only if the digital output has been configured as a pulse output.

Input/Output/DO Function/Setup Freq Out

Lower Frequency	Setting of the frequency range for the 'Freq on DO' function of the digital output
Upper Frequency	Available only if the digital output has been configured as a frequency output.

Input/Output/DO Function/Alarm Config



General Alarm	
Min Flowrate Alarm	
Max Flowrate Alarm	Each alarm can be activated separately. This allows for individual configuration when the digital output signals an alarm.
Min Sensor T Alarm	
Max Sensor T Alarm	
Flow Cutoff Alarm	

Menu: Input/Output

Menu/parameter	Description
Input/Output/Field Input	
	<p>Selection of the process variable measured via the analog input.</p> <ul style="list-style-type: none"> - None: No remote transmitter at the input. - Temperature: Remote temperature transmitter at the input (transmitter in the reverse flow of a heating or cooling cycle for net energy calculation or transmitter in the device outlet (see Section 3.4 Installation for external pressure and temperature measurement) for temperature compensation, if no internal temperature measurement is possible/desired). - Pressure: Remote pressure transmitter at the input. - Pressure(abs): Remote absolute pressure transmitter at the input. - Gas Content: Remote gas analyser at the input. - Density: Remote transmitter at the input. - Int.T: External temperature transmitter, e.g. for using a remote temperature transmitter instead of the internal temperature sensor to increase the accuracy or reduce the response time. <p>Refer to Section 3.18.6 Analog input 4 to 20 mA.</p>
Analog In Value	
T Ext. Upper Range	
T Ext. Lower Range	
T Int. Upper Range	
T Int. Lower Range	
Pressure Upper Range	Setting of the measuring range limits for the external transmitter at the analog input.
Pressure Lower Range	The upper value applies for a current of 20 mA at the analog input, the lower value for a current of 4 mA.
P(abs) Upper Range	The availability of this parameter depends on the process variable selected for the analog input.
P(abs) Lower Range	
Density Upper Range	
Density Lower Range	
Gas% Upper Range	
Gas% Lower Range	
Ext.Cutoff Trigger	<p>Selection of the switching point for externally switching off the output via the analog input.</p> <p>If the switching point is exceeded, the flow measurement is set to zero.</p> <p>Possible switching points: > 4 mA, > 8 mA, > 12 mA</p>
HART In Value	<p>Selection of the process variable measured via the HART input.</p> <p>For description, see parameter 'Analog In Value'.</p> <p>Refer to Section 3.18.7 HART communication with remote transmitter.</p>

Parameter descriptions

5.11.6 Menu: Process Alarm

Menu/parameter	Description
Process Alarm	
Diagnostic History	Display of the alarm history.
Clear History	Reset of the alarm history.
Group Masking	Selection of submenu 'Group Masking' using  .
Individual Masking	Selection of submenu 'Individual Masking' using  .
Alarm Limits	Selection of submenu 'Alarm Limits' using  .

Process Alarm/Group Masking

Maintenance Required	Alarm messages are divided into groups.
Function Check	If masking is activated for a group (On), no alarm is issued.
Out Of Specification	For more detailed information, see Section 7 Diagnosis/error messages .

Process Alarm/Individual Masking

Min Flowrate Alarm	
Max Flowrate Alarm	
Flow > 103%	Individual alarm messages can also be masked. These are not included in the masking for the group. If masking is activated for an alarm (On), no alarm occurs.
Flow Cutoff Alarm	For more detailed information, see Section 7 Diagnosis/error messages .
Int. T Sensor Fault	There are no alarms masked by default.
Medium Temp Off Spec.	
Housing Temp Off Spec.	

Process Alarm/Alarm Limits

Min Q _v Alarm	Sets the minimum/maximum limit value for volume measurement. If the volume flow exceeds or falls below the limit values, an alarm is triggered.
Max Q _v Alarm	
Min Q _m Alarm	Sets the minimum/maximum limit value for mass measurement. If the mass flow up-scales or down-scales the limit values, an alarm is triggered.
Max Q _m Alarm	
Min Temp.Alarm	Sets the minimum/maximum limit value for temperature measurement. If the measuring medium temperature exceeds or falls below the limit values, an alarm is triggered.
Max Temp.Alarm	
Min P(abs) Alarm	Sets the minimum/maximum limit value for pressure measurement. If the pressure exceeds or falls below the limit values, an alarm is triggered.
Max P(abs) Alarm	

Menu: Process Alarm

Menu/parameter	Description
Process Alarm/Alarm Limits (cont)	
Min Re Alarm	Setting of the minimum/maximum limit values for the Reynolds number (Re). If the Reynolds number (Re) exceeds or falls below the limit values, an alarm is triggered.
No HART Input Alarm	Setting of the delay time in seconds for error message 'No HART Burst In' if the external HART input has been activated. Value range: 5 to 10800 seconds (3 hours).



Menu: Communication for devices with HART® communication

Menu/parameter	Description
Communication	
HART	Selection of submenu 'HART' using  .





Communication/HART

Device Address	Selection of HART device address. Note: The HART protocol has provisions for creating a bus with up to 15 devices (1 to 15)). If an address greater than 0 is set, the device operates in multidrop mode. The current output is then fixed at 4 mA. Apart from that, the current output is only used for HART communication.
Tag	Entry of a HART TAG number as unique identifier for the device. Alphanumeric, a maximum of 8 characters, upper case only, no special characters.
Descriptor	Entry of a HART descriptor. Alphanumeric, a maximum of 16 characters, upper case only, no special characters.
Message	Display of the alphanumeric TAG number.
Manuf. ID	Display of the HART manufacturer ID = 26
Device ID	Display of the HART device ID.
Last Command	Display of the most recently sent HART command.

5.11.7 Menu: Communication for devices with Modbus® communication

Menu/parameter	Description
Communication	
Service Port	Selection of submenu 'Service Port' using  .
MODBUS	Selection of submenu 'MODBUS' using  .
Communication/Service Port	
Baud Rate	Selection of the transmission speed (baud rate) for the service port. Factory setting: 9600 bd.
Communication/MODBUS	
Address	Setting of the Modbus device address. Setting range: 1 to 247. Factory setting: 247
Baud Rate	Selection of the transmission speed (bit rate) for the Modbus communication. <ul style="list-style-type: none"> - 1200 bps - 2400 bps - 4800 bps - 9600 bps Factory setting: 9600 bps
Parity	Selection of the parity for the Modbus communication. <ul style="list-style-type: none"> - NULL - Even - Odd Factory setting: NULL
RespDelayTime	Setting of the pause time in milliseconds after receiving a Modbus command. The device sends a response no earlier than expiration of the set pause time. Setting range: 0 to 200 ms Factory setting: 50 ms
Address Offset	Selection of the address offset for the Modbus address (PLC Base 0 or PLC Base 1). In the Modbus protocol, there are two options for register addressing. Depending on the manufacturer, the start address of the register is defined as '0'(e.g. 40000) or '1' (e.g. 40001). <ul style="list-style-type: none"> - Zero Base: Modbus addresses PLC Base 0 - One Base: Modbus addresses PLC Base 1 Factory setting: One Base

5.11.8 Menu: Diagnostics

Menu/parameter	Description
Diagnostics	
Diagnosis Control	Selection of submenu 'Diagnosis Control' using  .
Diagnosis Values	Selection of submenu 'Diagnosis Values' using  .
Simulation Mode	Selection of submenu 'Simulation Mode' using  .
Output Readings	Selection of submenu 'Output Readings' using  .
Alarm Simulation	Selection of submenu 'Alarm Simulation' using  .

Diagnostics/Diagnosis Control

Sensor Self Check	Start of sensor self-test using  . The device runs a self-test of the Piezo sensor and PT100 temperature sensor for wire breaks or short-circuits. Any errors detected will immediately trigger a corresponding error message. Refer to Section 7.8 Possible error messages .
Maintenance Cycle	Sets the service interval. After the maintenance interval has expired, the corresponding error message 'Maintenance Warning' is set. The setting '0' deactivates the maintenance interval.

Diagnostics/Diagnosis Values

Reynolds Number	Display of the current Reynolds number (Re).
Ext. Temperature	Display of the current measuring medium temperature.
Housing Temperature	Display of the current housing temperature in °C.
AI Value	Display of the current measured value at the analog input.

Menu: Diagnostics (cont)

Menu/parameter	Description
Diagnostics/Simulation Mode	
Off	
Volume Flow Unit	
Volume Flow	
Volume Flow[%]	
Mass Flow Unit	
Mass Flow	
Mass Flow[%]	Manual simulation of measured values. After selecting the value to be simulated, a corresponding parameter is displayed in the menu 'Diagnostics/Simulation Mode'.
Temperature Unit	The simulation value can be set here.
Medium Temperature	The output values correspond to the simulated flowrate entered.
Housing Temperature	Information 'Configuration' appears in the lower line of the display.
Current Out	Only one measured value/output can be selected for simulation.
Freq on DO	After power-up/restart of the device, the simulation is switched off.
Logic on DO	
Pulse on DO	
AI Value	
Sensor Freq	

Diagnostics/Output Readings





Current Out	
DO Pulse	
DO Frequency	Display the current values and statuses of the listed inputs and outputs.
DO State	

Diagnostics/Alarm Simulation

Manual simulation of alarms/error messages.
The simulated alarm is selected by setting the parameter to the corresponding error.
Refer to Section **7 Diagnosis/error messages**.
The following error messages can be simulated:

Off, sim. current output, sim. switch output, Sig. Sensor Fault, Int. T Sensor Fault, Vbr. Sensor Fault, AI Out of Range, Max Flowrate Alarm, Max Int. Temp Alarm, AI Cut Off, Max Pressure Alarm, Min Flowrate Alarm, Min Int. Temp Alarm, Current Output Saturated, Min Pressure Alarm, Bad SNR, Sensor NV Error, Sensor Not Calibrated, Sync. Signal Error, Sensor Comm Error, Transmitter NV Error, AI Comm Error, Pulse Output Cutoff, Re. Out of Range, Wrong Steam Type, Maintenance Warning, Voltage Warning, Min Housing T Alarm, Flowrate Cutoff, Flowrate > 103%, Data Simulation, Alarm Simulation, Fixed Current Output, Current Output Fault, CO Readback High, CO Readback Low, NV Replace Warning, Sensor RAM Fault, Totaliser Stop, Totaliser Reset, No HART Burst In.

5.11.9 Menu: Totaliser

Menu/parameter	Description
Totaliser	
Start	Selection of submenu 'Start' using Select  .
Stop	Selection of submenu 'Stop' using Select  .
Reset	Selection of submenu 'Reset' using Select  .
Preset	Selection of submenu 'Preset' using Select  .

Totaliser/Start

All Totalisers	Starts all counters.
Act.Volume Totaliser	
Std.Volume Totaliser	
Mass Totaliser	Starts the selected counters.
Energy Totaliser	
Net Act.Vol.Totaliser	
Net Std.Vol.Totaliser	



Totaliser/Stops

All Totalisers	Stops all counters.
Act.Volume Totaliser	
Std.Volume Totaliser	
Mass Totaliser	Stops the selected counters.
Energy Totaliser	
Net Act.Vol.Totaliser	
Net Std.Vol.Totaliser	

Totaliser/Reset

All Totalisers	Resets all counters.
Act.Volume Totaliser	
Std.Volume Totaliser	
Mass Totaliser	Resets the selected counters.
Energy Totaliser	
Net Act.Vol.Totaliser	
Net Std.Vol.Totaliser	

Menu: Totaliser (cont)

Menu/parameter	Description
Totaliser/Preset	
Enter Preset Value	Selection of submenu 'Enter Preset Value' using Select  .
Set To Preset Value	Selection of submenu 'Set To Preset Value' using Select  .

Totaliser/Preset/Enter Preset Value

Act.Volume Totaliser	
Std.Volume Totaliser	
Mass Totaliser	
Energy Totaliser	Input from meter readings (e.g. when replacing the transmitter).
Net Act.Vol.Totaliser	
Net Std.Vol.Totaliser	

Totaliser/Preset/Set Preset Value

Act.Volume Totaliser	
Std.Volume Totaliser	
Mass Totaliser	Sets the counters to the values entered under 'Totaliser/Preset/Enter Preset Value'.
Energy Totaliser	
Net Act.Vol.Totaliser	
Net Std.Vol.Totaliser	

Counter overflow

All counters count up to 10 million (in the selected totaliser unit). After a value of 10 million is reached, the corresponding overflow counter is incremented by one and the totaliser value is reset to zero to continue counting the flow.

To indicate in the process display that an overflow has occurred, a corresponding warning is displayed on the LCD indicator.

Threshold for counter overflow = 10,000,000 Kg (m³ or KJ) Counter reading = Current counter reading + (number of counter overflows × 10,000,000).

5.12 Zero point balance under operating conditions

Automatic zero point balancing

With automatic zero point balancing, the transmitter determines the noise threshold of the sensor signal automatically. As long as the sensor signal remains above the determined noise threshold, this is recognised as a valid flow signal.

Automatic zero point balancing should be rerun in the event of the following changes:

- Change in external installation conditions, such as more or fewer vibrations, pulsations, or electromagnetic field interspersions.
- Replacement of the communication board in the transmitter.
- Replacement of the sensor or sensor electronics.

For zero point balancing, the conditions in the meter tube have to correspond to the operating conditions for zero flow.

Automatic zero point balancing is started in the 'Device Setup/Plant/Customized/Field optimization/Auto Zero' menu.

Note: If the results of automatic zero point balancing are not acceptable, manual zero point balancing can be performed.

Manual zero point balancing

For manual zero point balancing, the noise threshold of the sensor signal must be determined manually. The same requirements apply for manual zero point balancing as for automatic zero point balancing.

1. Read out the signal amplitude of the source of interference in the 'Service/Sensor/Sig. Amplitude' menu. Note down the maximum value of the signal amplitude.
2. Multiply the calculated maximum value by a safety factor of between 1.2 and 2.0. Experience has shown that a value of 1.7 yields very good results.
3. Enter the calculated value in the 'Device Setup/Field optimization/Low Flow Thld.' menu.
4. Check the zero point setting in the process display/at the current output.
5. Check whether the lowest desired lower range value can be achieved with the new zero point setting.

Note: Zero point settings > 200 indicate an elevated potential for interference (vibrations, pulsations or EMC interference). The installation location and installation of the device should therefore be checked and appropriate measures taken, if necessary, to eliminate interference.

5.13 Advanced filter

In order to eliminate spikes on the output, caused by drop-offs or temporary loss of the signal, 2 optional advanced filters are available. Activating one of the advanced filters will have an impact on the device reaction time on real flow changes. The setting of the damping is no longer relevant for the meter response time. The default device set-up for the filters is 'off'.

Stalling filter

This filter is to eliminate drop-offs on the output signal caused by signal loss caused by temporarily poor flow pulses. As long as the quality of the picked-up pulses are sufficient to determine a flow frequency, the filter can help to stabilise the signal quality specifically at the low end. This filter only works in the lower 30% range of Q_{max} DN of the device. An additional measuring error is possible.

Noise filter

This filter is to minimise noise effects on the output in both directions, up and down. This filter works over the full meter range and help to eliminate noise effects caused by the application, e.g. pulses, cavitation, vibration or the environment, e.g. EMC impact. An additional measuring error is possible.

6. Maintenance

6.1 Safety instructions

	<p>Warning! Risk of injury due to live parts! When the housing is open, contact protection is not provided and EMC protection is limited.</p> <p>- Before opening the housing, switch off the power supply.</p>
---	--

	<p>Caution! Risk of burns due to hot measuring media The device surface temperature may exceed 70 °C (158 °F), depending on the measuring medium temperature!</p> <p>- Before starting work on the device, make sure that it has cooled sufficiently.</p>
---	--

	<p>Damage to components! The electronic components of the printed circuit board can be damaged by static electricity (observe ESD guidelines).</p> <p>- Make sure that the static electricity in your body is discharged before touching electronic components.</p>
---	--

Corrective maintenance work may only be performed by trained personnel.

- Before removing the device, depressurise it along with any adjacent lines or vessels.
- Check whether hazardous materials have been used as measuring medium before opening the device. Residual amounts of hazardous material may still be present in the device and could escape when it is opened.

Within the scope of operator responsibility, check the following as part of a regular inspection:

- pressure-carrying walls/pressure equipment liner.
- the measurement-related function.
- the leak tightness.
- the wear (corrosion).

6.2 Cleaning

When cleaning the exterior of meters, make sure that the cleaning agent used does not corrode the housing surface and the seals.

To avoid static charge, a damp cloth must be used for cleaning.

6.3 Sensor

Essentially no maintenance is required for the sensor. The following items should be checked annually:

- Ambient conditions (air circulation, humidity).
- Tightness of the process connections.
- Cable entries and cover screws.
- Operational reliability of the power supply, lightning protection, and station ground.

7. Diagnosis/error messages

7.1 General Notes

The following checks should be performed whenever a malfunction occurs. This will help to isolate and remedy the cause of the malfunction.

7.2 Sensor

Check the following:

- Has the device been installed in accordance with the installation conditions?
- Have the nominal diameter and measuring range been selected in accordance with the application?
- Does the flow direction correspond to the direction indicated on the device?
- Have the electrical connections been completed correctly?
- Run the device self-test in the 'Diagnostics/Diagnosis Control/Sensor Self Check' menu. Take note of any error messages.

7.3 Application conditions

Check the following:

- Do the density and viscosity of the measuring medium correspond to the requirements of the selected nominal diameter of the device?
- Is the measuring medium a multiphase medium?
- Gas inclusions in liquid measuring media and condensate in gaseous measuring media can cause significant measuring errors. Multiphase media should therefore be avoided.

7.4 Zero point balancing

Complete zero point balancing in accordance with Section **5.12 Zero point balance under operating conditions**.

7.5 Pipe vibrations

Please observe the following points:

- Take appropriate measures to dampen pipe vibrations at the sensor inlet and outlet.
- Take suitable measures to dampen vibrations in the kHz range, which are transferred by brackets, for example.

7.6 Transmitter

Check the following:

- Check the supply voltage at the transmitter terminals. Check the length of the power supply cable, see Section 3.18.4 **Current output/HART output**.
- Make sure the transmitter unit is seated correctly. Check the transmitter plug connectors for damage.
- Check the following parameters in the order specified. Sensor Type: Swirl or Vortex (in accordance with the name plate). Meter(V) Size: Nominal diameter of the device (in accordance with the name plate). Active Mode/Medium Type: Corresponds to the application.
- Make sure the electrical connections of the device are correct.

The sensor, transmitter and power supply for the device should be connected to the same potential, if possible.

- The signal cable for the remote mount design must not be exposed to strong magnetic fields.



7.7 Calling up the error description

Additional details about the error that has occurred can be called up on the information level.

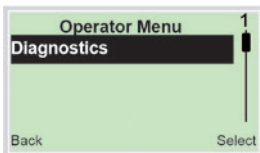

1. Use  to switch to the information level (Operator Menu).



2. Use / to select the submenu 'Diagnostics'.
3. Confirm the selection with .

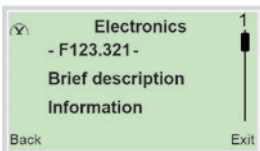

The error message is shown on the display according to priority.

The first line shows the area in which the error has occurred.

The second line shows the unique error number. It is made up of the priority (Fxxx) and the error position (.xxx)

The next lines show a brief description of the error and information on how to remedy it.

You absolutely need to scroll the display further to read the error message in more detail.

Note: For a detailed description of the error messages and information on troubleshooting, see the following pages.

7.8 Possible error messages

The error messages are divided into four groups in accordance with the NAMUR classification scheme. Depending on the model variant, not all error messages are always available.

7.8.1 Errors

Error no./ Range	Text on the LCD display	Cause	Remedy
HART/Modbus			
F217.041/ Electronics*	CO Readback High	Incorrectly calibrated current output or faulty electronics.	Contact SXS.
F216.042/ Electronics*	CO Readback Low	Incorrectly calibrated current output or faulty electronics.	Contact SXS.
F215.020/ Electronics	Sensor Comm Error	Communication errors between sensor and transmitter.	Check electrical connections between sensor and transmitter.
F214.019/ Electronics	Sync. Signal Error	Error in SensorMemory.	Switch transmitter off and back on again. If the error remains, contact SXS.
F213.000/ Sensor	Sig. Sensor Fault	Errors in sensor self-test. Signal errors from Piezo sensor.	Contact SXS.
F212.001/ Sensor*	Int. T Sensor Fault	Errors in internal temperature sensor.	Contact SXS.
F211.002/ Sensor	Vbr.Sensor Fault	Errors in sensor self-test. Signal errors from Piezo sensor.	Contact SXS.
F210.016/ Electronics	Bad SNR	Signal-to-noise ratio for the sensor signal is outside of the set limit values.	Increase the flow rate. Check the setting in the 'Process Alarm/Alarm Limits' menu and adjust if necessary.
F209.017/ Electronics	Sensor NV Error	Faulty transmitter electronics.	Replace transmitter electronics or contact SXS.
F208.044/ Electronics	Sensor RAM Fault	Faulty transmitter electronics.	Replace transmitter electronics or contact SXS.
F207.023/ Electronics	Transmitter NV Error	Faulty communication board.	Replace the communication board or contact SXS.
F203.040/ Electronics*	Current Output Fault	Current output errors.	Contact SXS.

* Not for devices with Modbus communication

7.8.2 Function check

Error no./ Range	Text on the LCD display	Cause	Remedy
HART/Modbus			
C202.024/ Electronics*	AI Comm Error	Errors in signal at analog input.	Check the electrical connection at the analog input.
-----	Not Remove FF Check	One of the blocks is out of service.	Contact SXS
C155.045/ Configuration	Totaliser Stop	Counter stopped.	Start counter in menu 'Totaliser/ Start'.
C154.039/ Configuration*	Fixed Current Output	The current output is simulated and is currently set to a specific value. The error message is displayed if the HART address is not 0 (HART multidrop mode, current output is set permanently to 4 mA).	In the 'Diagnostics/Simulation Mode' menu, deactivate simulation mode. Alternatively, set the HART address to 0 in the 'Communication' menu.
-----	No AO Input	Error in AO block.	Check DCS signal.
C153.047/ Configuration*	No HART Burst In	Errors in signal at HART input.	Check HART communication with remote transmitter. If necessary, deactivate monitoring of the external HART signal in the 'Process Alarm/Alarm Limits/No HART Input Alarm' menu. Refer to Section 3.18.7 HART® communication with remote transmitter.
C152.038/ Configuration	Alarm Simulation	An alarm is being simulated. Alarm simulation is switched on.	Switch off alarm simulation in the 'Diagnostics/Alarm Simulation' menu.
C151.037/ Configuration	Data Simulation	A process variable is being simulated. Simulation mode is activated.	In the 'Diagnostics/Simulation Mode' menu, deactivate simulation mode. If necessary, deactivate the simulation via the HART communication.

* Not for devices with Modbus communication.

7.8.3 Operation outside of specifications (out of spec)

Error no./Range	Text on the LCD display	Cause	Remedy
HART/Modbus			
S116.030/ Operation	Wrong Steam Type	Incorrect steam type configured.	Check the steam type setting in the 'Device Setup/Plant/Customised/Water/Steam Type' menu.
S115.036/ Operation	Flowrate > 103%	The flow rate exceeds the configured upper range value by more than 3%.	Increase the upper range value in the 'Device Setup/Sensor' menu.
S114.004/ Operation	Max Flowrate Alarm	The present flow rate is greater than the max. alarm configured.	Reduce the flow rate or increase the value for the max. alarm.
S113.010/ Operation	Min Flowrate Alarm	The present flow rate is lower than the min.alarm configured.	Increase the flow rate or reduce the value for the min. alarm.
S112.005/ Operation	Max Int. Temp Alarm	The measuring medium temperature is greater than the max. alarm configured.	Check the measuring medium temperature or increase the value for the max. alarm.
S111.011/ Operation	Min Int. Temp Alarm	The measuring medium temperature is lower than the min. alarm configured.	Check the measuring medium temperature or reduce the value for the min. alarm.
S110.035/ Operation	Low Flow Cutoff	The instantaneous flow rate is lower than the set leak flow volume.	Increase flow rate or value for the low flow cut-off in the menu 'Device Setup/Transmitter/Low Flow Cutoff'.
S109.026/ Operation	Re. Out of Range	The Reynolds number (Re) is lower than the set minimum alarm. Measuring accuracy is reduced if the Reynolds number (Re) falls below a specific value. Refer to Measuring range tables in Section 10 Appendix.	Check the device set-up. Increase the flow rate. If necessary, reduce the value for the min. alarm.
S108.012/ Operation*	Current Output Saturated	The current output has fallen below or exceeded the measuring range limits. The process value output via the current output is outside of the set limits (3.8 to 20.5 mA).	Check the device set-up. Check the measuring range limit setting for the current output in the 'Input/Output/Current Out' menu and adjust if necessary.

* Not for devices with Modbus communication.

Operation outside of specifications (out of spec)

Error no./Range	Text on the LCD display	Cause	Remedy
HART/Modbus			
S107.006/ Operation*	AI Cut Off	External switching off of output via analog input is active.	Check analog input value. Check the switching point setting for the external output switch-off in the 'Input/Output/Field Input/Ext.Cutoff Trigger' menu and adjust if necessary.
S106.003/ Operation*	AI Out of Range	The signal at the analog input is outside the permissible limits of 3.8 to 20.5 mA.	Check analog input value.
S105.034/ Operation	Min Housing T Alarm	The ambient temperature of the transmitter is outside permissible limits.	Ensure that the ambient temperature of the transmitter is within permissible limits. Check the device installation in accordance with Section 3.1 installation conditions.
S104.033/ Operation*	Flowrate Cutoff		
S103.025/ Operation	Pulse Output Cutoff	Incorrect configuration of pulse output. The maximum pulse rate has been exceeded.	Check the pulse rate in the 'Input/Output/DO Function/Setup Pulse Out' menu and adjust if necessary.
S102.007/ Operation*	Max Pressure Alarm	The measuring medium pressure is greater than the max. alarm configured.	Check the measuring medium pressure or increase the value for the max. alarm.
S101.013/ Operation*	Min Pressure Alarm	The measuring medium pressure is lower than the min. alarm configured.	Check the measuring medium pressure or reduce the value for the min. alarm.

* Not for devices with Modbus communication.

7.8.4 Maintenance

Error no./Range	Text on the LCD display	Cause	Remedy
HART/Modbus			
M054.043/ Operation	NV Replace Warning	The communication board or frontend board has been replaced without downloading the system data. The system data was not downloaded correctly.	Download the system data, see Replacing the transmitter, downloading system data in Section 8 Repair.
M053.032/ Operation	Voltage Warning	The supply voltage to the transmitter is outside permissible limits.	Check the supply voltage at the transmitter terminals. Check the length of the power supply cable, see Section 3.18.4 Current output/HART output. Check the external power supply and replace if necessary.
M052.031/ Operation	Maintenance Warning	Maintenance interval reached.	Adjust the maintenance interval or contact SXS to have the device recalibrated.
M051.018/ Operation	Sensor Not Calibrated	The sensor has not been calibrated or the calibration status has not been set to 'Calibrated'.	Contact SXS to have the device recalibrated.

* Not for devices with Modbus communication

7.8.5 Response of the outputs to error messages

Error no./Range	Error text	Current output	Digital output	Error maskable?	
F217.041/ Electronics	---	CO Readback High	High Alarm	Collective alarm	No
F216.042/ Electronics	---	CO Readback Low	Low Alarm	Collective alarm	No
F215.020/ Electronics	F215.001/ Electronics	Sensor Comm Error		Collective alarm	No
F214.019/ Electronics	F214.002/Sensor Sync. Error			Collective alarm	No
F213.000/ Sensor	F213.003/Sensor Sig. Sensor Fault			Collective alarm	No
F212.001/ Sensor*	F212.004/Sensor Int. T Sensor Fault			Collective alarm	Menu 'Individual Masking'.
F211.002/Sensor Sensor Fault	F211.005/Sensor Vbr.		High Alarm or Low Alarm, depending on parameter 'Iout at Alarm'.	Collective alarm	No
F210.016/ Electronics	F210.006/ Electronics	Bad SNR		Collective alarm	No
F209.017/ Electronics	F209.007/ Electronics	Sensor NV Error		Collective alarm	No
F208.044/ Electronics	F207.008/ Electronics	Sensor RAM Fault		Collective alarm	No
F207.023/ Electronics	---	Transmitter NV Error		Collective alarm	No
F203.040/ Electronics*	---	Current Output Fault		Collective alarm	No
C202.024/ Electronics*		AI Comm Error		Collective alarm	No
---	C160.000/ Operation**	Not Remove FF Check	---	No change	No
C155.045/ Configuration	S155.023/ Operation	Totaliser Stop	Current value - no change.	No change	Menu 'Group Masking'.
C154.039/ Configuration*	---	Fixed Current Output	Fixed value set by simulation.	No change	Menu 'Group Masking'.

* If the Int. T Sensor Fault alarms or Flowrate > 103% are simulated, the current output assumes the value for High Alarm or Low Alarm, depending on the 'Iout at Alarm' parameter. The currently measured value is output for all other alarms.

** If the Int. T Sensor Fault, Flowrate > 103%, Max Flowrate Alarm, Min Flowrate Alarm alarms or Low Flow Cutoff are simulated, the digital output assumes the status, depending on the 'Alarm Config' parameter. The status remains unchanged for all other alarms.

Response of the outputs to error messages (contd.)

Error no./Range	Error text	Current output	Digital output	Error maskable?	
---	C153.009/ Operation	No AO Input	---	No change	Menu 'Individual Masking'.
C153.047/ Configuration	---	No HART Burst In	Current value - no change.	No change	Menu 'Group Masking'.
C152.038/ Configuration	C152.010/ Operation	Alarm Simulation	*	**	Menu 'Group Masking'.
C151.037/ Configuration	C151.011/ Operation	Data Simulation	Current or simulated value. Parameter "Simulation Mode/Current Out".	Current or simulated value. Parameter "Simulation Mode/Logic on DO".	Menu 'Group Masking'.
S116.030/ Operation	S116.022/ Operation	Wrong Steam Type	Current value - no change.	No change	Menu 'Group Masking'.
S115.036/ Operation	---	Flowrate > 103%	High Alarm or Low Alarm, depending on parameter 'Iout at Alarm'.	Collective alarm	Menu 'Individual Masking'.
S114.004/ Operation	S114.012/ Operation	Max Flowrate Alarm	Current value - no change.	Depending on parameter 'Max Flowrate Alarm'.	Menu 'Individual Masking'.
S113.010/ Operation	S113.013/ Operation	Min Flowrate Alarm	Current value - no change.	Depending on parameter 'Min Flowrate Alarm'.	Menu 'Individual Masking'.
S112.005/ Operation	S112.014/ Operation	Max Int. Temp Alarm	Current value - no change.	Depending on parameter 'Max Sensor T Alarm'.	Menu 'Individual Masking'.
S111.011/ Operation	S111.015/ Operation	Min Int. Temp Alarm	Current value - no change.	Depending on parameter 'Min Sensor T Alarm'.	Menu 'Individual Masking'.
S110.035/ Operation	S110.016/ Operation	Low Flow Cutoff	4 mA	Depending on parameter 'Flow Cutoff Alarm'.	Menu 'Individual Masking'.
S109.026/ Operation	S109.017/ Operation	Re. Out of Range	Current value - no change.	No change	Menu 'Group Masking'.
S108.012/ Operation	---	Current Output Saturated	Configured maximum current.	No change	Menu 'Group Masking'.

Response of the outputs to error messages (contd.)

Error no./Range	Error text	Current output	Digital output	Error maskable?	
S107.006/ Operation	---	AI Cut Off	4 mA	No change	Menu 'Group Masking'.
S106.003/ Operation	---	AI Out of Range	Current value - no change.	No change	Menu 'Group Masking'.
S105.034/ Operation	---	Flowrate Cutoff	Current value - no change.	No change	Menu 'Individual Masking'.
S104.033/ Operation	---	Min Housing T Alarm	Current value - no change.	No change	Menu 'Individual Masking'.
S103.025/ Operation	S103.018/ Operation	Pulse Output Cutoff	Current value - no change.	No change	Menu 'Group Masking'.
S102.007/ Operation	---	Max Pressure Alarm	Current value - no change.	No change	Menu 'Group Masking'.
S101.013/ Operation	---	Min Pressure Alarm	Current value - no change.	No change	Menu 'Group Masking'.
M054.043/ Operation	M54.019/ Operation	NV Replace Warning	Current value - no change.	No change	Menu 'Group Masking'.
M053.032/ Operation	---	Voltage Warning	Current value - no change.	No change	Menu 'Group Masking'.
M052.031/ Operation	M53.020/ Operation	Maintenance Warning	Current value - no change.	No change	Menu 'Group Masking'.
M051.018/ Operation	M52.021/ Operation	Sensor Not Calibrated	Current value - no change.	No change	Menu 'Group Masking'.

7.8.6 Malfunctions without error messages

Failure	Corrective action
No flow measurement when there is a flow through the piping	<p>See the general information in Section 7.1 General Notes.</p>
	<p>General</p> <p>Check whether the flow rate is within the selected measuring range limits of the device.</p>
	<p>Check the measuring tube for damage, foreign matter, and deposits that could impair the flow profile. Clean the meter tube if necessary.</p>
	<p>Sensor</p> <p>Check the guide body, bluff body, and Piezo sensor in the meter tube for damage.</p>
	<p>Overheating of the Piezo sensor as a result of the permissible measuring medium temperature having been exceeded can damage the Piezo sensor and impair the measurement.</p>
	<p>Application</p> <p>Check whether there is sufficient back pressure downstream of the device to prevent cavitation.</p>
	<p>For test purposes, increase the measuring medium pressure.</p>
	<p>For test purposes, increase/reduce the flow rate.</p>
	<p>Transmitter</p> <p>Determine the sensor frequency in the 'Diagnostics/Sensor Freq' menu. The frequency must correspond with the requirements set out in the measuring range tables. Refer to Measuring range tables in Section 10 Appendix. If the sensor frequency seems plausible, check the configuration of the transmitter and the electrical connection.</p>
	<p>Check the function of the outputs in the 'Diagnostics/Simulation Mode' menu.</p>
<p>Check the configuration of the outputs in the 'Input/Output' menu.</p>	
Incorrect flow measurement when there is a flow through the piping	<p>See the general information in Section 7.2 Sensor.</p>
	<p>General</p> <p>Check whether the flow rate is within the selected measuring range limits of the device.</p>
	<p>Sensor</p> <p>Check the meter tube gaskets. Even very small leaks can cause a hissing noise and impair the measurement. In the event of low flow rates in relation to the nominal diameter, this results in excessively high flow rates being measured. Hardly any errors occur with higher flow rates. If necessary, tighten the flange screws or replace the gaskets.</p>
	<p>Check the measuring tube for damage, foreign matter, and deposits that could impair the flow profile. Clean the meter tube if necessary.</p>

Malfunctions without error messages (contd.)

Failure	Corrective action	
	Application	<p>For test purposes, check the response of the device to changes in the flow.</p> <hr/> <p>Check whether the inside diameters of the sensor and piping are different from one another.</p> <hr/> <p>Check the inlet and outlet Sections and the distances from setting equipment and pipe bends. Refer to Section 3.1 Installation conditions.</p> <hr/> <p>Check the distances from internal piping components such as pressure and temperature measuring points. Refer to Section 3.4 Installation for external pressure and temperature measurement.</p> <hr/> <p>Check whether valves are installed in the piping upstream of the sensor. Valves can disrupt the flow profile of the measuring medium and therefore impair the measurement. Valves can cause a hissing noise and impair the measurement. Refer to Section 3.5 Installation of setting equipment.</p>
	Installation	
	Outgassing of measuring media and cavitation	<p>Check whether there is sufficient back pressure downstream of the device to prevent cavitation.</p> <hr/> <p>For test purposes, increase the measuring medium pressure.</p> <hr/> <p>Pressure variations in measuring media at high pressures and temperatures can result in outgassing. A typical example is a pressure variation from a high to a low pressure through a valve.</p>
	Pulsating measuring media	<p>Pumps can cause hydraulic oscillations of the measuring medium in the piping. The frequency of this oscillations can be within the range of measuring frequency and thus have an effect on the measuring accuracy. Take appropriate measures to suppress hydraulic oscillations in the measuring medium.</p> <hr/> <p>When selecting the nominal diameter and device type of piston pumps, ensure that the pump frequency is below the minimum measuring frequency of the sensor.</p>
Incorrect flow measurement when there is a flow through the piping	Transmitter	<p>Determine the sensor frequency in the 'Diagnostics/Sensor Freq' menu. The frequency must correspond with the requirements set out in the measuring range tables. Refer to Measuring range tables in Section 10 Appendix. If the sensor frequency seems plausible, check the configuration of the transmitter and the electrical connection.</p> <hr/> <p>Check the function of the outputs in the 'Diagnostics/Simulation Mode' menu.</p> <hr/> <p>Check the configuration of the outputs in the 'Input/Output' menu.</p>

Malfunctions without error messages (contd.)

Failure	Corrective action	
The flowmeter measures a flow rate even though there is no flow through the piping.	General	See instructions in Section 5.12 Zero point balance under operating conditions and Section x.xx Sensor.
	Sensor	Check the meter tube gaskets. Even very small leaks can cause a hissing noise and impair the measurement. In the event of low flow rates in relation to the nominal diameter, this results in excessively high flow rates being measured. Hardly any errors occur with higher flow rates. If necessary, tighten the flange screws or replace the gaskets.
	Application	For test purposes, check the response of the device to changes in the flow.
	Installation	Check the seal integrity of closed valves.
		Valves can cause a hissing noise and impair the measurement.
	Pulsating measuring media	Pumps can cause hydraulic oscillations of the measuring medium in the piping. The frequency of this oscillations can be within the range of measuring frequency and thus have an effect on the measuring accuracy. Take appropriate measures to suppress hydraulic oscillations in the measuring medium.
		In long lengths of piping, temperature changes and pressure fluctuations can cause movement in the measuring medium, which is then interpreted as flow.
Transmitter	Determine the sensor frequency in the 'Diagnostics/Sensor Freq' menu. The frequency must correspond with the requirements set out in the measuring range tables. Refer to Measuring range tables in Section 10 Appendix. If the sensor frequency seems plausible, check the configuration of the transmitter and the electrical connection.	
	Check the function of the outputs in the 'Diagnostics/Simulation Mode' menu.	
	Check the configuration of the outputs in the 'Input/Output' menu.	

8. Repair

Repair and maintenance activities may only be performed by authorised customer service personnel. When replacing or repairing individual components, use original spare parts.

8.1 Replacing the transmitter, downloading system data

The sensor is equipped with storage capacity — known as the SensorMemory — in which the sensor calibration data and transmitter settings are saved.

In case of a replacement of components, these system data must be loaded into the new component. Loading of system data is controlled by the DIP switches on the communication board.

See Section 4.9.3 **DIP switch on the HART® communication board** or Section 4.9.5 **DIP switch on the Modbus communication board**.

Note

Depending on the model version (HART®/Modbus®), the positions and designations of the DIP switches may differ.

**After you replace the complete transmitter or the communication board:
The system data must be transferred from the sensor to the transmitter.**

- 1 Switch off the power supply.
- 2 Set DIP switch SW 1.2 (HART)/SW 1.1 (Modbus) to 'ON'.
- 3 Switch on the power supply.
- 4 Wait at least 60 seconds and then switch off the power supply.
- 5 Set DIP switch SW 1.2 (HART)/SW 1.1 (Modbus) to 'OFF'.
- 6 Switch on the power supply.

The system data has now been transferred from the sensor to the transmitter.

After you replace the sensor or the sensor board:

The system data must be transferred from the transmitter to the sensor.

- 1 Switch off the power supply.
- 2 Set DIP switch SW 1.2 (HART)/SW 1.1 (Modbus) to 'ON'.
- 3 Set DIP switch SW 1.3 (HART)/SW 1.2 (Modbus) to 'ON'.
- 4 Switch on the power supply.
- 5 Wait at least 60 seconds and then switch off the power supply.
- 6 Set DIP switch SW 1.2 (HART)/SW 1.1 (Modbus) to 'OFF'.
- 7 Set DIP switch SW 1.3 (HART)/SW 1.2 (Modbus) to 'OFF'.
- 8 Switch on the power supply.

The system data has now been transferred from the transmitter to the sensor.

Note: Check the device parameterisation before restarting the process!

8.2 Removal from the line



Warning!

Risk of injury due to process conditions.

The process conditions, for example high pressures and temperatures, toxic and aggressive measuring media, can give rise to hazards when dismantling the device.

- If necessary, wear suited personal protective equipment during disassembly.
- Before disassembly, make sure that the process conditions do not pose any safety risks.
- Depressurise and empty the device/piping, allow to cool and purge if necessary.

Bear the following points in mind when removing the device from the line:

- Switch off the power supply.
- Disconnect electrical connections.
- Allow the device/piping to cool and depressurise and empty. Collect any escaping medium and dispose of it in accordance with environmental guidelines.
- Use suitable tools to remove the device from the line, taking the weight of the device into consideration.
- If the device is to be used at another location, the device should preferably be packaged in its original packing so that it cannot be damaged.
- Observe the notices in Section **1.15 Returning products**.

9. Spares

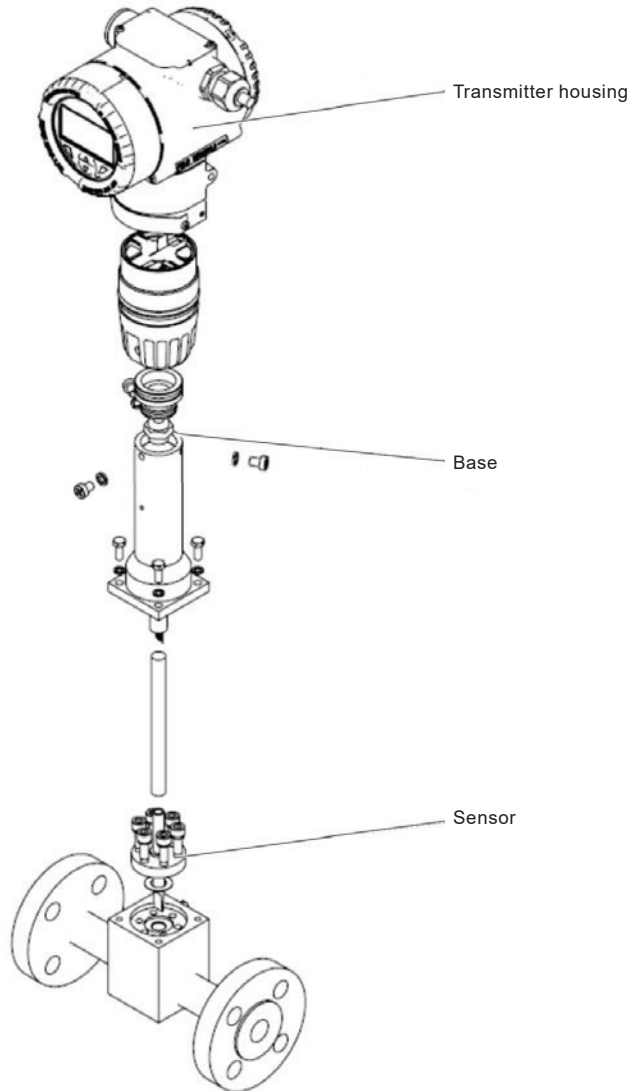

Fig. 44 Overview

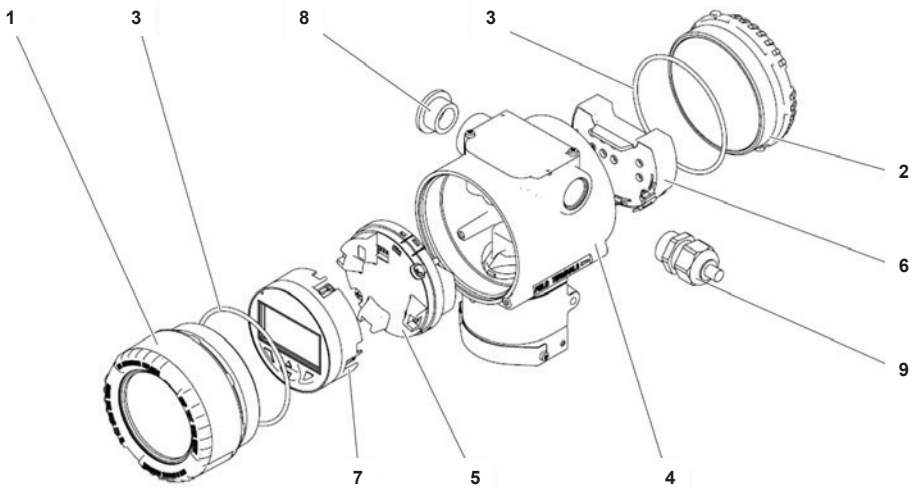

Fig. 45 Transmitter housing, integral mount

Only the items highlighted in bold, in the following table, are available as spare parts for the transmitter housing assembly.

No.	Description	Part Number
1	Cover with sight glass	
2	Blind cover	
3	O-ring	
4	Housing module	
	Communication boards VLM30-S HART pre- programmed	3KXF065100U0100A
5	Communication boards VLM30-S Modbus pre- programmed	3KXF065280U0100A
	Communication boards VLM30-E HART pre- programmed	3KQZ207044U0200A
6	Terminal block	
7	HMI (Display type L1)	AU3048B
8	Sealing plug (not supplied)	
9	Cable gland (not supplied)	

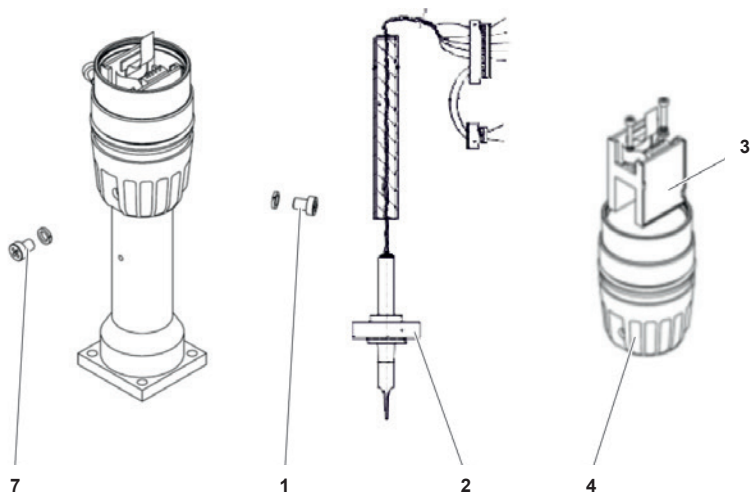

Fig. 46 Complete Base

Only the items highlighted in bold, in the following table, are available as spare parts for the base assembly.

No.	Description	Part Number
1	Screw M6 x 8 & spring washer 6.0 stainless steel	
Sensor std temp range -55 to 280 °C (-67 to 536 °F)	PT Sensor O-Ring groove 1.4571 6xM6 Std Ex-i	D693B082U01
	PT Sensor Flat sealing 1.4571 6xM6 Std Ex-i	D693B082U02
2		
Sensor high temp range -55 to 350 °C (-67 to 662 °F)	New HT piezo-sensor 1.4571 exi	3KXF065386U0100
3	Front-end board PCBA	
4	Front-End board (adapter housings) pre-programmed	3KXS360005L0002

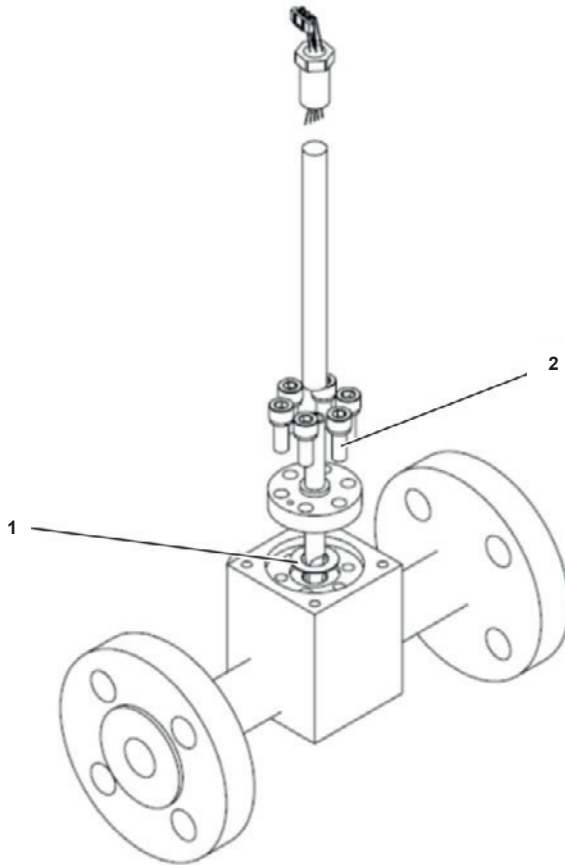

Fig. 47 Sensor

Only the following spare parts are available for the sensor assembly

	No.	Description	Part Number
Sensor std temp range -55 to 280 °C (-67 to 536 °F)	1	0-RING 10,77 X 2,62 PTFE (PT950)	D101C001U01
	2	Washer NOVAPH.SSTC 20X10X1	D333C126U01
Sensor high temp range -55 to 350 °C (-67 to 662 °F)	1	ZYL.SCHR.M.INSKT.M6x16 DIN912 A4-70-3.1B	D009J112AU26
	2	Washer NOVAPH.SSTC 20X10X1	D333C126U01

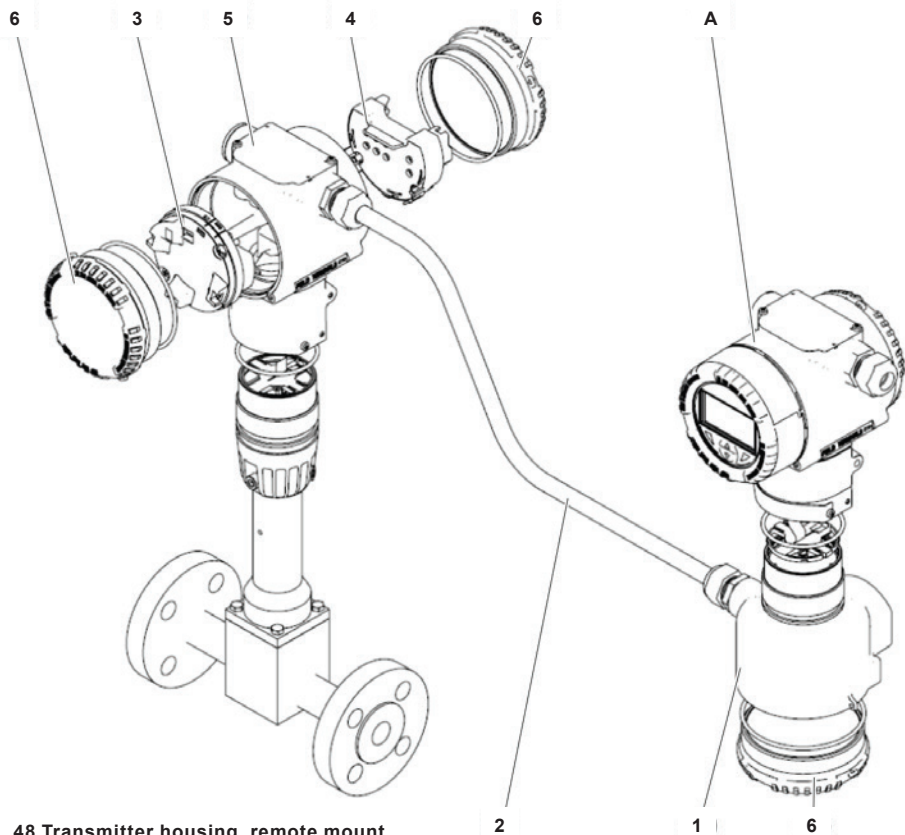

Fig. 48 Transmitter housing, remote mount

Only the items highlighted in bold, in the following table, are available as spare parts for the remote mount transmitter assembly.

No.	Description	Part Number
A	See Fig. 45 Transmitter housing, integral mount	
1	Housing module remote transmitter	
2	Signal cable, 20 m (66 ft)	3KXF065062U0400
3	Remote terminal board	
4	Terminal block, 9 terminals, for remote terminal box	
5	Housing module	
6	Blind cover and O-ring	

10. Appendix

10.1 Measuring range tables

Flow measurement for liquids

Nominal diameter	Minimum Reynolds number		QmaxDN ³		Frequency for Qmax ⁴
	Re1 ¹	Re2 ²	[m ³ /h]	[Usgpm]	[Hz, ±5%]
DN25 (1")	13100	20000	18	79	247
DN40 (1½")	15300	20000	48	211	193
DN50 (2")	15100	20000	75	330	155
DN80 (3")	44000	44000	170	749	101
DN100 (4")	36400	36400	270	1189	73
DN150 (6")	58000	58000	630	2774	51
DN200 (8")	128000	128000	1100	4844	40
DN250 (10")	100000	100000	1800	7926	33
DN300 (12")	160000	160000	2600	11449	28

Flow measurement of gases and steam

Nominal diameter	Flange	Minimum Reynolds number			Q _{max} DN ³	Frequency for Q _{max} ⁴
		Re1 ¹	Re2 ²	[m ³ /h]	[Us/gpm]	[Hz, ±5%]
DN25 (1")	DIN	6600	10000	150	88	2040
	ASME			130	76	2960
DN40 (1½")	DIN	6750	10000	390	230	1580
	ASME			390	230	2240
DN50 (2")	DIN	9950	20000	630	371	1310
	ASME			630	371	1720
DN80 (3")	DIN	1300	20000	1380	812	820
	ASME			1380	812	1120
DN100 (4")	DIN	16800	20000	2400	1413	640
	ASME			2400	1413	850
DN150 (6")	DIN	26500	27000	5400	3178	430
	ASME			5400	3178	540
DN200 (8")	DIN	27600	28000	9600	5650	350
	ASME			9600	5650	420
DN250 (10")	DIN	41000	41000	16300	9594	290
	ASME			16300	9594	320
DN300 (12")	DIN	48000	48000	23500	13832	260
	ASME			23500	13832	270

- 1 Minimum Reynolds number from which the function takes effect. For accurate dimensioning of the flowmeter, please use the Spirax Sarco sizing software.
- 2 Minimum Reynolds number from which the specified accuracy is achieved. Below this value, the measuring error is 0.5% of Q_{max}.
- 3 Medium velocity approx. 90 m/s (295 ft/s).
- 4 For information only, precise values can be found in the test log delivered with the device.

Spirax Sarco Ltd
Runnings Road
Cheltenham
GL51 9NQ
United Kingdom

www.spiraxsarco.com

VLM30 In-Line Vortex Flowmeter

spirax
/sarco