



**6600 series HEP Sensilevel  
float operated level controls  
with horizontal carbon steel chamber**

Installation and Maintenance Instructions

---

---

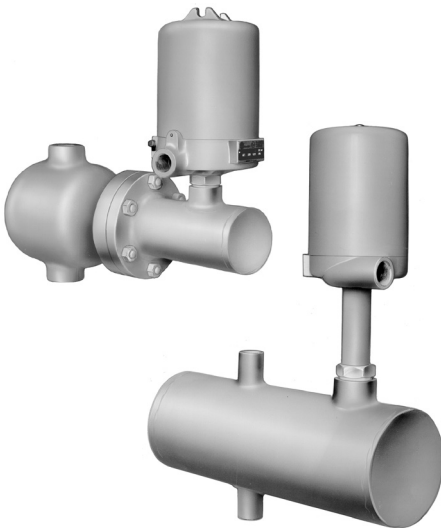

1. Safety information
2. General product information
3. Installation and Maintenance
4. Accessories
5. Spare parts
6. Maintenance
7. Trouble shooting
8. Spare parts
9. ATEX Conformity



---

# 1. Safety information

---

Asafe operation of SENSILEVEL products is assured when they are properly installed, commissioned, used and maintained by qualified personnel according to the operation instructions (see section 11 of present instruction paper). Compliance with installation and safety general instructions must also be observed during piping and plant erection together to an appropriate use of equipment and facilities for safety.

**Note: products supplied by Spirax Sarco are classified as components and, in general, they aren't subjected to the European Machinery Directive 2006/42/EC.**

## 1.1 Type of application

The suitability of Sensilevel has to be verified for the specific usage and application according to product tag and technical specifications and to installation and maintenance instructions. The products of the below indicated list comply with the requirements of the European Directive 2014/68/EU (Pressure Equipment Directive - PED) and are CE marked. They pertain to the following categories of the Pressure Equipment Directive.

Product	Gas / Liquid Group 1 & 2
6605	4
6606	4
6608	4

- I) Products have been specifically designed for hazardous and not hazardous fluids that are included in Group 1 and 2 of the above mentioned European Directive.
- II) Verify suitability of material and the minimum and maximum values of pressure and temperature. If the maximum operating limit conditions of the product are lower than those of the system where it has to be used or if an improper operation of the product might cause a dangerous excess of pressure and temperature, make sure to include in the system a safety device to prevent limits overcoming.
- III) Determine the correct position of the installation and the flow direction of the fluid.
- IV) Our products cannot cope with external stress induced by the system in which they operate. The installer is responsible of stress analysis and of adequate precautions to be taken in order to minimize the external stress.
- V) Remove protective covers from all connections prior to installation.

## 1.2 Accessibility

Ensure safe access and, if the case, a safe and properly protected platform before working on the product. Use suitable lifting mechanisms as necessary.

## 1.3 Lighting

Ensure adequate lighting, particularly where detailed or intricate work is required.

## 1.4 Hazardous gases or liquids in the pipeline

Consider the present or previous content of the pipeline paying attention to inflammable materials, substances dangerous to health and to extremes of temperature.

## 1.5 Dangerous environment

Take account of areas at risk of explosion, lack of oxygen (e.g. tanks or pits), dangerous gases, temperature extremes, hot surfaces, fire hazard (e.g. during welding), excessive noise, moving machinery.

These products comply with the requirements of the European Directive 2014/34/EU (ATEX) for the use of equipments in potentially explosive atmospheres.

In a classified area do not access the housing when powered and do not use tools that could cause sparks.

---

## 1.6 System

According to European Community laws on Health, Safety and Environmental Protection, upon returning products for their testing and/or repairs to Spirax Sarco, customers and distributors are reminded that they must supply the necessary information on hazards and precautions to be taken with regard to the presence of contaminated product residues or instrument damage which may present a health and/or environmental safety hazard. Information must be supplied in writing and include instructions for any substance classified as hazardous.

## 1.7 Pressure

Ensure that all parts exposed to pressure are isolated or adequately vented to atmospheric pressure. Consider double isolation (double block and venting) and blocking or labelling of closed valves. Do not assume a system is de-pressurized even when the pressure gauge reads zero.

## 1.8 Temperature

To avoid the risk of burns, wait until temperature has normalized after isolation.

## 1.9 Tools and consumables

Before starting a work, ensure the availability of appropriate tools and/or consumables. Use Spirax Sarco replacement parts only.

## 1.10 Protective clothing

Consider whether you and/or other personnel need protective clothing, against for example chemical products, high or low temperatures, noise, falling objects and hazards to eyes and face.

## 1.11 Permit of work

All works must be carried out or supervised by a competent staff, properly trained on product operation and maintenance. Should a formal authorization to work be required, this must be respected. Otherwise, it is recommended that a manager is kept informed on work progress and, if necessary, that an assistant with safety main responsibility is nominated. It is advisable to affix an hazard warning poster.

## 1.12 Material handling

The manual handling of large dimension and/or heavy material can cause risk of injury. Lifting, pushing, pulling, holding up and transportation of a load by strength of arms could damage the back. It is recommended to evaluate the risks by considering the assignment, the individual, the load and the environment and to use an appropriate material handling method.

## 1.13 Other risks

During normal operation the product surface could be very hot. The surface temperature of some products operating at limit conditions can reach a value of 200 °C. Several products do not provide auto-drainage. Take it in account for their disassembly or removal from the plant.

## 1.14 Freezing

The non auto-drainage products have to be protected from damage caused by freeze where they are exposed to temperatures under freezing point.

## 1.15 Disposal

Unless otherwise indicated in the instructions manuals, this product is recycleable. Therefore, provided appropriate precautions will be taken, there is no potential ecological risk after its disposal.

---

## 1.16 Returning products

According to European Community laws on Health, Safety and Environmental Protection, upon returning products for their testing and/or repairs to Spirax Sarco, customers and distributors are reminded that they must supply the necessary information on hazards and precautions to be taken with regard to the presence of contaminated product residues or instrument damage which may present a health and/or environmental safety hazard. Information must be supplied in writing and include instructions for any substance classified as hazardous.

## 1.17 Working safely with cast iron products on steam

Cast iron products are commonly found on steam and condensate systems. If installed correctly using good steam engineering practices, it is perfectly safe. However, because of its mechanical properties, it is less forgiving compared to other materials such as SG iron or carbon steel. The following are the good engineering practices required to prevent waterhammer and ensure safe working conditions on a steam system.

### Safe Handling

Cast Iron is a brittle material. If the product is dropped during installation and there is any risk of damage the product should not be used unless it is fully inspected and pressure tested by the manufacturer.

Please remove label before commissioning

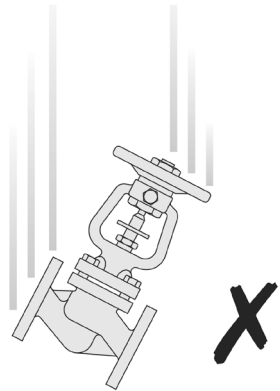

### Prevention of water hammer

Steam trapping on steam mains:

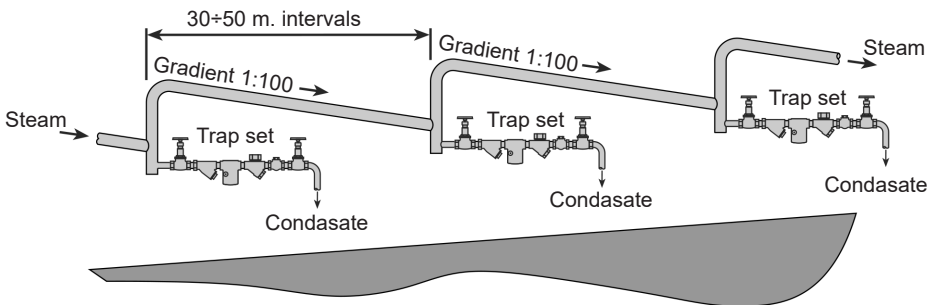

## Steam Mains - Do's (✓) and Dont's (X):

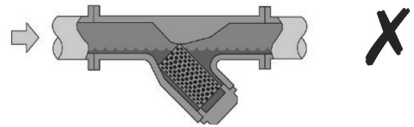
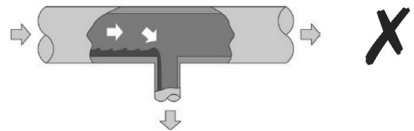
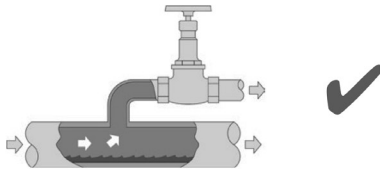
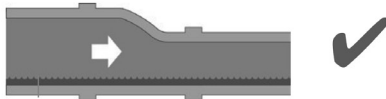
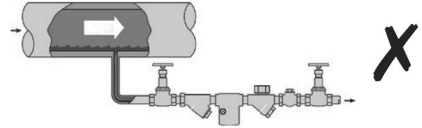
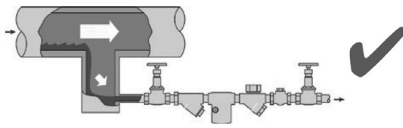

## Prevention of tensile stressing

Pipe misalignment:

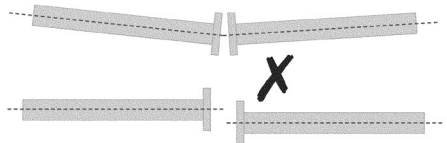
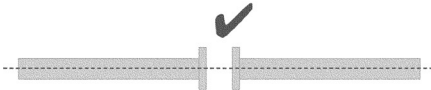

## Installing products or re-assembling after maintenance:



Do not over tighten.  
Use correct torque figures.

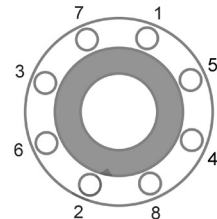
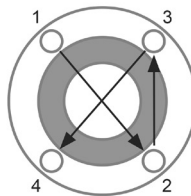

Flange bolts should be gradually tightened across diameters to ensure even load and alignment.

## Thermal expansion:

Examples showing the use of expansion bellows. It is highly recommended that expert advice is sought from the bellows manufacturer.

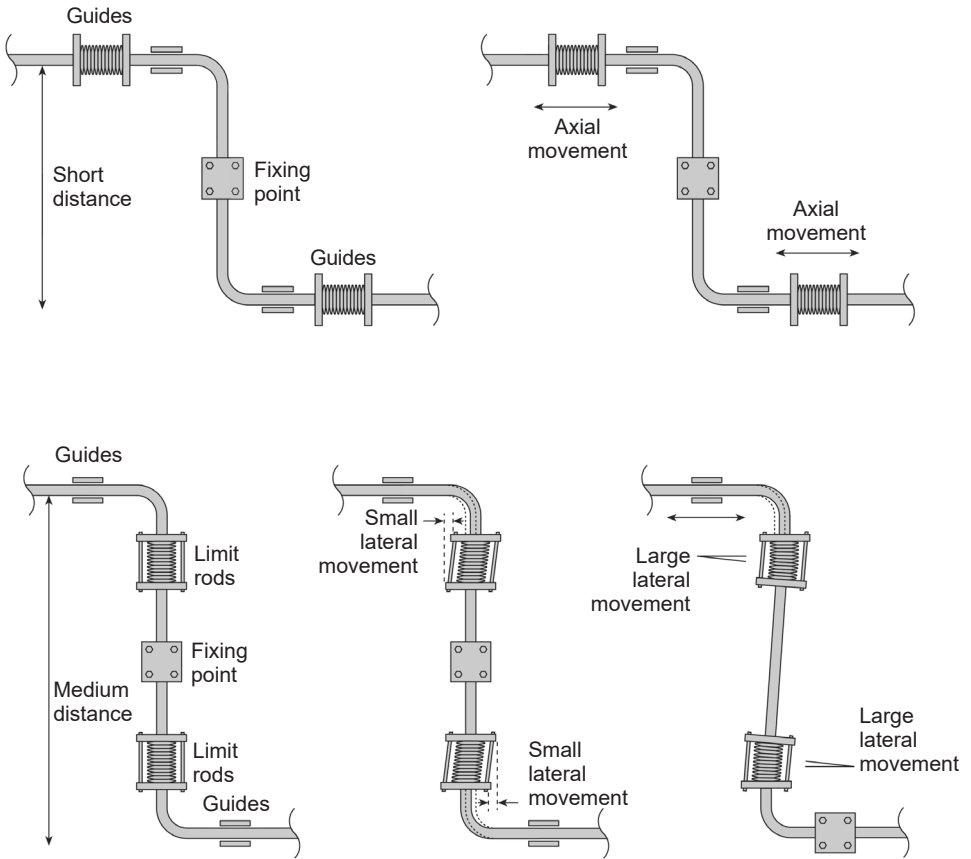

## 2. General product information

### 2.1 6600 series HEP Sensilevel float operated level controls with horizontal carbon steel chamber

This product is to be considered an accessory under pressure operating as a safety device and may be used with both Group 1 and 2 fluids. It has been designed, constructed and inspected according to ASME VIII Category "E" and it is in accordance with provisions demanded from the European Directives 2014/68/EU (PED) and 2014/34/EU (ATEX).

### 2.2 Environmental conditions

**Temperature:** from -10°C to +60°C in non-explosive atmosphere.

### 2.3 Identification plate

Each product is supplied with an identification plate fixed to its body. It indicates all specific data such as model, serial number, product category, year of construction, weight, volume, test pressure, project conditions, fluid group, etc.

		<b>spirax/sarco</b>		MOD. Model	
				N° FABBRICA Serial nr.	
		CAT.		CONTROLLO DI LIVELLO SENSILEVEL	
		GRUPPO FLUIDO		Liquid level control	
PESO Weight	kg	GRUPPO FLUIDO Fluid group	Volt	IP	
VOLUME Volume		LITRI liters	Amp.	ALIM. Supply	bar/g
PRESSIONE DI PROVA Test pressure		bar/g	Hz	Tmh	°C
CONDIZIONI DI PROGETTO Design condition		bar/g/°C			bar/g/°C
				ANNO Year	
Spirax-Sarco s.r.l. - Via per Cinisello, 18 - 20834 - Nova Milanese (MB) Tel. +39-0362-49171 - Fax +39-0362-4917310					

### 2.4 Dimensions

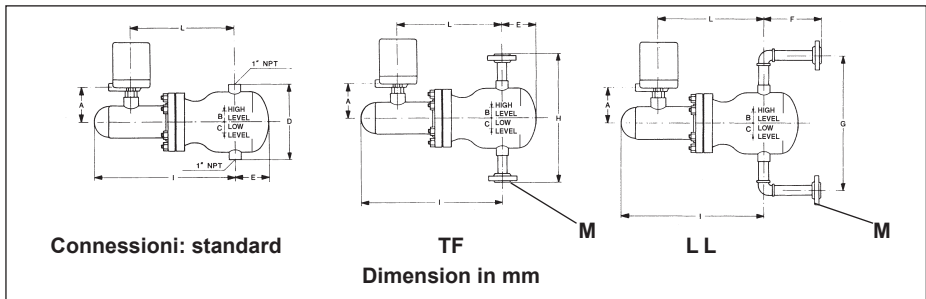

Model	A (2)	D	E	F	G	H	I	L	M (1")
<b>6605</b>	108	230	146	150	356	350	450	335	ANSI 300 RF
<b>6606</b>	108	230	146	150	356	350	450	335	ANSI 600 RF

- Notes:** (1) These values are valid for standard products, with S.W. or B.W. type connections, in carbon steel for usage with non-corrosive liquids or with water and steam in boiler applications. For bodies with flanged connections (standard 1" ANSI 300 RF or 1" ANSI 600 RF) the maximum pressure is determined by the rating of the same flanges.
- (2) When process temperatures are greater than the maximum allowed temperatures for each type of switch (see spec. 7A.100) a cooling extension between body and housing is required. Thus dimension A increases of 100 mm.



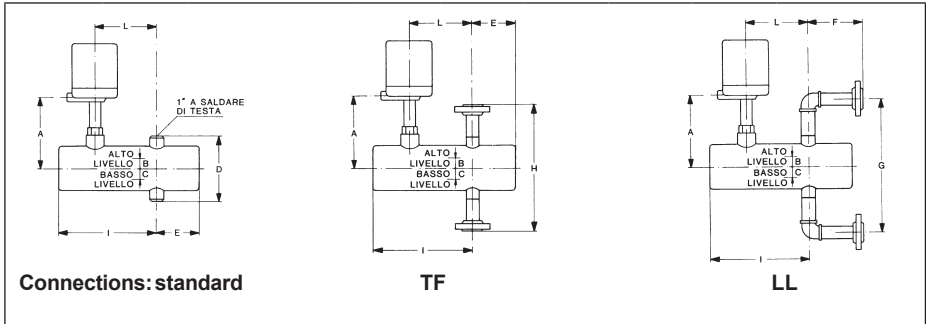

Model	Dimensioni di installazione (mm)								
	A	D	E	F	G	H	I	L	M (1")
6608	235	200	178	240	356	350	292	185	ANSI 600 RF

**Note:** (1) These values are valid for standard products, with S.W. or B.W. type connections, in carbon steel for usage with non-corrosive liquids or with water and steam in boiler applications.  
For bodies with flanged connections (standard 1" ANSI 600 RF) the maximum pressure is determined by the rating of the same flanges.

## 2.5 Switching levels (mm)

Model	Minimum specific gravity (kg/dm <sup>3</sup> )		Maximum pressure (bar) (1)		Switching levels (mm)	
	Mechanism Type 1, 2, 3	Mechanism Type 4 & 5	40°C	400°C	B	C
6605	0,40	0,44	50	42	10	10
6606	0,40	0,44	80	45	10	10
6608	0,65	-	100	87	10	10

**Note:** (1) Note: (1) These values are valid for standard products, with S.W. or B.W. type connections, in la pressione massima è determinata dal rating delle flange stesse. carbon steel for usage with non-corrosive liquids or with water and steam in boiler applications.  
For bodies with flanged connections (standard 1" ANSI 600 RF) the maximum pressure is determined by the rating of the same flanges.

## 2.6 Electrical connections

Provide connections to switch mechanisms according to wiring diagrams shown in fig.3. In order to access the switch mechanism, remove the cover of the housing by unscrewing the top screw on the standard housing (Fig. 2a). In case of an explosion-proof housing, loosen the cover locking screw and unscrew the cover itself counterclockwise (Fig. 2b).

The base of the housing has a threaded connection. With exception of explosion-proof type 4, the housing can be rotated through 360° by loosening the screw on the lower part. The wires have to pass through the threaded connection, then in the dedicated space between the base itself and the plate under the switch mechanism, and then connected to the terminal board using appropriate wire terminals.

Wires in excess have to be cut to avoid interference with the switch mechanism or housing. Afterwards the threaded connection must be sealed to assure safety and protection of the housing. Check the coupling between base and cover and ensure that the seal gasket, if used depending on the protection level required, is correctly mounted before re-closing the housing.

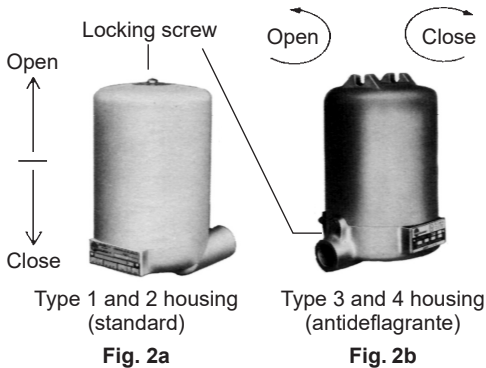

Contact status as function level	Closed contact	Open contact
Increasing level	2-3 and 5-6	1-2 and 4-5
Decreasing level	1-2 and 4-5	2-3 and 5-6

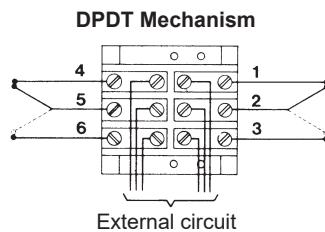
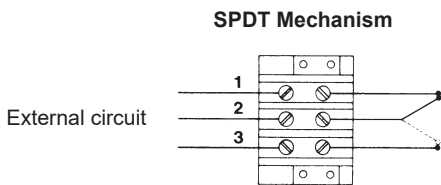
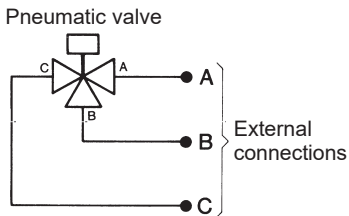

Fig. 3 - Wiring diagram of switch mechanism

## 2.7 Pneumatic connections (for pneumatic switches)

In order to obtain the required function from the pneumatic switch (3 way valve, 2 way valve, selector, switch) the instrument has to be connected to the pneumatic circuit using the below indicated table and diagram. Pipes must be connected to the 1/4" NPT connections on the base of the housing. They are identified with A, B and C and already connected within the housing to the 3 way pneumatic switch.



### Contact status as a functional level

Connection	2 way N.A.	2 way N.C.	3 way N.A.	3 way N.C.
A	plugged	inlet	vented	inlet
B	inlet	plugged	inlet	vented
C	outlet	outlet	outlet	outlet

Fig. 4 - Pneumatic switch diagram

### Switching levels

- HIGH LEVEL: liquid level for which the switch mechanism is activated when the level itself is increasing (B).
- LOW LEVEL: liquid level for which the switch mechanism is activated when the level itself is decreasing (C).
- DIFFERENTIAL: difference between high and low level.

The instrument is normally calibrated in the factory to the minimum value of differential (there must be a small amount of clearance between the pair of nuts holding the magnetic piston). The differential value can not be increased.

---

## 3. Installation

---

### 3.1 Transport

The equipment is packed in palletized carton boxes, in which spacers are inserted to avoid shaking during transport. The palletized support is suitable for movement with fork lift trucks. The gross weight is externally indicated on the container.

### 3.2 Mounting on plant

Mount the instrument on the plant using the provided connections (flanged or threaded), so that the housing of the switch mechanism faces upwards and its axis is vertical (a maximum 3° misalignment is acceptable). Connection pipes to process must be straight-line with full flow through them. Their length have to be kept at a minimum value to ensure correct fluid circulation.

Appropriate support system will be used to avoid unwanted stress to the chamber and its connections. Level controls working with liquids which might leave deposits must include T or cross type fittings to allow periodic pipeline cleaning. A drain or blowdown valve (preferably with a straight line flow) will be useful to clean the float chamber and the connection pipes to the process. During their operation all on/off valves must be completely open with a full flow through them to avoid improper level switching.

Allow a free space of at least 200 mm above the housing to permit its removal. Switching levels B and C are influenced by the specific gravity of the controlled liquid and are reported in the table of paragraph 2.5.

### 3.3 Grounding

Sensilevel must be electrically grounded using the proper terminals identified with a specific tag.

### 3.4 End of operation

The product may be disposed only near by authorized sites. The materials used and the reduced volumes make the end of operation almost irrelevant. A complete emptying of the chamber is recommended only when an external storage at low temperature is expected for a long period.

## 4. Switch mechanism replacement

### A - Electrical switch mechanism

Turn off the power, remove the cover of the housing and proceed as follows:

- 1 - Remove external connections from the terminal board and record the position of each wire. Identify also the position of the mechanism on the non-magnetic pocket.
- 2 - Loosen the 2 fixing screws "A" of the plate (see Fig. 6 - Electrical type); take out then the switch mechanism from the non-magnetic pocket.
- 3 - Replace the switch mechanism and reassemble the unit by performing above actions 2 and 1 reversely.
- 4 - Manually check the lever of the magnet holder and make sure it moves freely and that the switch is correctly operated.
- 5 - Reconnect the electrical wires ensuring that they do not interfere with the movement of the mechanism or with the housing.

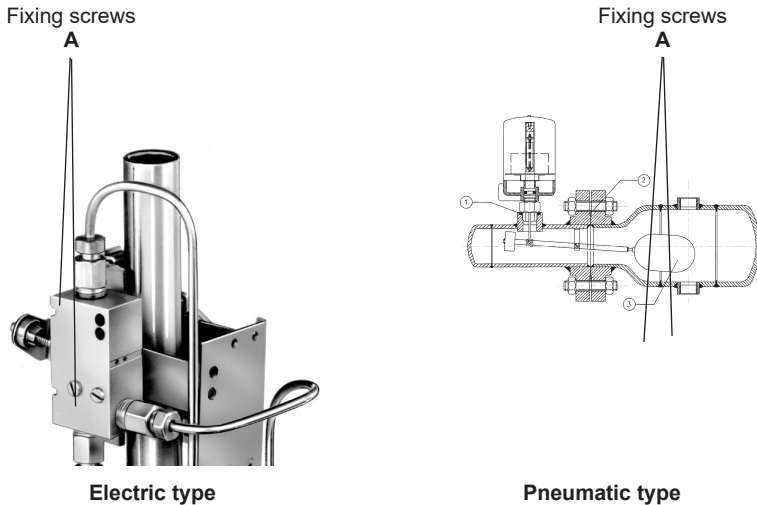

Fig. 6 - Switch mechanism

### B - Pneumatic switch mechanism

Close the feed line of the compressed air, remove the cover of the housing and proceed as follows:

- 1 - Remove the pipes of the valve and identify the position of the mechanism on the enclosing tube.
- 2 - Loosen the 2 fixing screws "A" of the mechanism (Fig. 6 - Pneumatic type) and take it out from the enclosing tube.
- 3 - Replace the switch mechanism and reassemble the unit by performing above actions 2 and 1 reversely.
- 4 - Manually check the lever of the magnet holder and make sure it moves freely and that the valve is correctly operated.
- 5 - Reconnect the pipes to the valve ensuring that they do not interfere with the movement of the mechanism or with the housing.

---

# 5. Switch replacement

---

## A - Electrical switch

- 1 - Remove switch wires from the terminal board.
- 2 - Remove the 2 fixing screws "D" (See fig. 7 - Electrical type) and then the switch.
- 3 - Replace the old switch with the new one and reassemble by performing above actions 2 and 1 reversely.
- 4 - Manually check the lever of the magnet holder ensuring that the switch opens and closes correctly. If necessary make adjustments with screw "C" (see fig. 7 - Electrical type).

## B - Pneumatic switch

- 1 - Remove pipes from the valve.
- 2 - Remove the 2 fixing screws "D" (fig.7 - Pneumatic type) and then the valve.
- 3 - Replace the old valve with the new one and reassemble by performing above actions 2 and 1 reversely.
- 4 - Manually check the lever of the magnet holder ensuring that the switch opens and closes correctly. If necessary make adjustments with screw "C" (see fig. 7 - Pneumatic type).

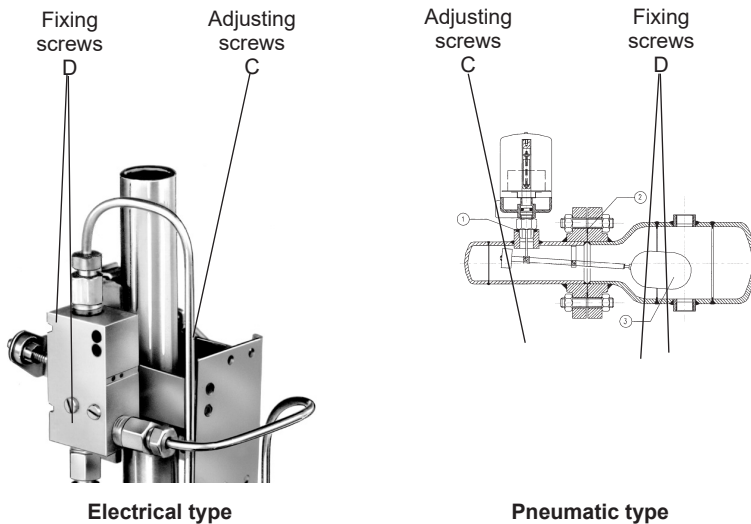

Fig. 7 - Electrical and pneumatic switches

---

## 6. Maintenance

---

Periodical inspections are necessary to guarantee a complete efficiency of the instrument. A regular maintenance program starting from its installation is recommended. The suggested precautions are important to obtain the best operating conditions of the level control.

### **A - Keep Sensilevel clean**

To avoid damage caused by humidity and dust, leave the instrument without its housing only for the strictly necessary time.

Do not lubricate any component of the instrument.

### **B - Check switches monthly**

#### **1 - Connections**

Verify the integrity of all switch connections (electrical or pneumatic).

#### **2b - Microswitches**

Verify alignment between the adjusting screw "C" and the lever operating the microswitch (Fig. 7 - Electrical type). Check correct switching of the microswitch by manually operating the lever of the magnet holder.

#### **2c - Pneumatic switches**

Verify alignment between the adjusting screw "C" and the pushbutton controlling the valve (Fig. 7 - Pneumatic type). Check correct switching of the valve by manually operating the lever of the magnet holder.

These functionality checks of the switches must also be carried out when potentially damaging events such as short circuits, electrical discharges, or excess of pressure occur.

Avoid to leave in operation any faulty or incorrectly functioning instrument.

In case of parts replacement carefully follow the repair instructions supplied with the spare part.

Contact our central office or nearest sales point in case of doubt.

---

## 7 . Trouble shooting

---

Sensilevel level controls are designed for long lasting and for fault-free operation.

However, if a malfunction is suspected, the below indicated checks can be performed to diagnose any problem.

- 1 - Is the level control correctly installed? (See instructions at point 1 - Installation).
- 2 - Is the level control operating within the limits of liquid pressure, temperature and density indicated on the identification plate?
- 3 - Are the electrical or pneumatic connections intact? Is the instrument powered?
- 4 - Are the voltage and current or the control pressure applied to the switches within the limits established and reported on the plate?
- 5 - Do the switch connections comply with the supplied instructions and the general plant diagram?
- 6 - Is the equipment controlled by the instrument correctly connected and operating?
- 7 - Is the switch mechanism fixed to the non-magnetic pocket as in ex-factory position?
- 8 - Is the switch damaged?  
Check that it is not cracked and that its wire terminals and pipes are not corroded. If any physical damage is found, the switch must be replaced.
- 9 - Does the switch properly work when it is manually operated? Operate the lever of the magnet holder manually: it should not oppose any resistance. This manual movement will make the switch working. Verify the contact continuity with an appropriate tool.  
**Note:** ensure that the lever of the microswitch is not bended and that the adjusting screw is positioned in its centre.
- 10- Is the inside of the level control free from dirt and deposits?
  - a. Check that the non-magnetic pocket has no external dents (the pipe must not be bent).
  - b. Check that the inside of the pipe has no deposits and dirt or it is corroded.
  - c. Check that the magnetic piston and the stem are not corroded, incrustated or bent.
  - d. The adjusting nuts are individually positioned in the factory for each level control. Ensure that they have not been loosened and that their position allow the magnetic piston to move inside and outside of the magnetic field upon a level variation.
  - e. Ensure that the float is not perforated (i.e. it is floating) and without incrustations.
  - f. Inspect the body internally e the plant connections ensuring there are no deposits and incrustations.
- 11- Should the above described checks have not traced the problem, contact our central or local office.

## 8. Spare parts

Spare parts are available in kits as indicated in the table below. No other part that is not indicated can be supplied as spare.

### Available spare parts

Ref.	Description	Q.ty	Standard Spares	Model & Code	
				6605	6606
1	Pocket gasket	1	Pocket gasket	3.767.4925.002	3.767.4925.001
2	Float Assembly	1	Body gasket	3.764.4550.003	3.764.4550.001
3		1	Float		

### How to order spare parts

Place order for spare parts always using the description shown in the table and indicating the Sensilevel model.

**Example:** Float assembly for Sensilevel model 6605.

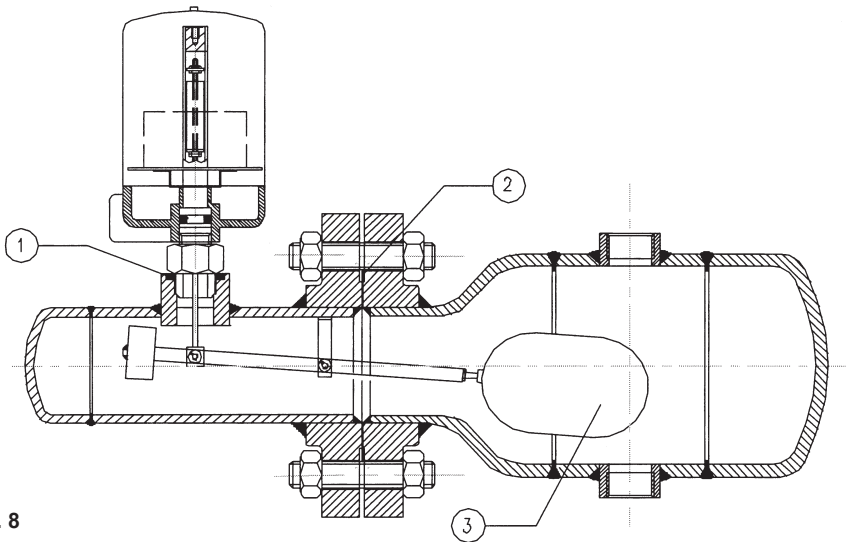

Fig. 8



# 9. ATEX Conformity

Here below are listed the name-plates of compliance for the standard products covered in this instruction; for all special versions derived from standard are supplied against a specific order, an "ad hoc" documentation will be issue by our Documentation and Test Departement.

Explosion-proof housing for usage in areas at risk of explosion. The instrument can be used with process liquids at an operating temperature not exceeding 85°C.

The electrical cable connections utilized must have the appropriate Atex certification. During connection check inside the housing that all wires have a minimum clearance distance of 3 mm from the housing wall.

Electrical characteristics
120 Vac / 15 Aac
380 Vac / 15 Aac
30 Vdc / 6 Adc
240 Vdc / 0,2 Adc
<b>Note:</b> The accessories utilized for cable connection must conform with Standards CENELEC EN 60079-0, EN 60079-1, EN 60079-11, EN 60079-26 e EN 60079-31.

<b>spirax/sarco</b>			HEP	0425 ATEX 002845-00
<b>CE</b>	0425		II 2GD	Ex d IIC T6 Gb Ex tb IIIC T 85°C Db IP66/67 II 1G
N° FABBRICA SERIAL NR. _____		IP		67
_____ V		_____ A		_____ Hz
Spirax-Sarco S.r.l. - Via per Cinisello, 18 - 20834 Nova Milanese (MB) - Italy Tel. +39-0362-49171 - Fax +39-0362-4917310				







<b>spirax/sarco</b>			HEP	0425 ATEX 002845-00
<b>CE</b>	0425		II 2GD	Ex d IIC T6 Gb Ex tb IIIC T 85°C Db IP66/67 II 1G
N° FABBRICA SERIAL NR. _____		IP		67
T <sub>a</sub> = -45 ÷ +60°C		_____ V		_____ A
_____ Hz				
Spirax-Sarco S.r.l. - Via per Cinisello, 18 - 20834 Nova Milanese (MB) - Italy Tel. +39-0362-49171 - Fax +39-0362-4917310				

Intrinsic safety explosion-proof housing for usage in areas at risk of explosion. The instrument can be used with process liquids at an operating temperature not exceeding 85°C.





The electrical cable connections utilized must have the appropriate Atex certification. During connection check inside the housing that all wires have a minimum clearance distance of 3 mm from the housing wall.

HEP series level switches in II 1G Ex ia or IIC T6 Ga execution must be protected with Associated Apparatus in II (1)G [Ex ia] IIC execution, with safety parameters  $U_0$  and  $I_0$  compatible with the values indicated in the certificate.

Electrical characteristics	
Ui:	30 V
Ii:	100 mA
Li ~	0
Ci ~	0
<b>Note:</b> The accessories utilized for cable connection must conform with Standards CENELEC EN 60079-0, EN 60079-1, EN 60079-11, EN 60079-26 e EN 60079-31.	

  0425		HEP	0425 ATEX 002845-00
		II 2GD	Ex d IIC T6 Gb Ex tb IIC T 85°C Db IP66/67
N° FABBRICA _____ SERIAL NR. _____		II 1G	Ex ia IIC T6 Ga
 _____ IP <input type="text" value="67"/> 			
<input type="text"/> V <input type="text"/> A <input type="text"/> Hz			
Spirax-Sarco S.r.l. - Via per Cinisello, 18 - 20834 Nova Milanese (MB) - Italy Tel. +39-0362-49171 - Fax +39-0362-4917310			



  0425		HEP	0425 ATEX 002845-00
		II 2GD	Ex d IIC T6 Gb Ex tb IIC T 85°C Db IP66/67
N° FABBRICA _____ SERIAL NR. _____		II 1G	Ex ia IIC T6 Ga
 _____ IP <input type="text" value="67"/> 			
T <sub>a</sub> <input type="text" value="-45 ÷ +60°C"/> <input type="text"/> V <input type="text"/> A <input type="text"/> Hz			
Spirax-Sarco S.r.l. - Via per Cinisello, 18 - 20834 Nova Milanese (MB) - Italy Tel. +39-0362-49171 - Fax +39-0362-4917310			

Explosion-proof housing for usage in areas at risk of explosion suitable for level control applications with flammable liquids, thanks to the interface design between **Zone 0** and the housing inside compliant to to EN 60079-26 regulation , and to the hermetic contacts use (avoiding ignition sources inside the housing in standard operating conditions)(**category 1/2G**). The instrument can be used with process liquids at an operating temperature not exceeding 85°C. The electrical cable connections utilized must have the appropriate Atex certification. During connection check inside the housing that all wires have a minimum clearance distance of 3 mm from the housing wall.

<b>Electrical characteristics</b>
120 Vac / 15 Aac
380 Vac / 15 Aac
30 Vdc / 6 Adc
240 Vdc / 0,2 Adc
<b>Note:</b> The accessories utilized for cable connection must conform with Standards CENELEC EN 60079-0, EN 60079-1, EN 60079-11, EN 60079-26 e EN 60079-31.

<b>spirax/sarco</b>		HEP	0425 ATEX 002845-00
<b>CE</b> 0425		II 1/2G Ex d IIC T6 Ga/Gb	
⊕	N° FABBRICA SERIAL NR. _____	IP	67 ⊕
	<input type="text"/> V	<input type="text"/> A	<input type="text"/> Hz
Spirax-Sarco S.r.l. - Via per Cinisello, 18 - 20834 Nova Milanese (MB) - Italy Tel. +39-0362-49171 - Fax +39-0362-4917310			



<b>spirax/sarco</b>		HEP	0425 ATEX 002845-00
<b>CE</b> 0425		II 1/2G Ex d IIC T6 Ga/Gb	
⊕	N° FABBRICA SERIAL NR. _____	IP	67 ⊕
T <sub>a</sub>	<input type="text"/> -45 ÷ +60°C	<input type="text"/> V	<input type="text"/> A <input type="text"/> Hz
Spirax-Sarco S.r.l. - Via per Cinisello, 18 - 20834 Nova Milanese (MB) - Italy Tel. +39-0362-49171 - Fax +39-0362-4917310			

---

## **SERVICE**

For technical support, please contact our local Sales Engineer or our Head Office directly:

**Spirax Sarco S.r.l.** - Technical Assistance

Via per Cinisello, 18 - 20834 Nova Milanese (MB) - Italy

Tel.: (+39) 0362 4917 257 - (+39) 0362 4917 211 - Fax: (+39) 0362 4917 315

E-mail: [support@it.spiraxsarco.com](mailto:support@it.spiraxsarco.com)

## **LOSS OF GUARANTEE**

**Total or partial disregard of above instructions involves loss of any rights to guarantee.**

**Spirax-Sarco S.r.l.** - Via per Cinisello, 18 - 20834 Nova Milanese (MB) - Tel.: 0362 49 17.1 - Fax: 0362 49 17 307