

## GKE ball float steam traps Installation and Maintenance Instructions

---

The PED Directive 97/23/EC is repealed and replaced by the new  
**PED Directive 2014/68/EU** with effect from 19 July 2016.



- 1. Safety information*
- 2. General product information*
- 3. Installation*
- 4. Commissioning*
- 5. Operation*
- 6. Maintenance*
- 7. Spare parts*



---

# ATTENZIONE

## Lavorare in sicurezza con apparecchiature in ghisa e vapore

### **Working safely with cast iron products on steam**

Informazioni di sicurezza supplementari - *Additional Informations for safety*

#### **Lavorare in sicurezza con prodotti in ghisa per linee vapore**

I prodotti di ghisa sono comunemente presenti in molti sistemi a vapore.

Se installati correttamente, in accordo alle migliori pratiche ingegneristiche, sono dispositivi totalmente sicuri.

Tuttavia la ghisa, a causa delle sue proprietà meccaniche, è meno malleabile di altri materiali come la ghisa sferoidale o l'acciaio al carbonio.

Di seguito sono indicate le migliori pratiche ingegneristiche necessarie per evitare i colpi d'ariete e garantire condizioni di lavoro sicure sui sistemi a vapore.

#### **Movimentazione in sicurezza**

La ghisa è un materiale fragile: in caso di caduta accidentale il prodotto in ghisa non è più utilizzabile. Per informazioni più dettagliate consultare il manuale d'istruzioni del prodotto.

Rimuovere la targhetta prima di effettuare la messa in servizio.

#### **Working safely with cast iron products on steam**

*Cast iron products are commonly found on steam and condensate systems.*

*If installed correctly using good steam engineering practices, it is perfectly safe.*

*However, because of its mechanical properties, it is less forgiving compared to other materials such as SG iron or carbon steel.*

*The following are the good engineering practices required to prevent waterhammer and ensure safe working conditions on a steam system.*

#### **Safe Handling**

*Cast Iron is a brittle material. If the product is dropped during installation and there is any risk of damage the product should not be used unless it is fully inspected and pressure tested by the manufacturer.*

*Please remove label before commissioning*

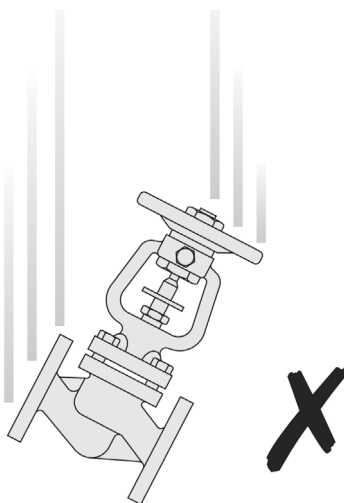

# Prevenzione dai colpi d'ariete - *Prevention of water hammer*

Scarico condensa nelle linee vapore - *Steam trapping on steam mains:*

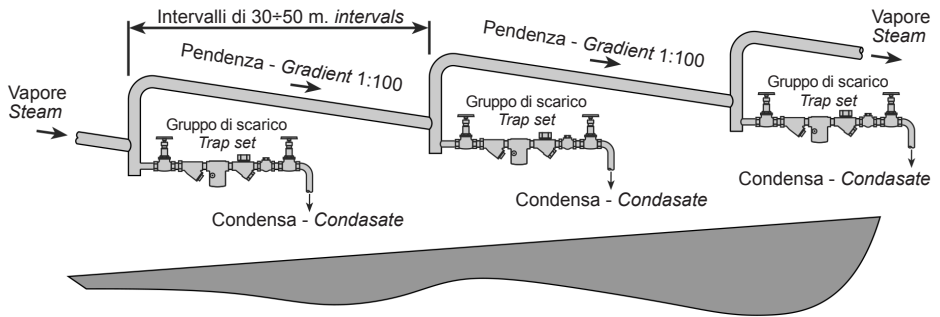

## Esempi di esecuzioni corrette (✓) ed errate (✗) sulle linee vapore: *Steam Mains - Do's and Don't's:*

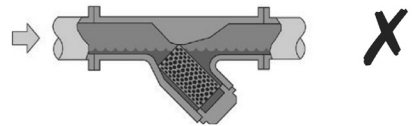
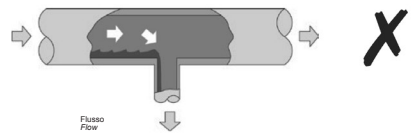
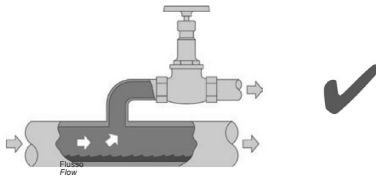
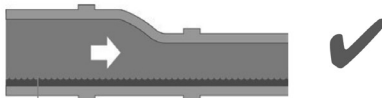
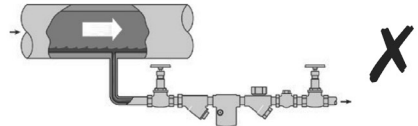
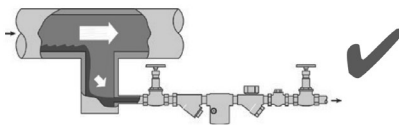

---

## Prevenzione delle sollecitazioni di trazione

### *Prevention of tensile stressing*

Evitare il disallineamento delle tubazioni - *Pipe misalignment*:

**Installazione dei prodotti o loro rimontaggio post-manutenzione:**  
*Installing products or re-assembling after maintenance:*

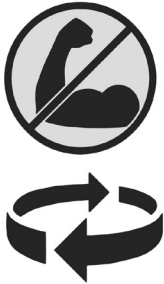

Evitare l'eccessivo serraggio.  
Utilizzare le coppie di serraggio raccomandate.

*Do not over tighten.  
Use correct torque figures.*

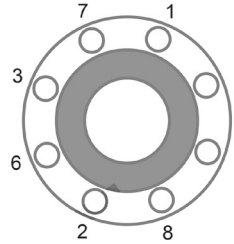
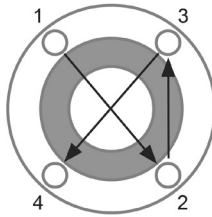

Per garantire l'uniformità del carico e dell'allineamento, i bulloni delle flange devono essere serrati in modo graduale e in sequenza, come indicato in figura.

*Flange bolts should be gradually tightened across diameters to ensure even load and alignment.*

## Dilatazioni termiche - *Thermal expansion:*

Gli esempi mostrano l'uso corretto dei compensatori di dilatazione. Si consiglia di richiedere una consulenza specialistica ai tecnici dell'azienda che produce i compensatori di dilatazione.

*Examples showing the use of expansion bellows. It is highly recommended that expert advise is sought from the bellows manufacturer.*

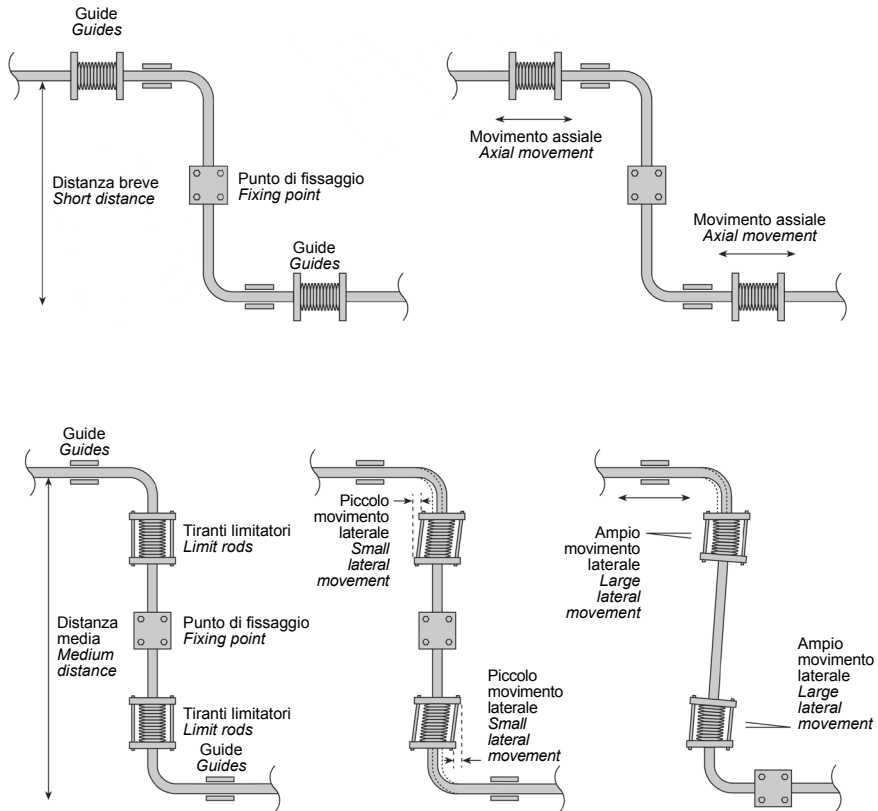

---

# 1. Safety information

---

Safe operation of these products can only be guaranteed if they are properly installed, commissioned, used and maintained by qualified personnel (see Section 1.11 on this document) in compliance with the operating instructions.

General installation and safety instructions for pipeline and plant construction, as well as the proper use of tools and safety equipment must also be complied with.

## 1.1 Intended use

Referring to the Installation and Maintenance Instructions, name-plate and Technical Information Sheet, check that the product is suitable for the intended use/application.

These products comply with the requirements of the European Pressure Equipment Directive 97/23/EC and carry the **CE** mark when so required. The products fall within the following Pressure Equipment Directive categories:

Product	Group 1 Gases	Group 2 Gases	Group 1 Liquids	Group 2 Liquids
GKE DN1½" - 2" / 40 - 50	-	1	-	SEP

- I) These products have been specifically designed for use on steam, air or condensate/water, which is in Group 2 of the above mentioned Pressure Equipment Directive. The products' use on other fluids may be possible but, if this is contemplated, Spirax Sarco should be contacted to confirm the suitability of the product for the application being considered.
- II) Check material suitability, pressure and temperature and their maximum and minimum values. If the maximum operating limits of the product are lower than those of the system in which it is being fitted, or if malfunction of the product could result in a dangerous overpressure or overtemperature occurrence, ensure a safety device is included in the system to prevent such over-limit situations.
- III) Determine the correct installation situation and direction of fluid flow.
- IV) Spirax Sarco products are not intended to withstand external stresses that may be induced by any system to which they are fitted. It is the responsibility of the installer to consider these stresses and take adequate precautions to minimise them.
- V) Remove protection covers from all connections before installation.

## 1.2 Access

Ensure safe access and if necessary a safe working platform (suitably guarded) before attempting to work on the product. Arrange suitable lifting gear if required.

## 1.3 Lighting

Ensure adequate lighting, particularly where detailed or intricate work is required.

## 1.4 Hazardous liquids or gases in the pipeline

Consider what is in the pipeline or what may have been in the pipeline at some previous time. Consider: flammable materials, substances hazardous to health, extremes of temperature.

## 1.5 Hazardous environment around the product

Consider: explosion risk areas, lack of oxygen (e.g. tanks, pits), dangerous gases, extremes of temperature, hot surfaces, fire hazard (e.g. during welding), excessive noise, moving machinery.

## 1.6 The system

Consider the effect on the complete system of the work proposed. Will any proposed action (e.g. closing isolation valves, electrical isolation) put any other part of the system or any personnel at risk? Dangers might include isolation of vents or protective devices or the rendering ineffective of controls or alarms. Ensure isolation valves are turned on and off in a gradual way to avoid system shocks.

---

## **1.7 Pressure systems**

Ensure that any pressure is isolated and safely vented to atmospheric pressure. Consider double isolation (double block and bleed) and the locking or labelling of closed valves. Do not assume that the system has depressurised even when the pressure gauge indicates zero.

## **1.8 Temperature**

Allow time for temperature to normalise after isolation to avoid danger of burns.

## **1.9 Tools and consumables**

Before starting work ensure that you have suitable tools and/or consumables available. Use only genuine Spirax Sarco replacement parts.

## **1.10 Protective clothing**

Consider whether you and/or others in the vicinity require any protective clothing to protect against the hazards of, for example, chemicals, high /low temperature, radiation, noise, falling objects, and dangers to eyes and face.

## **1.11 Permits to work**

All work must be carried out or be supervised by a suitably competent person. Installation and operating personnel should be trained in the correct use of the product according to the Installation and Maintenance Instructions. Where a formal 'permit to work' system is in force it must be complied with. Where there is no such system, it is recommended that a responsible person should know what work is going on and, where necessary, arrange to have an assistant whose primary responsibility is safety. Post 'warning notices' if necessary.

## **1.12 Handling**

Manual handling of large and/or heavy products may present a risk of injury. Lifting, pushing, pulling, carrying or supporting a load by bodily force can cause injury particularly to the back. You are advised to assess the risks taking into account the task, the individual, the load and the working environment and use the appropriate handling method depending on the circumstances of the work being done.

## **1.13 Residual hazards**

In normal use the external surface of the product may be very hot. If used at the maximum permitted operating conditions the surface temperature of some products may reach very high temperatures (200°C). Many products are not self-draining. Take due care when dismantling or removing the product from an installation (refer to 'Maintenance' instructions).

## **1.14 Freezing**

Provision must be made to protect products which are not self-draining against frost damage in environments where they may be exposed to temperatures below freezing point.

## **1.15 Safety information - Product specific**

See the specific details relating to the product in the following "Maintenance" section.

## **1.16 Disposal**

Unless otherwise stated in the Installation and Maintenance Instructions, this product is recyclable and no ecological hazard is anticipated with its disposal providing due care is taken.

## **1.17 Returning products**

Customers and stockists are reminded that under EC Health, Safety and Environment Law, when returning products to Spirax Sarco they must provide information on any hazards and the precautions to be taken due to contamination residues or mechanical damage which may present a health, safety or environmental risk. This information must be provided in writing including Health and Safety data sheets relating to any substances identified as hazardous or potentially hazardous.



## 2. General product information

### 2.1 General description

The GKE series float steam traps are manufactured with nodular iron body; internal components are made from stainless steel. They are suitable for use with saturated and superheated steam on process equipments and on medium / high consumption applications. Working is fully automatic also regarding air venting (bimetallic thermo element) while the condensate discharge has modulating characteristics. These traps are ideal for all process drainage applications as condensate is always removed efficiently and quickly over a wide range of fluctuating pressures and load conditions; they meet all the needs and demands of process automatic control systems. To facilitate the installation on the plant, the mounting connections can be easily positioned in four different way. For more demanding applications, higher pressure and temperature, see the similar GHE series manufactured with carbon or stainless steel body.

#### Standards

This product fully complies with the requirements of the European Pressure Equipment Directive 97/23/EC and carries the **CE** mark when so required.

#### Certification

This product is available with material certification to EN 10204 2.2 or EN 10204 3.1.

**Note:** all certification/inspection requirements must be stated at the time of order placement.

#### Sizes and pipe connections

DN 40 and DN 50 flanged EN 1092 PN25/40, standard

DN 40 and DN 50 flanged ANSI B 16.5 Class 150 and 300, on request

1½" and 2" screwed UNI-ISO 7/1 R<sub>p</sub> (gas), on request

### 2.2 Pressure/temperature limits (ISO 6552)

PMA - Maximum allowable pressure	25 bar g	@ 300°C
TMA - Maximum allowable temperature		300°C
Minimum allowable temperature		-10°C
PMO - Maximum operating pressure	21 bar g	@ 300°C
TMO - Maximum operating temperature		300°C
Minimum operating temperature, danger of freezing considered		0°C
ΔPMX - Maximum differential pressure	GKE 10	10 bar g
	GKE 21	21 bar g
Designed for a maximum cold hydraulic test pressure of		37.5 bar g

**Note:** maximum operating pressure can be limited by the rating chosen for the flanges.

### 2.3 Dimensions/weights (approximate) in mm and kg

DN	A	A1	B	C	D	E*	Weight	
							Scrd./SW	Flgd.
1½" - 40	320	324	280	120	300	480	25.0	30.0
2" - 50	320	324	280	120	300	480	25.0	32.0

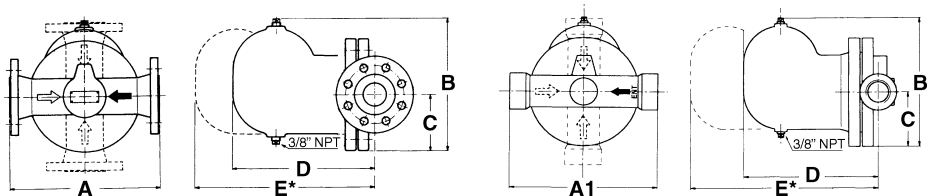

\* Withdrawal distance

#### Connections:

- Black arrow: standard supply configuration (right to left)
- White arrows: optional installation configurations, on request

## 2.4 Materials

N°	Part	Material	
1	Body	SG iron	GJS400 18 LT UNI 1563
2	Cover	SG iron	GJS400 18 LT UNI 1563
3	Cover gasket	Asbestos-free synthetic fibre	
4	Air vent assembly	Stainless steel	
5	Bracket gasket	Asbestos-free synthetic fibre	
6	Bracket assembly	Stainless steel	AISI 304
7	Bracket screws	Stainless steel	AISI 304
8	Lower valve seat	Stainless steel	Series 400C
9	Valve plug	Stainless steel	Series 400C
10	Float arm	Stainless steel	AISI 304
11	Ball float	Stainless steel	AISI 304
12	Drain plug	Carbon steel	ASTM A105
13	Cover studs	Carbon steel	ASTM A193 B7
	Cover nuts	Carbon steel	ASTM A194 8M

## 2.5 Capacities (kg/h)

The condensate discharge capacities shown below are based on condensate at saturation temperature

Differential pressure (bar g)	Trap type			
	GKE 10 DN 40 - 1½"	GKE 10 DN 50 - 2"	GKE 21 DN 40 - 1½"	GKE 21 DN 50 - 2"
0.1	1500	3600	1000	1900
0.3	2500	6000	1700	3300
0.5	3200	7700	2150	4100
0.7	3700	8900	2450	4800
1	4300	10600	2900	5700
1.5	5200	12500	3500	6800
2	6000	14100	4000	7800
4	8400	20000	5500	10500
7	11000	26000	7300	13500
10	13000	30500	8500	16300
12	-	-	9400	18000
14	-	-	10000	19000
18	-	-	12000	21500
21	-	-	12300	22500

The choice of trap should be based on the following data:

- Hourly amount of condensate to be discharged,
- Effective differential pressure,
- Safety factor: 1.25 to 1.5 for continuous use; 2 to 3 for intermittent use.

---

## 3. Installation

---

**Note:** Before actioning any installation observe the 'Safety information' in Section 1.

Referring to the Installation and Maintenance Instructions, name-plate and Technical Information Sheet, check that the product is suitable for the intended installation.

- 3.1** Check materials, pressure and temperature and their maximum values. If the maximum operating limit of the product is lower than that of the system in which it is being fitted, ensure that a safety device is included in the system to prevent overpressurisation.
- 3.2** Determine the correct installation situation and the direction of fluid flow.
- 3.3** Remove protection covers from all connections before installation.
- 3.4** Install the trap below and as close as possible to the drainage outlet; make the connections so that the trap is positioned with the arrow on the body pointed vertically downwards.
- 3.5** Insert a strainer with an adequate capacity immediately ahead of the trap to prevent damage to the device's internal components; in systems with steam recovery, it is recommended to mount a flow indicator downstream of the trap to check that it is working.
- 3.6** Avoid long stretches of connecting pipe, especially if arranged horizontally or rising.
- 3.7** With minimum operating pressures, leave a hydrostatic head of at least one metre between the drainage outlet and the trap.
- 3.8** If the device to be drained is fitted with automatic temperature control, apply a vacuum breaker in addition to the hydrostatic head (see Fig. 1).
- 3.9** If the condensate has to be raised to a height above the trap, install a check valve downstream of the trap.
- 3.10** Avoid raising the condensate in the case of low operating pressure (<1 bar) or automatic temperature control, but use a steam recovery pump.

### 3.11 Changing the connection configuration

The device is supplied with the connections arranged in a horizontal line and in the direction of flow shown in Fig. 2a). To change the arrangement of the connections, use the following procedure, with reference to Fig. 2 and Fig. 3.

- Open the trap by unscrewing the 8 nuts (**13**) using a size 24 wrench and remove the cover (**2**).
- Disassemble the frame, together with the various mechanisms and ball float, by unscrewing the 4 screws (**7**) with a size 13 wrench.
- Change the body position by moving the connections as desired, to one of the possible solutions given at Fig. 2 (a, b, c, d).
- Fix the frame to the body in such a way that the float is free to move vertically from top to bottom and viceversa.
- Close the trap again, making sure that the arrow on the cover is pointing vertically downwards.
- When mounting the frame and closing the cover, make sure that the gaskets are in good condition and correctly positioned.

**Note:** If the trap is to discharge to atmosphere ensure it is to a safe place, the discharging fluid may be at a temperature of 100°C (212°F).

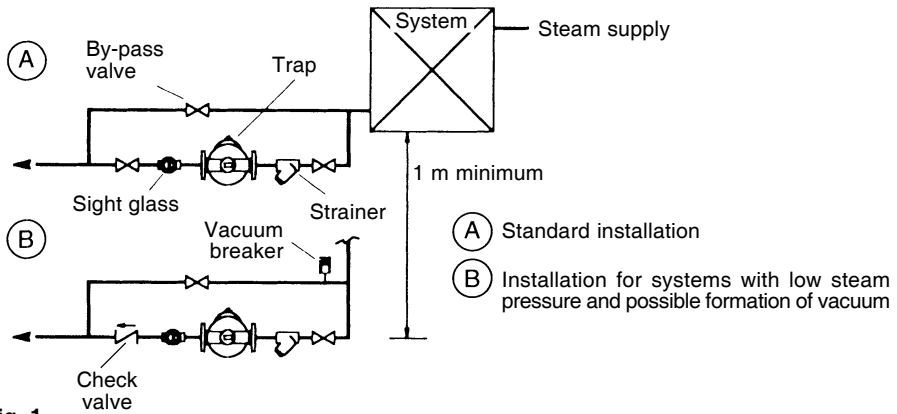

Fig. 1

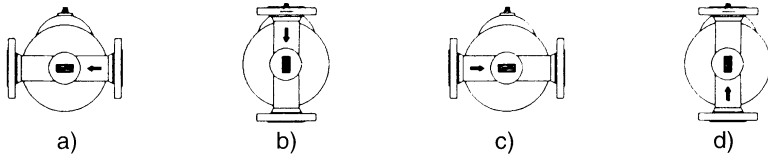

Fig. 2

## 4. Commissioning

After installation or maintenance ensure that the system is fully functioning. Carry out tests on any alarms or protective devices. Always open isolation valves slowly until normal operating condition are achieved. Check for leaks and correct operation.

## 5. Operation

Ball float steam traps quickly remove air, have continuous, modulating condensate discharge, and can adapt immediately even to large or sudden variations of flow and pressure.

# 6. Maintenance

**Note:** Before actioning any maintenance programme observe the "Safety information" in Section 1.

## Safety note:

These traps are installed in medium pressure steam lines. Personnel doing the adjustment and maintenance work should wear heavy gloves, long sleeve shirt and other equipment designed to protect the wearer (goggles, face shield, etc...) in the event of a leak.

## 6.1 General information

To ensure the device's long-term, safe operation, an adequate maintenance programme should be prepared, involving regular inspection and cleaning, for which some important instructions are given below. All work must be carried out or be supervised by a suitable competent person.



Before undertaking any maintenance on the trap it must be isolated from both the supply line and return line and any pressure allowed to safely normalise to atmosphere. The trap should then be allowed to cool. When reassembling, ensure that all joint faces are clean.

## 6.2 Routine Maintenance

Check that the ball float is not deformed and does not contain water; in the case of replacement, do not force the float arm, but remove it by undoing the split pin and dowel and properly blocking it before unscrewing the nut blocking the float.

- Check that the mechanism's movement is not hindered and that the valves move freely to a completely closed position. To replace the main valve assembly, unscrew the four nuts from the bolts. When mounting the new main valve assembly, check its condition and the position of the cover gasket, and tighten the nuts uniformly.
- Inspect and clean the air vent assembly, checking that the passages are free and that the valve plug and discs move without friction. Do not change the valve plug travel.
- Tighten to the recommended tightening torques (see table below).
- After reassembling open isolation valves slowly until normal operating condition are achieved.
- Check for leaks and correct operation.

## Recommended tightening torques

Item	Size		or mm		N m
Cover nuts	1½" - 40	24 A/F		M 16 x 70	90
	2" - 50	24 A/F		M 16 x 70	90
Bracket screws	1½" - 40			M 8 x 15	18.2
	2" - 50			M 8 x 15	18.2

## 7. Spare parts

The spare parts are shown in the drawing below and are available in groupings as indicated in the table. Other parts are not available as spares.

### Available spares

Main valve assembly	3, 5, 6, 7, 8, 9, 10
Ball float and cover gasket assembly	3, 11
Air vent assembly (2 off)	4
Gasket set (3+3 off)	3, 5

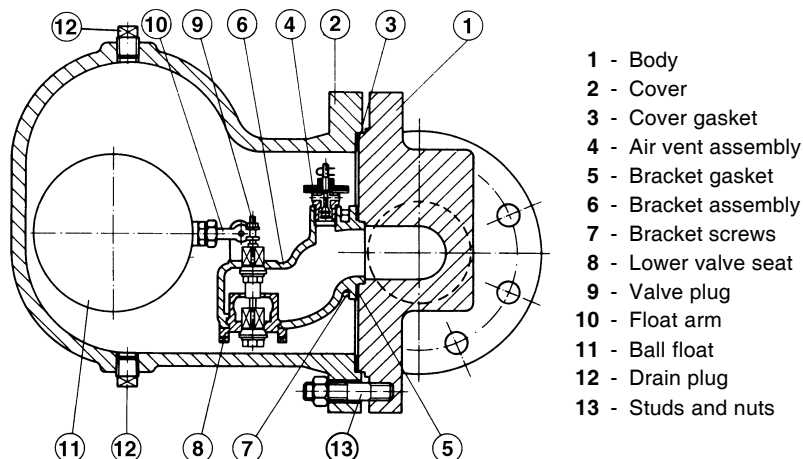

Fig. 3

### How to order spares

Always order spare parts by using the description given in the table and state the size and type of trap, including pressure range and type of the connections.

**Example:** N° 1 main valve assembly for a ball float steam trap Spirax Sarco GKE 21, DN 1½".



---

## **REPAIRS**

Please contact our nearest Branch Office or Agent, or directly Spirax-Sarco S.r.l.

Via per Cinisello, 18 - 20834 Nova Milanese (MB) – ITALY - Tel.: +39 0362 49 17.1 - Fax: +39 0362 49 17 307

## **LOSS OF GUARANTEE**

**Total or partial disregard of above instructions involves loss of any right to guarantee.**

**Spirax-Sarco S.r.l.** - Via per Cinisello, 18 - 20834 Nova Milanese (MB) - Tel.: 0362 49 17.1 - Fax: 0362 49 17 307

---