

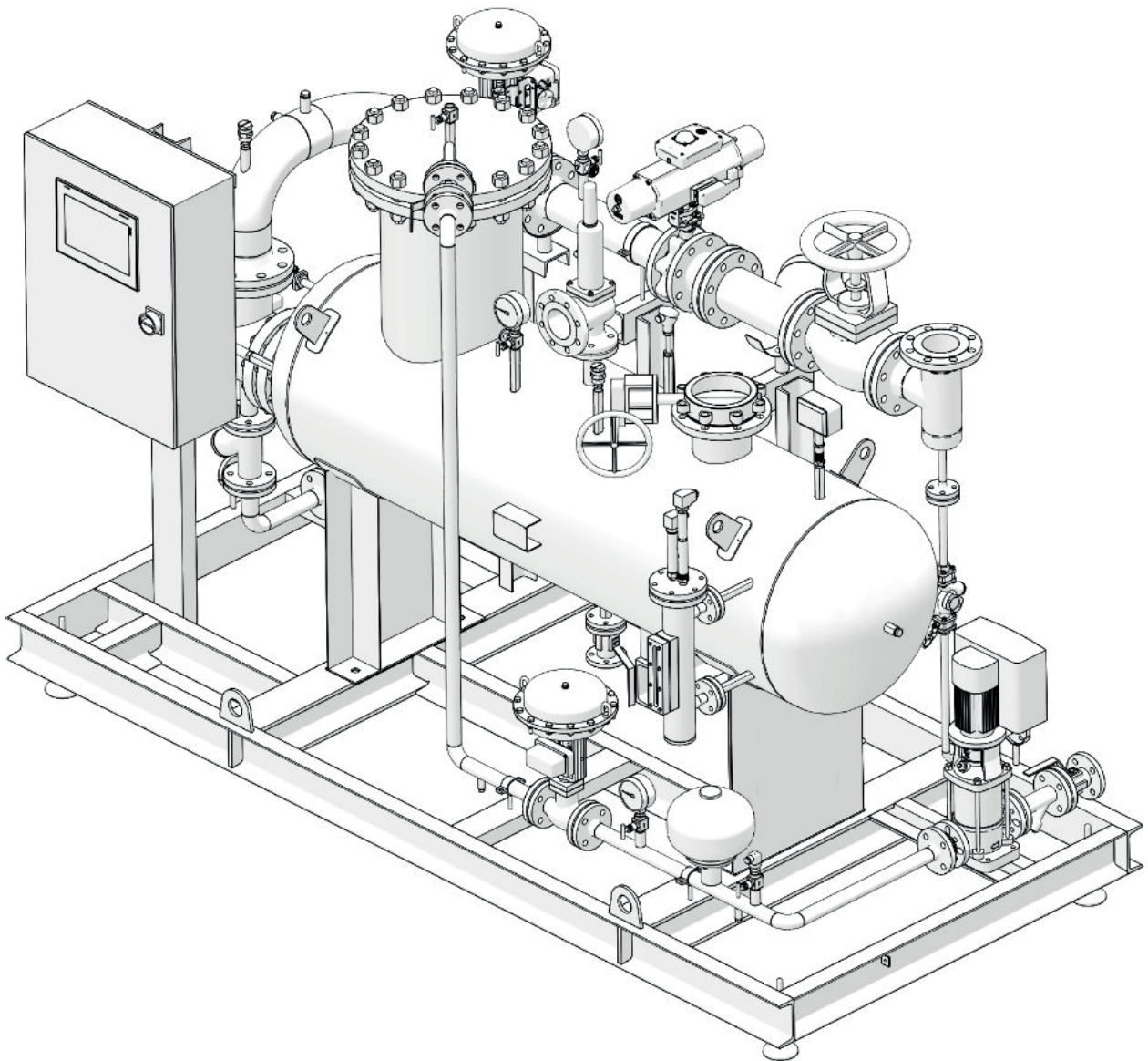

CSG-HS

Clean Steam Generation System

Installation and Maintenance Instructions



Contents

1. Safety information	4	6. Diagnostics	
2. General product information		6.1 Control bands	
2.1 Description	8	6.2 Control capacity	29
2.2 Identification of the product		6.3 Water level failure	
2.3 Product nomenclature and selection guide	10	6.4 High water limit	
2.4 Design conditions	12	6.5 Panel temperature limit	
2.5 Operating limits		6.6 High pressure limit	
2.6 Dimensions and weights	13	6.7 Low water level limit	
3. Installation		6.8 Water pump fault	30
3.1 Installation site		6.9 Water supply failure	
3.2 Handling	14	6.10 Pneumatic supply failure	
3.3 Positioning and fastening		6.11 Supply steam failure	
3.4 Process pipework and vents		6.12 TDS limit	
3.5 Connection of the power supply	18	6.13 TDS hysteresis fault	31
3.6 Connection of air supply		6.14 Trap alarms	
3.7 Electrical specifications	19	6.15 Valve feedback	
3.8 Digital inputs/outputs		6.16 Isolation valve feedback	
4. Commissioning		6.17 Analogue input diagnostic	32
4.1 Pre-commissioning inspection	20	6.18 Optional E-stop triggers	
4.2 On-site commissioning procedure		6.19 Umbrella alarms	
5. System controls	23	6.20 Steam control valve failure	33
5.1 Runtime controls		6.21 Water level control valve failure	
5.2 Manual controls	26		
5.3 PID Tuning			
5.4 Optional functions	27		
5.5 Emergency stop	28		

7. Troubleshooting 34

8. Maintenance

8.1	General information	56
8.2	Inspection/replacement of the tube bundle of the generator	
8.3	Inspection/replacement of the deaerator	57
8.4	Inspection/Replacement of the pressure safety switch	
8.5	Replacement of the Pressure Safety Valve (Generator)	58
8.6	Spare parts	
8.7	Recommend inspection	59
8.8	Spirax Sarco Service maintenance	

9. Component map 60

9.1	System P&ID	
9.2	Component Configuration	62
9.3	Component naming convention	

10. HMI map 64

10.1	Commissioning screens	66
10.2	Home screen	70
10.3	Main menu	72
10.4	Alarms	76
10.5	Display settings	78
10.6	Process settings	79
10.7	Performance data	82
10.8	Data trends	83

11. Appendix 91

Copyright © Spirax-Sarco Limited 2020

All rights reserved

Spirax-Sarco Limited grants the legal user of this product (or device) the right to use the Work(s) solely within the scope of the legitimate operation of the product (or device). No other right is granted under this licence. In particular and without prejudice to the generality of the foregoing, the Work(s) may not be used, sold, licensed, transferred, copied or reproduced in whole or in part or in any manner or form other than as expressly granted here without the prior written consent of Spirax-Sarco Limited.

1. Safety information

In addition to putting your personnel at risk of death or serious harm, failure to comply with the instructions, recommendations and guidance set out in this document may jeopardise your warranty rights. Further, use of the product(s) otherwise than in accordance with this document will be undertaken entirely at your own risk. To the fullest extent legally permitted, Spirax Sarco excludes all responsibility and liability for any and all loss or damage caused in the event that the practices and procedures detailed in this document have not been followed.

Safe operation of these products can be guaranteed only if they are properly installed, commissioned and maintained by a qualified person (see Section 1.11) in compliance with the related operating instructions. General installation and safety instructions for pipeline and plant construction and also the proper use of tools and safety equipment must also be complied with.

General safety notes

This manual is intended to cover the installation, start-up and maintenance procedures of the CSG-HS indirect clean steam generator and must be read in conjunction with the installation and maintenance manuals (IM) of the single components of the unit and related additional safety notes.

Precautions when lifting the unit

The CSG-HS indirect clean steam generator must be lifted from the base depending on the size, adopting a suitable forklift or transpallet for 020 and 055 sizes and using the lifting eye bolts installed on the base frame for 125 and 180 sizes.



**Caution
or
Warning**

Do not lift the CSG-HS indirect clean steam generator by any other part except from the base.

Note: always leave sufficient space around the system for future maintenance operations.

Warnings

1. The unit is designed and constructed to withstand the intensity of work in ordinary use.
2. Use of the product for any other purpose, or failure to install the product in compliance with these Installation and Maintenance Instructions, may damage the product and also cause serious injuries to operating personnel.
3. Before carrying out any installation and maintenance procedure, always check that all primary steam, condensate and water return lines on the secondary have been isolated.
4. Make sure that residual pressure in the system and in pipework has been vented to atmospheric level.
5. To avoid the risk of burns, allow parts to cool before carrying out any type of operation.
6. Always wear suitable protective clothing before carrying out any installation or maintenance activity.

1.1 Intended use

Referring to the installation and maintenance instructions and the nameplate of the unit and the Technical Specifications, check that the product is suitable for intended use/application.

The CSG-HS indirect clean steam generator complies with the requirements of the Pressure Equipment Directive (PED) and is  marked.

- i) The product has been specifically designed for use on steam and water belonging to Group 2 of the above-mentioned Pressure Equipment Directive.
- ii) Check suitability of material, pressure and temperature and related maximum and minimum values. If the maximum operating limits of the product are lower than those of the system in which it to be inserted, or if malfunction of the product could generate dangerous overpressure or overtemperature, always insert a safety device in the system to prevent exceeding of such limits.
- iii) Determine the correct installation position and direction of flow of fluids.
- iv) The product is not designed to withstand external stresses induced by the system in which it is fitted. The installer is responsible for taking into account such stresses and for adopting adequate precautions to reduce these to a minimum.
- v) Prior to installation, remove protective covers from all connections and also protective film and packaging elements.

1.2 Pressure Equipment Directive (PED) classification

The clean steam generators CSG-HS series are classified as assembly according the European Pressure Equipment Directive (PED):

Product	Fluid Group	Category
CSG-HS-020	2	III
CSG-HS-055	2	III
CSG-HS-125	2	IV
CSG-HS-180	2	IV

For the category of bespoke units, refer to the “EC Declaration of Conformity” supplied with the product.

Other component parts of the assembly comply with the relevant European Directives, where necessary. Please refer to specific component literature for further details.

1.3 Access

Ensure safe access and, if necessary, a safe working platform (suitably guarded) before attempting any work on the product. Arrange suitable lifting gear if required.

1.4 Lighting

Ensure adequate lighting, particularly where detailed or intricate work is required.

1.5 Hazardous liquids or gases in the pipeline

Take into account what is currently in the pipeline or what may have been in the pipeline at some previous time. Consider: flammable materials, substances hazardous to health, extreme temperatures.

1.6 Hazardous environment around the product

Consider: areas with a risk of explosion, lack of oxygen (e.g. tanks, pits), dangerous gases, extreme temperatures, hot surfaces, fire hazards (e.g. during welding), excessive noise, moving machinery.

The place of installation of the assembly must be equipped with the fire-prevention devices required by current regulations.

1.7 The system

Consider the effect of the work to be carried out on the entire system. Consider whether the action proposed (e.g. closing of isolating valves, electrical isolation) may put any other part of the system or personnel at risk.

Hazards may include isolation of vents or protective devices or the rendering ineffective of controls or alarms. Ensure isolating valves are opened and closed gradually to avoid shocks to the system.



1.8 Pressure systems

Ensure that any pressure is isolated and safely vented to atmospheric pressure. Consider double isolation (double block and bleed) and locking or labelling of closed valves. Do not assume that the system has depressurised even when the pressure gauge indicates zero.

1.9 Temperature

Allow time for temperature to normalise after isolation to avoid the risk of burns and consider whether protective clothing (including safety glasses) is required.

1.10 Tools and consumables

Before starting work, make sure you have suitable tools and/or consumables on hand. Use only genuine Spirax Sarco replacement parts.

1.11 Protective clothing

Consider whether you and/or others require protective clothing to protect against hazards, such as chemicals, high/low temperatures, radiation, noise, falling objects and danger to eyes and face.

1.12 Permits to work

All work must be carried out or supervised by a suitably competent person. Installation and operating personnel should be trained in correct use of the product according to the Installation and Maintenance Instructions. Any formal work permit system adopted must be complied with. Where no such system is applied, a person responsible should be informed of progress of the work and, where necessary, an assistant with primary responsibility for safety should be appointed. Post "warning signs" if necessary.

1.13 Handling

Manual handling of large and /or heavy products may involve a risk of injury. Lifting, pushing, pulling, carrying or supporting a load by bodily force may cause injury, particularly to the back. You are advised to assess the risks, taking into account the task, the individual, the load and the working environment and use appropriate handling methods according to the circumstances of the work to be carried out.

Note: if it is necessary to use slings for lifting, it is good practice to fit these around the plate of the base unit to avoid damage to the unit.

1.14 Storage

Note: If the Clean Steam Generator cannot be installed and put into operation immediately upon receipt at the jobsite, certain precautions are necessary to prevent deterioration during storage.

Responsibility for integrity of the heat exchangers must be assumed by the user. Spirax Sarco will not be responsible for damage, corrosion or other deterioration of heat exchanger equipment during transit and storage. Good storage practices are important, considering the high costs of repair or replacement, and the possible delays for items which require long lead times for manufacture. The followings suggested practices are provided solely as a convenience to the user, who shall make his own decision on whether to use all or any of them.

- On receipt of the CSG-HS Steam Generation System, inspect for shipping damage to all protective covers. If damage is evident, inspect for possible contamination and replace protective covers as required. If damage is extensive, notify the carrier immediately and Spirax Sarco.
- If the CSG-HS is not to be placed in immediate service, take precautions to prevent rusting or contamination.
- Store under cover in a heated area, if possible. The ideal storage environment for CSG-HS and accessories is indoors, above grade, in a dry, low humidity atmosphere which is sealed to prevent entry of blowing dust, rain or snow. Maintain temperatures between 20°C and 50°C and humidity at 40% relative humidity or lower.

Note: Ambient temperature of the place where the unit will be installed must be above 0°C.

1.15 Freezing

Precautions must be taken to protect products that are not self-draining against frost damage in environments where they may be exposed to temperatures below freezing point.

1.16 Disposal

As the product may contain PTFE and Viton, particular precautions must be adopted to avoid potential risks for health caused by decomposition or combustion of such materials. Unless otherwise indicated in the installation and maintenance instructions with regard to the materials of the seals, this product can be recycled and it is considered that no environmental risk exists deriving from disposal thereof provided that suitable precautions are adopted. However, its components can be checked to verify the possibility of safe disposal.

PTFE:

- This material can be disposed of only using approved systems and never in incinerators.
- PTFE waste to be disposed of must be stocked in separate containers, must never be mixed with other waste and must be sent directly to a landfill.

Viton:

- VITON waste can be sent directly to landfills when permitted and accepted by local and national regulations.
- VITON components may also be incinerated but a scrubber must be used to remove the hydrogen fluoride developed by the product, carrying out this procedure in accordance with local and national regulations.
The components are insoluble in aquatic media.

Electrical:

Unless otherwise stated, the electrical components within this product are recyclable and no ecological hazard is anticipated with its disposal providing due care is taken. The product should be recycled in line with local legislation.

1.17 Return of products

Customers and stockists are reminded that, under EC Health, Safety and Environment Law, when returning products to Spirax Sarco, they must provide information regarding any hazards and precautions to be taken due to contamination residues or mechanical damage which may represent a risk to health, safety or the environmental. This information must be provided in writing, including Health and Safety datasheets relating to any substances identified as hazardous or potentially hazardous.

2. General product information

2.1 Description

The CSG-HS indirect clean steam generator consists of a complete, safe and functional system package, ready for installation and able to produce up to 200/550/1250/1800 kg/h of clean steam (at normal operating conditions) using industrial steam as a primary energy source.

The CSG-HS series of indirect clean steam generators are designed to produce clean steam for sterilisation in hospitals in compliance with EU EN285.

The heat exchange is indirect, for which there is no contamination between the primary steam and the 'clean' steam produced.

Models and applications

Size	CSG-HS-020 for a nominal production of 200 kg/h*	(441 lbs/hr)
	CSG-HS-055 for a nominal production of 550 kg/h*	(1212 lbs/hr)
	CSG-HS-125 for a nominal production of 1250 kg/h*	(2756 lbs/hr)
	CSG-HS-180 for a nominal production of 1800 kg/h*	(3968 lbs/hr)

Applications Sterilisation of containers, generic use of clean steam.

* Nominal steam production at reference operating conditions: primary plant steam at 9 bar g (130 psi g), production at 4 bar g (58 psi g), feedwater at 20 °C (68 °F)

2.2 Identification of the product

The product is identified by the nameplate fastened to the frame.

The CSG-HS unit, (Figure 1), comprises the following main parts:

- 1 Steam generator and instrumentation/accessories, protection and safety devices
- 2 Degassing tower/deaerator basket
- 3 Primary steam control
- 4 Condensate removal
- 5 Feedwater inlet
- 6 Electrical control panel

For a detailed list of equipment and specifications, refer to the P&Id and documentation provided.

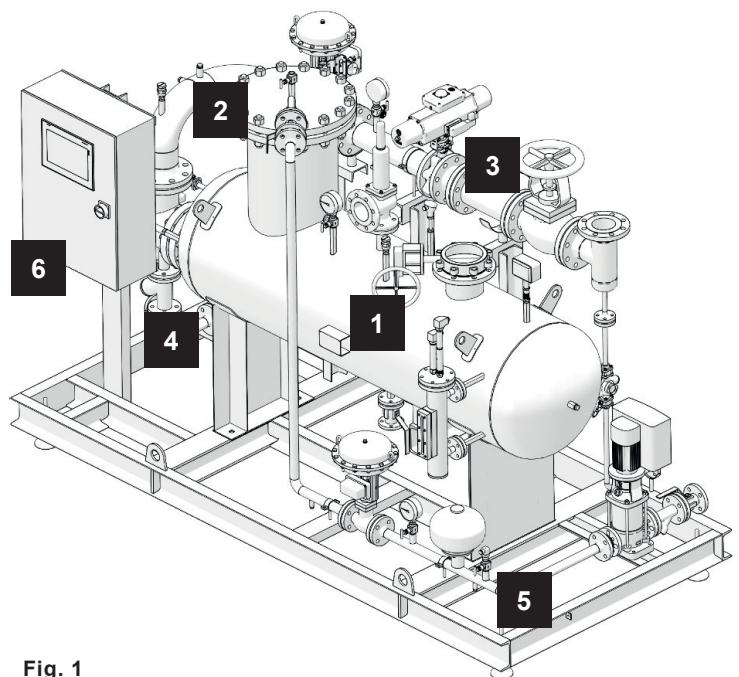

Fig. 1

Notes:

1. For further information concerning individual components refer to the specific technical documentation of each product.
2. Further technical information regarding the CSG-HS indirect clean steam generator can be found in TI-P663-01.

Example of nameplate:

1. "CE" marking and Id. of notified body

Unit PED category

2. Unit model

3. Product Nomenclature= series

- size
- configuration
- options

4. Unit serial No.:

- YY: year
- XXXXXX: identification number (6 or 9 digits)
- ZZ: unit progressive number
- Year of construction

5. Electric and air supply specifications (where required)

6. Fluid group (PED), design conditions and circuit hydro test pressure

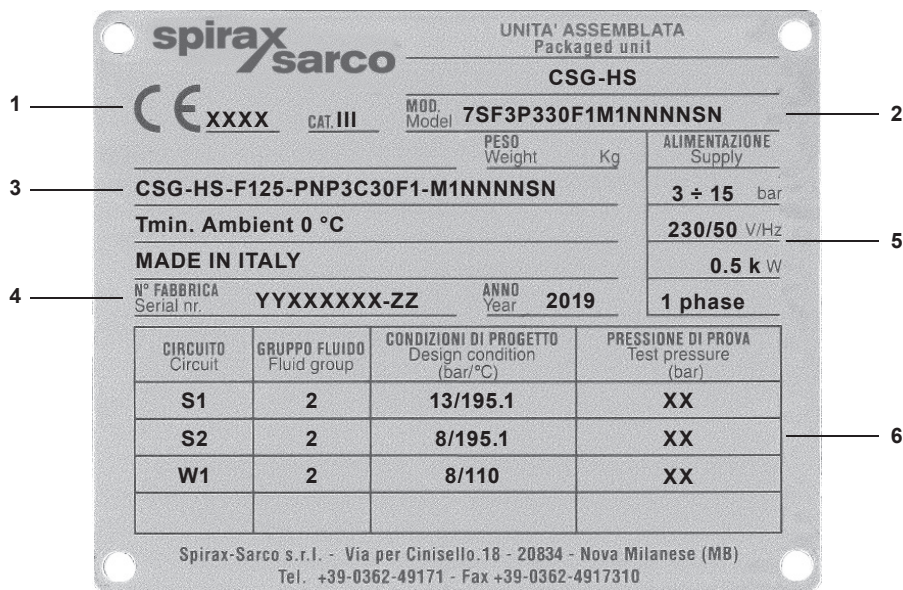

Fig. 2

Note: the pressure values in the nameplate are expressed in 'bar g'.

2.3 Product nomenclature and selection guide

The product nomenclature is based on the characteristics of the main elements and options, identified as follows:

Basic configuration		
Design code	E	EN
	A	ASME
Shell type	F	Flanged openable, shell and tube with integrated deaerator
Unit size:	020	Up to 200 kg/h (at the reference operating conditions ^)
	055	Up to 550 kg/h "
	125	Up to 1250 kg/h "
	180	Up to 1800 kg/h "
Valve actuation type:	PN	Pneumatic (fail-safe)
	EL	Electric (fail-safe)
Control:	P1	EMEA/PLC = ABB AC500 series + 7" display
	P2	EMEA/PLC = Allen-Bradley CompactLogix 1700 series + 7" display
	P3	EMEA/PLC = Siemens S7.1200 series + 7" display
Communication interface:	C0	None
	C1	BACnet IP
	C2	Profinet
	C3	Modbus TCP/IP
	C4	BACnet MSTP
	C5	Profibus
	C6	Modbus RTU
	C7	BACnet (BTL cert.) IP
C8	BACnet (BTL cert.) MSTP	
Unit frame/Electrical cabinet:	0	Base and cabinet made of carbon steel, painted
	1	Open frame and cabinet made of carbon steel, painted
	2	Frame w. side panels and cabinet made of carb. steel, painted
	3	Base and cabinet made of stainless steel (304)
	4	Open frame and cabinet made of stainless steel (304)
Control Panel location	S	Side
	F	Front
Insulation:	1	Steam generator body only
	2	Steam generator and hot piping
	3	Insulation to EEnv specification
	0	Not insulated
Handling wheels and feet:	N	None (only plates with anchor holes are provided)
	F	Adjustable feet
	W	Pivoting wheels, lockable, with feet

Plant steam inlet shut-off valve:	M	Manual stop valve	
	AP	Automatic isolation valve	pneumatic:
	AE		electrical:
Plant steam line trapping:	N	None	
	T	Plant steam line trapping station	
TDS control system:	1	Timed TDS blowdown	
	2	TDS control with external probe (discontinuous metering)	
	3	TDS control system w. internal probe (continuous metering)	
Sampling cooler	N	None	
	S	Sample-cooler and sampling valve	
Feedwater pressurisation system:	N	None (water P > clean steam P + 0,5 bar g)	
	P	Pump with VFD	
Independent downstream plant protection	N	None	
	L	Self-monitoring low level probe LP30 (available only with LP20)	
	T	Temperature limiter	
Feedwater pre-heating:	N	None	
	PR	Feed water pre-heating by heat recovery from primary condensate	
	PRE	Feed water pre-heating by heat recovery + energy monitoring	
Intelligent diagnostics	N	None	
	I1	System diagnostics	
	I2	Performance and condition monitoring	
	I3	Integrity test	
	I4	System diagnostics + Integrity test	
	I5	System diagnostics + Performance and condition monitoring	
	I6	Performance and conditions monitoring + Integrity test	
I7	System diagnostics + Performance and condition monitoring + Integrity test		
Clean steam outlet shut-off valve:	N	None	
	M	Manual stop valve	
	AP	Automatic isolation valve	pneumatic:
	AE		electrical:
Test and certifications:	S	EU PED test and CE marking of the assembly	
Level indicator:	V	Viscorol (Magnetic Level Indicator)	
	L	LP20 (Capacitance Level Probe)	

2.3.1 Product nomenclature example

CSG - HS E F 020 - PN P3 C1 - 1 F 2 F - AE T - 3 S P L N I7 - AE S L

2.4 Design conditions

Primary side	Design pressure	13 bar g	(188 psi g)	The complete condition of the design of the supplied units are reported on the P&ID.
	Design temperature	195.1 °C	(383 °F)	
Secondary side	Design pressure	8 bar g	(116 psi g)	
	Design temperature	195.1 °C	(383 °F)	
	Safety valve set pressure	7 bar g	(101.5 psi g)	
Feedwater	Design pressure	8 bar g	(116 psi g)	
	Design temperature	110 °C	(230 °F)	

2.5 Operating limits

	Without pump	With pump
Production	Clean saturated steam, up to 6 bar g/165.0 °C (Clean saturated steam, up to 97 psi g/206 °F)	
Primary side	Plant steam, up to 12 bar g/191.7 °C (Plant steam, up to 174 psi g/345 °F)	
Feedwater	P min. ≥ P clean steam + 0.5 bar g (P min. ≥ P clean steam + 7.2 psi g)	Net positive suction head required (see below)
	P max 8 bar g/T max 110 °C (P max 116 psi g/T max 230 °F)	P max 8 bar g/T max 80 °C (P max 116 psi g/T max 176 °F)

Minimum pressure of the feedwater at the inlet flange of the units equipped with pump, to avoid cavitation (NPSHR) = P' min. + dP
dP: pressure drop along the water feed pipework, at maximum flow-rate.
P' min. depending on the water temperature:

T	°C	≤ 85	90	95	100	105	110	(*) Under water head
	(°F)	(185)	(194)	(203)	(212)	(221)	(230)	
P' min.	bar g	0*	0.05	0.20	0.35	0.50	0.70	
	(psi g)	(0)	(0.72)	(2.90)	(5.07)	(7.25)	(10.15)	

Minimum ambient temperature: 0 °C (32 °F).

Maximum ambient temperature: 40 °C (104 °F)

Unit designed for indoor installation, protect from freezing.

To ensure the correct operation of the clean steam generator, the inlet feed water should have the following characteristics. An excess on these values can compromise the lifetime, maintenance and efficiency of the steam generator.

pH	5.5 ÷ 7.5 (at 20 °C) (5.5 ÷ 7.5 (at 68 °F))	Hardness	≤ 0.02 mmol/l
Chloride	≤ 5 mg/l	Conductivity	≤ 20 µS/cm

Attention

In the case the unit CSG-HS is used as a source of steam for sterilization purposes in accordance with EN 285:2015 (E) the characteristics of inlet feedwater should be in accordance with the same normative EN 285:2015 (E).

Note: Compliance can be tested in accordance with acknowledged analytical methods.

2.6 Dimensions and weights

approximate in mm (inches) and kg (lbs) of a standard unit

	Dimensions mm (inches)				Weights kg (lbs)		
	L Length	W Width	H Height	E Clearance for tube bundle extraction	Empty	In operation	Maximum
020	2000 (79)	850 (33)	1850 (73)	1250 (49)	600 (1322)	700 (1543)	850 (1873)
055	2350 (93)	850 (33)	1850 (73)	1300 (51)	900 (1984)	1100 (2425)	1300 (2866)
125	2450 (96)	1450 (57)	2060 (81)	1600 (63)	1200 (2645)	1550 (3417)	1800 (3968)
180	2950 (116)	1450 (57)	2065 (82)	2000 (78)	1600 (3527)	2100 (4629)	2500 (5511)

Indicated dimensions are the maximum dimensions for a specific configuration of the package.

For detailed dimensions of the unit, size and position of the connections, clearance for the tube bundle extraction, weights and other constructive information, refer to the specific general arrangement drawing of the product.

Fig. 3 CSG-HS-055 shown

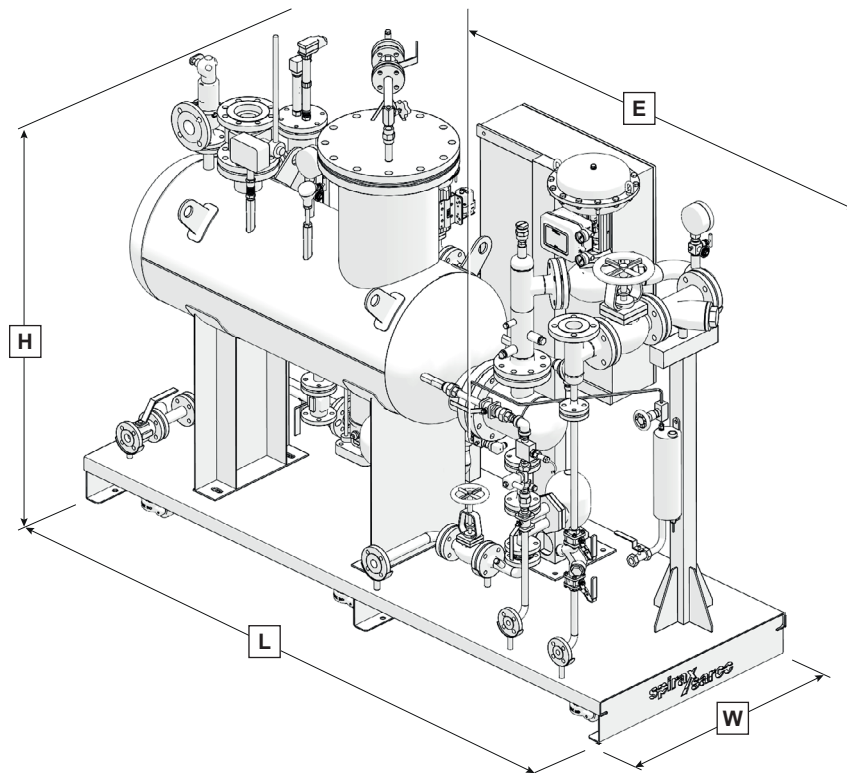

3. Installation

3.1 Installation site

The CSG-HS unit is designed for installation indoors with a minimum ambient temperature of 0 °C (32 °F). Installation outdoors is permitted provided that the unit is suitably protected against adverse weather conditions and freezing.

The unit is not suitable for installation in potentially hazardous zones classified as ATEX. Specific solutions can be provided on request.

3.2 Handling

020/055 sizes: The CSG-HS unit must be lifted from the base using suitable forklift or transpallet. Do not use any eyebolts of equipment on board the unit. If fitted with wheels for handling (option), the unit must be moved in safe conditions and then secured in position using the integrated mounting feet.

125/180 sizes: The CSG-HS unit must be lifted from the lifting eyebolts mounted on the base of the unit.

	<p>Do not lift the unit by other parts or in any manner other than as indicated above.</p> <p>During lifting, take into account the high centre of gravity of the unit and adopt all the necessary precautions to avoid accidental tipping over of the unit.</p>
--	--

3.3 Positioning and fastening

The unit must be positioned on a completely flat, horizontal surface able to support its entire weight at full load. For access to the unit, provide at least one metre of clearance around, and 0.5 m (1.64 ft) above. A space for tube bundle removal has to be considered.

3.4 Process pipework and vents

Each unit is provided complete with drawings indicating the position and specifications of connections to be made according to configuration and options ordered.

The main connections of the unit are as follows:

UNI-EN 1092-1 PN16/25/40 connection flanges

For other pipework, according to options installed, refer to the dimensional (or G.A.) drawing of the unit provided.

020 and 055 size

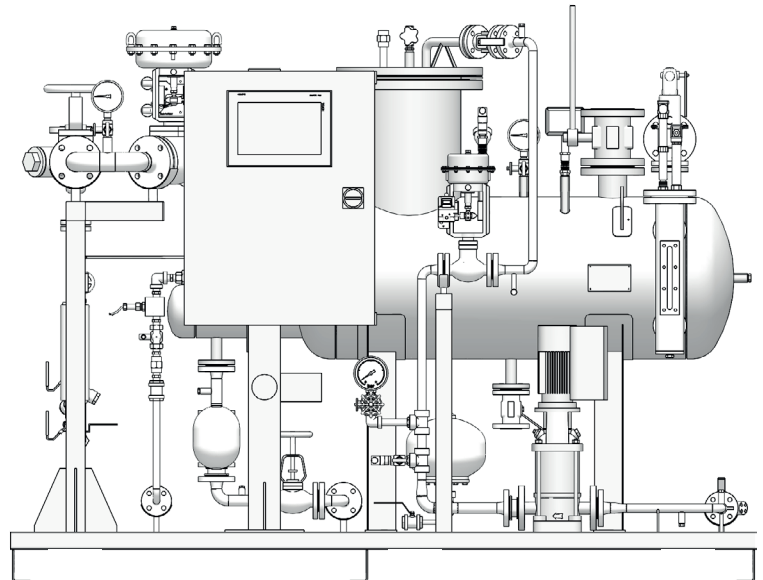

125 and 180 size

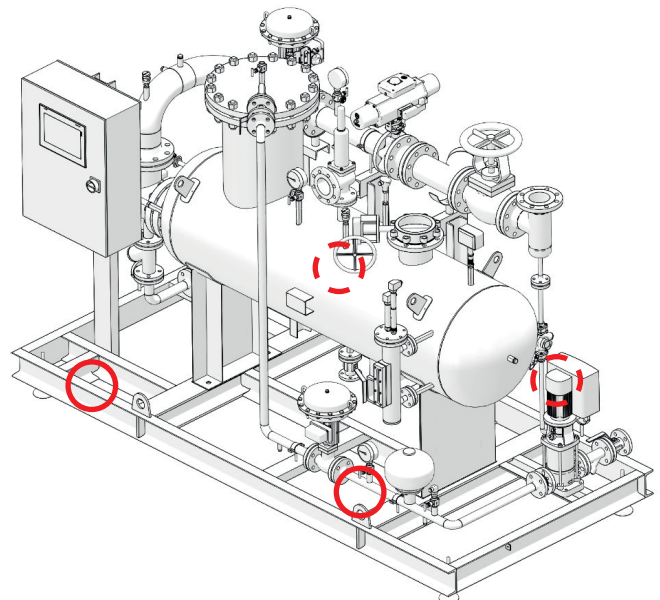

Ring-nut for extraction/withdrawal of mounting foot

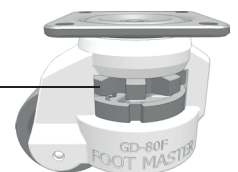
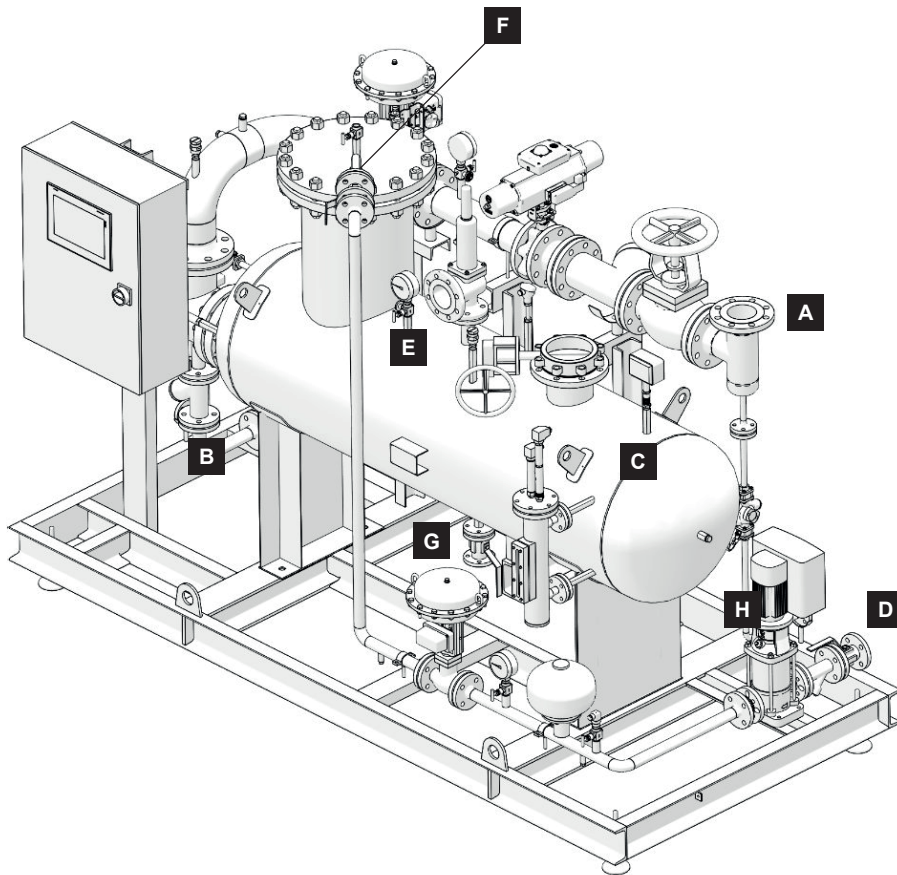

Fig. 4

Connections

		020	055	125	180
A	Plant steam inlet connection	DN32 PN25	DN50 PN25	DN80 PN25	DN100 PN25
B	Condensate outlet connection	DN25 PN40	DN25 PN40	DN40 PN40	DN40 PN40
C	Clean steam outlet connection	DN50 PN40	DN80 PN40	DN125 PN16	DN150 PN16
D	Feedwater inlet connection	DN15 PN40	DN20 PN40	DN25 PN40	DN32 PN40
E	Safety valve discharge	1" G-f	DN50 PN16	DN80 PN16	DN80 PN16
F	Not condensable vent connection	¼" G-f	¼" G-f	¼" G-f	¼" G-f
G	Drain connection	DN25 PN40	DN25 PN40	DN25 PN40	DN25 PN40
H	Plant steam condensate drain connection	DN15 PN40	DN15 PN40	DN15 PN40	DN15 PN40
I	TDS Blowdown connection	DN15 PN40	DN15 PN40	DN15 PN40	DN15 PN40
J	Sampling system (cooling water in/out - sample out)	½" BSP - 6 mm	½" BSP - 6 mm	½" BSP - 6 mm	½" BSP - 6 mm
Options					

Fig. 5



The steam supplied to the CSG-HS unit must be as dry and clean as possible in accordance with the guidelines of sound steam engineering practices. It is also necessary to verify that all pipes are suitably supported without any excessive loads or stress.

	<p>Before making any connection, check that all pipework is clean and free of foreign material or scale that may adversely affect functioning and/or the performance of the unit.</p> <p>The steam supplied must always be maintained within design operating pressure and temperature limits. The unit shall not work above the design pressures and temperatures indicated on the name plate on the package.</p> <p>The drawings provided in this manual are for guidance purposes only. For connections of the unit, always consult the attached drawings.</p>
---	--

3.4.1 Feedwater inlet

The first step of the installation procedure consists in connecting the unit to the cold feedwater line. The manual isolating valve on the feedwater control line of the unit must remain closed until installation has been completed. The precise position of the feedwater inlet connections, the pipe diameter and size of the attachment flange can be deduced from the drawings provided with the unit.

3.4.2 Clean steam outlet

The next step in the installation procedure is to connect the clean steam outlet of the generator to the clean steam distribution network of the plant. The precise position of the clean steam outlet, the pipe diameter and size of the attachment flange can be deduced from the drawings provided with the unit. A manual isolating valve (if option is not selected) should be installed downstream of the unit on the clean steam line to permit isolation of the generator. This valve must remain closed until installation has been completed.

Note: In the case of units installed in parallel with another generator(s) (common clean steam distribution line), a check valve must be installed on the steam outlet of each generator.

3.4.3 Primary energy source (industrial steam)

Connect the inlet of the primary fluid of the unit to the technological steam distribution network of the plant. The manual (if fitted) isolating valve installed on the primary fluid control line must be closed and remain closed during installation. The precise position of the primary fluid connection, the pipe diameter and size of the attachment flange can be deduced from the drawings provided with the unit.

	<p>Potential risk of also fatal injury.</p>
---	--

3.4.4 Condensate removal

Transfer of heat from the primary steam to the produced (clean steam) generates condensate. The condensate removal from the unit must therefore be connected to the condensate return line of the plant. The manual isolating valve installed on the condensate removal line of the unit must be closed and remain closed during installation. The precise position of the condensate removal connection, the pipe diameter and size of the attachment flange can be deduced from the drawings provided with the unit.

3.4.5 Piping the pressure relief valve to vent and drain

As required by current regulations, CSG-HS unit generators are equipped with a pressure relief valve to protect against the risk of overpressure. Venting of the pressure relief valve (steam) shall be directed towards a safe area to avoid injuries or damage. In most applications, the pressure safety valves should be vented to atmosphere (generally through the roof). The piping used in the vent system shall be of adequate size to handle the capacity of the pressure safety valve. The vent piping system shall be suitable drained to prevent formation of condensate inside this. **The vent pipe of the pressure relief valve shall not be intercepted in any way or even partially obstructed.** For further information and prescriptions regarding connection of the vent piping of the pressure safety valve, refer to the related use and maintenance manual. Venting of the pressure relief valve shall comply with current legislation. The purchaser/installer is responsible for such conformity.

3.4.6 Drainage of the generator

The CSG-HS steam generators are equipped with a drain/bottom blowdown line with manual valve installed on the lower part of the vessel. The blowdown from this valve is at the same pressure and temperature of the generated steam and can cause severe injury or death if not properly piped. In accordance with local regulations or standards, it is recommended that the blowdown lines be connected to a blowdown vessel or condensate cooler before being discharged to drain.

The precise position of the drainage of the generator connection and also pipe diameter and size of the attachment flange can be taken from the drawings supplied with the unit.

The drains of the generator cannot be placed back in the circuit return condensate or feedwater.

3.4.7 Non-condensable gases vent

The CSG-HS steam generators are equipped with a manual control valve to regulate NCG removal. Please refer to the below table for setting the valve based on working pressure of the CSG-HS.

Flowrate 5 kg/h (size 020 and 055):

Steam pressure: 2 bar	→ ¾ or a turn
Steam pressure: 3 bar	→ ¾ or a turn
Steam pressure: 4 bar	→ ½ turn
Steam pressure: 5 bar	→ ½ turn
Steam pressure: 6 bar	→ ½ turn

Flowrate 10 kg/h (size 125 and 180):

Steam pressure: 2 bar	→ Fully open
Steam pressure: 3 bar	→ 1 and ¾ turns
Steam pressure: 4 bar	→ 1 turn
Steam pressure: 5 bar	→ 1 turn
Steam pressure: 6 bar	→ ¾ of a turn

Venting of the NCG valve shall be directed towards a safe area to avoid injuries or damage. In most applications, the NCG valves should be vented to atmosphere (generally through the roof). Venting of the NCG valve shall comply with current legislation. The purchaser/installer is responsible for such conformity.

3.4.8 Other blowdown, venting, drainage facilities (where required)

The CSG-HS can be equipped with optional systems for blowdown, drainage and venting, such as for example a TDS control system, primary steam drainage line. In accordance with current legislation, blowdown from the TDS control system should be connected to a blowdown vessel or condensate cooler before being discharged to drain. TDS blowdown shall not be connected to the condensate return line. Primary steam blowdown can be connected to the condensate return line of the plant. Any purge/drain should not be recovered reintegrating the line/water storage tank of feedwater.

3.5 Connection of the power supply

For voltage connections, consult the wiring diagram provided for the unit.

	<p>Possible injury or death Before connecting the power supply, check that the main power switch and system start selector are off (0 position).</p>
---	---

Where indicated in the wiring diagram, single phase or 3 phase power supplies are to be connected directly to the main isolation switch. Earth points are provided and must always be connected. Power supplies and earth connections must pass through the appropriate number of cable glands to maintain the IP rating for the electrical panel.

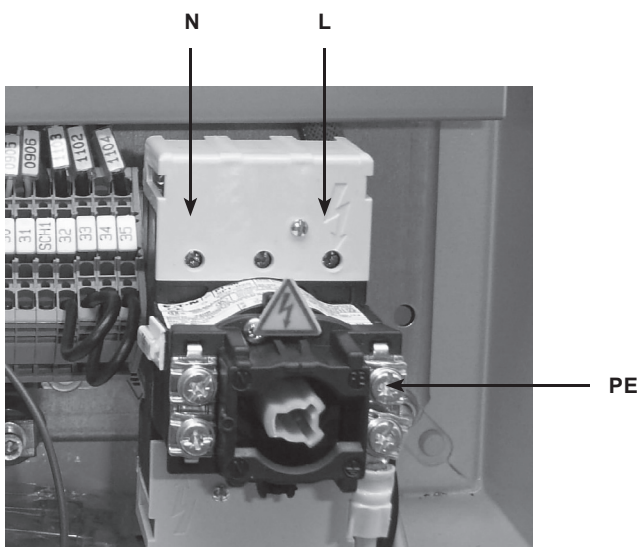

Fig. 6
Version with single-phase power supply

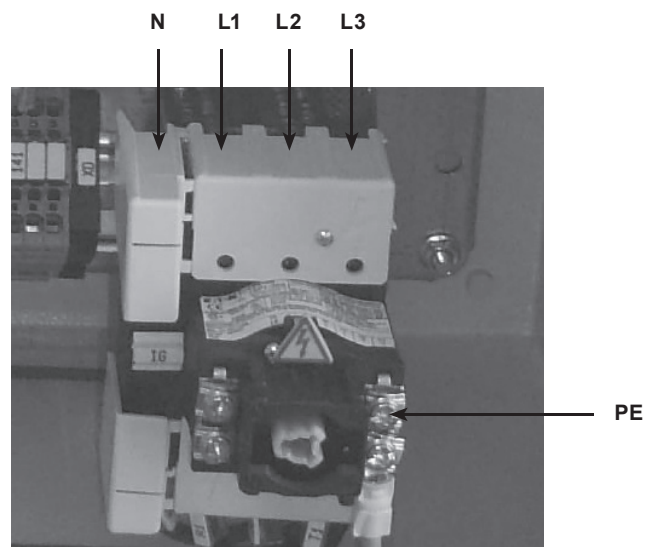



Fig. 7
Version with three-phase + N power supply

	<p>All electrical connections must be made by qualified electricians.</p> <p>The user is responsible for the suitability of electrical connections outside the unit and for their conformity with current legislation.</p> <p>Before drilling holes in the cabinet of the control panel to connect the power cables and any interface with an external system, open the door very carefully and check that there are no obstacles inside the cabinet. Ensure that there is no contact between electrical cables inside the panel with drilling residues or with metal.</p> <p>Signal cables must not be laid together with power cables outside the unit to avoid disturbances and interference during operation. Failure to comply may cause also irreparable damage to the equipment.</p> <p>The user must install a device between the power supply and control panel able to cut off the power if necessary. It is important to check compatibility of the mains supply with that required by the control panel, verifying correspondence with voltage and frequency data indicated on the nameplate.</p> <p>Unused wires in conduit must be grounded at both ends to avoid a possible shock hazard caused by induced voltages.</p> <p>The user is responsible for power connections outside the unit and their compliance with current legislation.</p>
---	---

3.6 Connection of air supply (where necessary)

If pneumatic actuators or integrity test options are selected, the compressed air must be as dry and clean as possible in accordance with the guidelines of sound engineering practice.

Connect the compressed air supply (minimum 5 bar g - maximum 7 bar g (72.5 psi g - 101.5 psi g)) to the pressure regulators fitted on the valves (CV1 and CV2).

So, before starting, adjust the downstream pressure reducers at least 1 bar g above the spring range of pneumatic actuators (if any):

Actuator spring ranges	Primary steam control valve CV1 with electro-pneumatic positioner SP400 (SP500 as option)	Feedwater control valve CV2 with I/P converter (positioner SP500 as option)
020	2 – 4 bar g (29 - 58 psi g)	0.4 – 1.2 bar g (5.8 - 17.4 psi g)
055	1 – 2 bar g (14.5 - 29 psi g)	0.4 – 1.2 bar g (5.8 - 17.4 psi g)
125	2 – 4 bar g (29 - 58 psi g)	1 – 2 bar g (14.5 - 29 psi g)
180	2.5 – 3.5 bar g (36.2 - 50.7 psi g)	1 – 2 bar g (14.5 - 29 psi g)

3.7 Electrical specifications

For detailed electrical information, consult the wiring diagram supplied with the unit.

Type	Rated power	Suggested supply protection
Single Phase 110/230 Vac (no pump)	0.5 kW	8A, C Curve MCB
3 Phase, 200-230 Vac with pump	5 kW	20A C Curve MCB
3 Phase, 380-460 Vac with pump	5 kW	16A, C Curve MCB

3.8 Digital inputs/outputs (on all versions)

For wiring, consult wiring diagram provided with the unit.

The control system for the CSG-HS can provide signals to the customer to enable monitoring of the processes. This is facilitated by the use of industrial communications. The communications protocols are included in the nomenclature and are listed below.

4. Commissioning

For correct commissioning, we recommend the service and support of a Spirax Sarco engineer. Please contact your local Spirax Sarco representative for more details.

4.1 Pre-commissioning inspection (initial start-up)

- Most of the new installations during the construction of pipelines and the installation of the system, may inadvertently collect dirt particles inside the pipes. It is essential to carefully remove any residual impurities and dirt in them before starting the commissioning.
- Check that all the manual isolating valves (on primary stream, on condensate blowdown, on clean steam intake and on feedwater) are closed.
- Clean the filters upstream of the regulation valves.
- Check that the bottom drain valve VM11 (or VE11) of the unit is closed.
- Make sure that the unit power supply is disconnected.
- Check that primary steam and feedwater design conditions do not exceed the rated values of the unit.
- Check that the design conditions of the downstream system, clean steam side, are not lower than the rated data of the unit or in any case not lower than the calibration pressure of the safety valve installed on the unit, secondary side.
- Check that the feedwater line is properly pressurised and has been vented.
- Check that the supply steam (primary) line is properly pressurised and has been drained/ vented.
- Check that the clean steam line has been drained/vented.
- Check that the air supply line, if any, complies with system requirements.
- Check that the power supply complies with the system requirements.
- Make a double check to verify that all connections to steam, condensate and water lines have been made correctly.
- Check that the bolts of the flanged attachments are correctly torqued.
- Check that all the electrical connections outside and inside the unit, are verifying compliance with the wiring diagram (see wiring diagram supplied with the unit).
- Check the air supply of the filters/reducers of the valves (actuated pneumatically where established) and that it complies with the system requirements.

4.1.1 CLEANING before start-up

The clean steam generator is supplied after a pickling and passivation cycle.

4.2 On-site commissioning procedure

The CSG-HS control system has an integrated commissioning sequence designed to guide the user through configuring, starting and tuning the systems PID settings from factory.

It is assumed at this point that all required pipe connections and services have been connected. To begin the commissioning sequence, all connected services must be available and all critical alarms must be cleared.

1. Using the Bolt torque table, ensure that all fittings and flanges are tightened to their correct settings. Ideally these should be identified with a marking compound to allow checks before proceeding.
2. Close all manually operated steam isolation valves and provide steam to that part in the line. If automated isolation valves have been fitted, open all manually operated steam isolation valves.
3. Open all manually operated condensate valves from the customer's connection.
4. Open any manually operated valves downstream of the TDS valve VE12.
5. If Integrity test option is fitted, open any manually operated valves connected the Drain Valve VE11.
6. Ensure that the NCG valve VM22 is open by the correct number of turns for the intended set pressure.
7. Open any manually operated valves upstream water inlet to the CSG-HS.
8. Ensure that all trip switches inside the control panel are set to on.

9. Switch the control panel Isolator to the On position.
10. Check that all pneumatic positioners (if fitted) are set to Auto.
11. Power on the control panel and wait for the Spirax Sarco welcome page.
12. Tap the welcome page to view the Home Screen.
13. At the home screen, select the Main Menu button.



14. Select the System Menu button.



15. Select the Service screen button.



16. Select "First Start Up" button and confirm.
17. Input the correct clean steam pressure set point



and water level

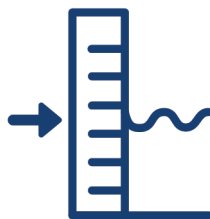

and press the start button.

18. Follow the on screen instructions.
19. If, as part of an integrity test, a leak is detected, repair the leak and repeat the test. It may be necessary to turn off the control panel to fix the leak. Repeat steps 17-21 to restart the commissioning sequence and re-check for any leaks.
20. At the PID Tuning screen, the control system can now simulate high loads and low loads to allow the PID settings to be changed to ensure correct running of the unit.



Low demand simulation button

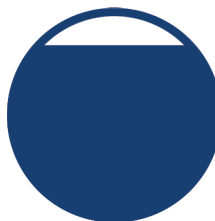

High demand simulation button

21. At least one high demand simulation and one low demand simulation is required to complete the commissioning sequence. Select the green tick button to complete.



The commissioning sequence is now complete and the unit will continue to run at the selected pressure and level set points.

The default settings loaded during the commissioning sequence should be sufficient for the majority of simple applications. However, process settings and alarm settings should always be adjusted to suit individual applications and installations.

Once the commissioning sequence has been completed, the settings should be saved from the Factory settings screen. These settings can be updated or loaded from the Factory settings screen on the HMI.



4.3 Start-up procedure

Once the commissioning procedure is complete, the CSG-HS can now be started from the Home screen.

- If automated plant steam isolation valves have been selected, open any manually controlled valves upstream.
- Follow any on screen instructions.



4.4 Shut-down procedure

Once the unit has begun its start-up sequence, the start button is replaced with the Stop button.

- Follow any on screen instructions.



4.5 Ambient conditions

When the unit is out of service in a low ambient temperature space, with a risk of freezing, it is necessary to completely empty the unit.

	<p>Ice inside the generator and inside primary steam line/condensate and feedwater can severely damage the equipment</p>
---	---

5. System controls

The CSG-HS control system has a range of controls and functions to ensure the safe and stable running of the unit. Not all functions are available depending upon the configuration of the CSG-HS, these are denoted by the* symbol.

5.1 Runtime controls

Runtime controls affect the response of the CSG-HS and are only active whilst the unit is 'running'. During standby, these controls are not enabled.

5.1.1 Automated start-up

The Automated start-up sequence controls the safe start-up of the CSG-HS from cold and empty condition all the way through to fully pressurised and correct water level.

Detailed instructions can be provided by a Spirax Sarco engineer, however a simplified sequence can be found below.

- Raise water level to low level.
- Open automated clean steam outlet isolation valve (if fitted).
- Open automated plant steam isolation valve (if fitted).
- Control valve opens a small amount to warm up unit.
- 105 °C (221 °F) clean steam temperature is measured.
- 0.5 bar g (7.25 psi g) clean steam pressure is measured.
- Ramp up pressure to set point.
- Raise water level to set point.
- Check for pressure and water at correct set point.
- End sequence and start Run sequence.



5.1.2 Automated recovery

If the CSG-HS is still hot or pressurised from previous use, the control system can restart the unit without having to gently warm up the heating coils.

Detailed instructions can be provided by a Spirax Sarco engineer, however a simplified sequence can be found below.

- Maintain current water level or raise to low level.
- Open automated clean steam outlet isolation valve (if fitted).
- Open automated plant steam isolation valve (if fitted).
- Ramp up pressure to set point.
- Raise water level to set point.
- Check for pressure and water at correct set point.
- End sequence and start Run sequence.

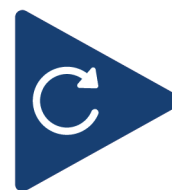

5.1.3 Automated sequenced shut-down

The automated shut-down sequence ensures that the unit is in an optimal condition such that, when it begins the start-up sequence, the time taken is to reach running conditions is as little as possible.

This includes reducing the water level to the 'low level' so that less time is required to reach saturation temperature.

Detailed instructions can be provided by a Spirax Sarco engineer, however a simplified sequence can be found below.

- Reduce water level to low level or wait for timer limit.
- Ramp down steam set point to 0.
- Close automated plant steam inlet (if fitted).
- Wait for water temperature to drop below 110 °C (212 °F).
- Stop water control.
- Close outlet isolation valve (if fitted).
- End sequence and start standby.



5.1.4 Clean steam pressure control

Control of the clean steam pressure is maintained by use of a PID control loop program in the PLC using pressure sensor PA21 as the process variable. See section 7 for component map. The steam PID set point (set during commissioning sequence) can be adjusted from the Process Settings screen. The steam PID control value is sent directly to the steam control valve VB31.

The Steam PID set point value can be overridden by the PLC during several processes. These include Ramp up/down (see section 5.1.7), Forward controls (see section 5.1.8) and PID tuning (see section 5.3).

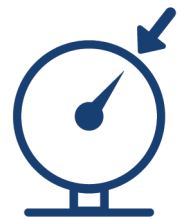

5.1.5 Water level control

Control of the water level within the clean steam side of the CSG-HS is maintained by use of a PID control loop program in the PLC using level sensor LA11 as the process variable. The water level PID set point (set during commissioning sequence) can be adjusted from the Process settings screen. The water level PID control value is sent directly to the water control valve VB01.

The water level PID set point can be overridden by the PLC during several processes.

These include Forward controls (see section 5.1.8), Automated start-up (see section 5.1.1), Automated recovery (see section 5.1.2) and Automated shutdown (see section 5.1.3).

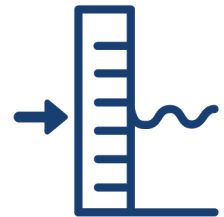

5.1.6 TDS control

Some TDS controls are only available with the correct options fitted when ordering the CSG-HS. The following options may be available on screen if fitted. All automated TDS controls are only enabled when in Run mode. All settings are accessible from the TDS Settings screen in the Process settings area.

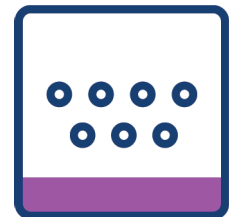

5.1.6.1 Interval control

Available across all TDS control options, Interval control relies on a 2 timers to open and close the TDS valve VE12.

If either of the conductivity sensor options are fitted, a limit value for the TDS is still be set on screen and used for process diagnostics.



5.1.6.2 Continuous hysteresis control*

With the inclusion of a conductivity sensor CA11 fitted in the shell of the CSG-HS, the conductivity of the water can be continuously monitored. This allows the TDS valve VE12 to open when the TDS limit set-point is reached and close once the conductivity has been reduced by the TDS Hysteresis set-point.

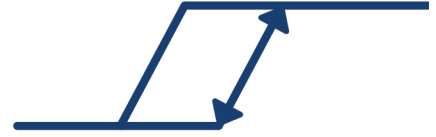

5.1.6.3 Pulsed hysteresis control*

With the inclusion of a conductivity sensor CA11 fitted in the TDS blowdown line of the CSG-HS, the conductivity of the water can only be monitored when the TDS valve VE12 is open. The interval and duration of these checks must be set to allow a reliable TDS value to be read.

If, whilst the TDS valve is open, the conductivity reading is above the TDS set-point, the valve will remain open until the conductivity reading reduces by the Hysteresis set-point.

5.1.7 Ramp up/down

At the initiation of the Clean Steam pressure control, the set-point sent to the PID program is always ramped up from 0 to the desired set-point over a period of time. This ramp up is used in the automated start-up and recovery sequences.

Similarly, if the clean steam pressure set-point is altered whilst the CSG-HS is running, the ramp sequence will alter the set-point over the ramp period.

The ramp up and ramp down time period can be altered on the Process Settings screen.

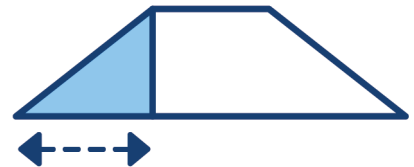

5.1.8 Forward controls

Forward controls are used to anticipate extra-ordinary running conditions in order to ensure safe and reliable running of the CSG-HS. There are two conditions that are monitored and two respective controls processes designed to handle them. The Forward Controls settings page can be found in the Process Settings area.

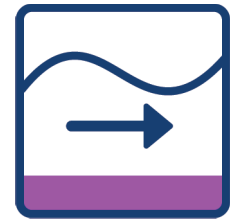

5.1.8.1 Rapid high demand

If a significant and prolonged period of high demand results in a drop of Clean Steam pressure PA21, then the water level set-point is temporarily raised. This is designed to anticipate the rapid level loss due to flash boiling of the water in the CSG-HS due to the drop in pressure.

The values used for the Clean Steam pressure drop, duration of the drop, the raise in water level set-point and the duration of the set-point raise can all be set from the Forward Controls settings screen.



5.1.8.2 Rapid low demand

If a rapid spike in Clean Steam pressure PA21 is detected, then the set-point used for the Clean Steam pressure is temporarily lowered. This is designed to reduce the amount of energy in the CSG-HS and reduce the risk of over-pressurisation.

The values used for the Clean Steam pressure raise rate, reduction of the Clean Steam pressure set-point and duration of the set-point raise can all be set from the Forward Controls settings screen.



5.1.9 Water pump*

If the integrated booster pump is fitted, CSG-HS can independently control water pressure fed directly to the Clean Steam side. The control signal sent to the pump is a target pressure to which the pump drives to. The target pressure is calculated as the pressure currently detected Clean Steam Pressure PA21 + Pump offset. The pump can also be set to maintain a continuous pressure rather than an offset. This option is only available at commissioning by a Spirax Sarco Engineer. The Pump offset or fixed setpoint can be set from the Water PID settings page in the Process Settings area.

As the pump has its own control system, no bypass loop is required to prevent over-pressurisation.

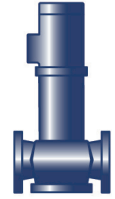

5.1.10 Ball Valve anti-binding*

The ball valve anti-binding sequence ensures that ball valves which are subjected to prolonged periods in the open position do not stick. To do this, any ball valves fitted to the CSG-HS that are in the open position at midnight each day are given a closed signal for 1 second. After this 1 second closed signal, valves will return to their open position.

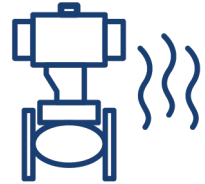

5.1.11 High water level

If, whilst in Run mode, the water level in the CSG-HS triggers the Control Band high alarm (see section 6.1), the TDS valve VE12 is opened. When the water level returns to the operating set-point, the TDS valve closes.

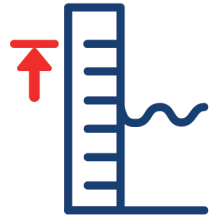

5.2 Manual controls

All manual controls are accessible from the Override screen in the System area. All fitted automated valves fitted to the CSG-HS are able to be controlled manually whilst the system is in Standby mode. Whilst the system is in any other mode, manual controls are not available.

On/off valves can be opened or closed using their respective toggle button on the screen. Control valves can be moved to a specified position once the valve has been enabled. Disabling the valve will return the valve to closed position.

Whilst manual controls are enabled, the CSG-HS will not begin Automated Start-up or Recovery. All manual controls must be reset before continuing.

A warning is displayed if the clean steam temperature inside the CSG-HS has exceeded 100 °C (212 °F). This is to prevent accidental discharge of hot water or steam.



5.3 PID Tuning

PID Tuning is a series of processes that allow the system to simulate loads rises and drops on a running CSG-HS. In order to do this, the PID Tuning sequence reduces the current Clean Steam Pressure set-point by 1 bar g (14.5 psi g).

Once the CSG-HS is running at the PID Tuning set-point, the user can either instantaneously; increase the set-point by 0.5 bar g (7.3 psi g) to simulate high demand, or decrease the set-point by 0.5 bar g (7.3 psi g) to simulate low demand. With either of the simulations, the PID controller will now react accordingly allowing the user to set P, I and D values for both water control and steam control to ensure safe and stable running.

The PID Tuning screen is accessible as part of the commissioning sequence, from standby by selecting the 'PID Tuning Sequence' button, and whilst running by selecting 'Running PID Tuning'.

If PID tuning is initiated from standby or commissioning, the CSG-HS will start normally using the Automated Start-up sequence as described in section 4.2.

If Running PID tuning is selected, the system will reduce the clean steam pressure set-point by 1 bar g (14.5 psi g) and the PID tuning screen will be visible.



5.4 Optional functions

All functions in this section are part of the optional features packs and will not be available without the correct configuration.

5.4.1 Integrity test*

The integrity test option includes all the necessary valves and measurement equipment to fully isolate the inlet steam side of the CSG-HS from the Steam Control valve VB31 to the Condensate Isolation valve VE51 and perform a pneumatic pressure decay test. This test, when selected will be conducted at the beginning of the next Automated Start-up sequence. At the end of a failed Integrity Test, the user will be prompted to either re-test, stop the start-up sequence or ignore the test and continue the Automated Start-up. Successful test will not provide any feedback and continue with the Automated Start-up sequence.

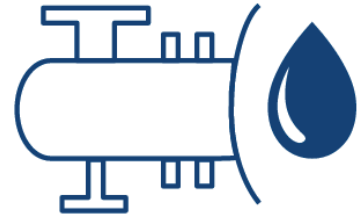

An Integrity test will always be performed at the First Start-up as part of the commissioning sequence. This test cannot be ignored. The Integrity test can only be re-started or stop the Automated Start-up sequence entirely.

5.4.2 Service sequence*

In order to facilitate the safe and easy maintenance of the CSG-HS, a guided service sequence is available to give a servicing engineer the ability to verify valve operation and clean the heating elements.

Whilst the service sequence is in operation, the CSG-HS cannot go into run mode or begin Automated Start-up.

The Service Sequence initialisation is located in the Service screen in the System area. Operators are instructed to manually isolate all external connections to and from the CSG-HS. This includes plant steam, drain, water, condensate and clean steam lines.



In order to ensure that components are safe to operate independently, a series of temperature and pressure sensors are located throughout the CSG-HS. If a temperature above 25 °C (77 °F) or pressure of 0.1 bar g (1.45 psi g) is detected at any point, all controls are automatically set to a safe position and the service sequence is halted.

Prior to and during the 'Cleaning' phase, the screen will indicate a safe (green), not safe (red) indicator next to each sensor monitored around the CSG-HS to allow the engineer to identify if it is safe to remove components on the unit. At this stage, if the control panel is powered down, the service sequence is retained within the memory of the controller and will return to the same point when power is returned to the panel. This ensures that the Automated Start-up sequence cannot be initiated if components are missing from the CSG-HS.

5.4.3 Performance monitoring*

Performance monitoring is a series of sampling, calculation and comparison algorithms that map the performance of the CSG-HS over the full range of operation flow ranges. The flow ranges for each model of the CSG-HS are preloaded into the program and are automatically loaded during the commissioning sequence. With a performance map, the performance of the CSG-HS can be monitored for leaks in or scaling on the heating elements.



The sampling period is limited to a maximum of 10 samples over the flow range or 100 hours of running. After this period the CSG is assumed to no longer be operating under best conditions. Without a minimum of 3 samples, the calculation and comparison algorithms will not operate. Once sufficient data has been collected and the calculation algorithm has been allowed to run, the comparison algorithm can now compare the current run conditions with the ideal model created by the sampling algorithm.

The Performance Ratio Fault Tolerance value is a percentage difference when comparing the mapped value to the current sampled value. Samples exceeding the positive tolerance value are experiencing a drop in performance (typically due to scale build up), while samples dropping below the negative tolerance value are experiencing abnormal increase in energy transfer (typically due to a leak from the plant steam directly into the clean steam). Respective alarms are shown in the alarm screens when tolerances are exceeded. Settings, live readouts and mapped data from the Performance Monitoring algorithms can be found on the Performance Data area of the HMI.

HINT: Key to the accuracy of the Performance Monitoring is the accuracy of the sample data. Specifically ensuring that the measured water flow is as steady as possible. To facilitate this, a series of data filters are available to ensure that flow readings are kept free from anomalous spikes and drops.

5.5 Emergency stop

The emergency stop program constantly monitors a set of diagnostic systems and will prevent the running of the CSG-HS if any of these diagnostics triggers and alarm. The emergency stop can only reset and allow the running of the system when the cause of the alarm is cleared. In addition to the cleared alarms, the Reset pushbutton must also be pressed to clear the Emergency Stop.



When the emergency stop is triggered, the status of the CSG-HS is changed directly to 'Emergency Stop', overriding any previous run status. Additionally, all automated isolation valves are reset, control valves are closed and the water pump (if fitted) is disabled.

The diagnostics systems monitored vary depending upon the current run status. For any run status other than Running (i.e. Automated start-up, restart, sequenced shutdown, integrity test and standby) the systems are listed below. See section 6 for more details on individual diagnostics.

- Emergency stop push button
- Major Instrument failure
- Steam control valve failure
- Water control valve failure
- Water pump failure*
- Process limit switches
- Air pressure failure*
- Water supply failure.*
- Electric valve condition alarm

When the CSG-HS is in Running mode, the following alarms are monitored:

- Emergency stop push button
- Major Instrument failure
- Steam control valve failure
- Water control valve failure
- Water pump failure*
- Process limit switches
- Air pressure failure*
- Water level low limit*
- Electric valve condition alarm
- Supply pressure failure*
- Water level control failure
- Water supply failure*
- Water level high limit
- Optional E-stops

6. Diagnostics

Not all diagnostics are available depending upon the configuration of the CSG-HS, these are denoted by the* symbol.

6.1 Control bands

Clean Steam Pressure Control and Water Level Control are both monitored by separate Control Bands, however both control bands operate the same way.

Control Bands monitor their respective process value and compare to the set-point. Upper and lower bands are defined by percentage value from the set-point. If the process value exceeds either the high or low band tolerances a timer is started. If the timer exceeds the Band Alert time a Control Band Alert is issued to the Alarms screen.

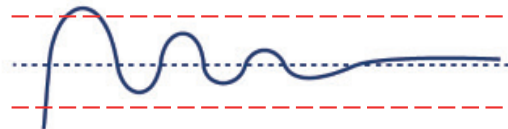

If the process value continues to exceed the band tolerances and the timer continues past the Band Alarm time, then a Control Band Alarm is issued to the Alarms screen. If the process value returns to within the band tolerances, the timer is reset.

Control Bands only monitor in Run mode and not in the PID Tuning sequence. Alarms and Alerts reset when the process value returns to within the upper and lower bands.

Note: Control Band alarms are used by other diagnostic systems. Correct setup at commissioning is critical to robust controls, accurate diagnostics and reduction of nuisance alarms.

6.2 Control capacity

The Control capacity diagnostic monitors both the control value from the PID program and the Control band high alarm for the respective process. This provides engineers with a tool to identify if the capacity of either of the control system is at its limit and thus impacting performance of the CSG-HS.

Clean steam pressure control and Water level control are both monitored by separate Control Capacity diagnostics, however both operate the same way.

If the control valve is fully open for a period of time and the Control band high alarm is active, then the Control Capacity alarm is triggered. If the control valve is fully open for a period of time and the Control Band high alarm is not active, the Control capacity alert is triggered.

Alarms and Alerts reset when the control valve closes from being fully open.



6.3 Water level failure

The Water level failure diagnostic monitors the High Water Level control system (see section 5.1.11). If the High water level cycle is triggered a number of times within a certain time period, the Water Level Failure alarm is triggered.

The number of repeated triggers and timer period are editable on the HMI.

The alarm is only reset when the Reset pushbutton is pressed.

6.4 High water limit

The High water limit diagnostic monitors the Level sensor LA11 to stop the CSG-HS over filling. When the water level sensor reads 90%, the High Water Level alarm is triggered.

The alarm is reset when the water level reduces below 90%.

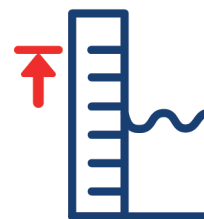

6.5 Panel temperature limit

The panel temperature of the CSG-HS is monitored by a PT100 temperature sensor located inside cable trunking of the electrical panel TAX1. If the temperature exceeds the maximum ambient operating temperature of 55 °C (131 °F), the Panel Temperature Alarm is triggered.

The alarm is reset when the measured temperature reduces below 55 °C (131 °F).

6.6 High pressure limit

Each CSG-HS is fitted with a mechanical pressure switch PD21 set to the maximum operating pressure for the unit. This switch is set by the manufacturer prior to dispatch. This pressure switch triggers the Process limit switch alarm.

The alarm is reset when the clean steam pressure is low enough for the mechanical pressure switch to reset.

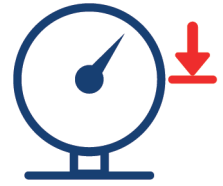

6.7 Low water level limit*

The Low water level limit diagnostic prevents the exposure of the heating elements and the alarm can be triggered by two methods.

If the level sensor LA11 gives a reading of less than 40%.

If the optional low level switch LD11 is triggered.

The alarm is reset by the water level raising enough to clear the water level switch or be above 40% on the level sensor.



6.8 Water pump fault*

The optional integrated water pump MB01 provides a simple diagnostic feedback signal MD01 which is only triggered when there is a fault with the pump or the control of the pump pressure.

The alarm is cleared when the fault is cleared from the water pump.



6.9 Water supply failure*

The Water supply failure diagnostic monitors the water supply pressure PA01 and is only activated when the integrated water pump is not fitted.

When active, the water supply pressure is compared to the control pressure that would be sent to the integrated pump (see section 5.1.9). If the supply pressure is below the control signal, the Water supply failure alarm is triggered.

The alarm is cleared when the supply pressure exceeds the control signal that is generated for the water pump.

6.10 Pneumatic supply failure*

When fitted, the Pneumatic supply pressure switch PDX1 is used to monitor the compressed air supply to the CSG-HS. If the air supply pressure drops below the minimum required pressure, the alarm is triggered.

The alarm is cleared when the pneumatic supply pressure increases above the minimum required pressure.

6.11 Supply steam failure*

The Supply steam failure diagnostic monitors the control signal sent to the Steam control valve VB31 and the Steam inlet pressure PA13 whilst in the 'Running' state. When the control signal requests the control valve to be fully open for longer than 60 seconds and the Steam Inlet pressure is below the current clean steam pressure set-point. The alarm is triggered.

The alarm is cleared once the pressure rises above the clean steam pressure set-point.

6.12 TDS limit*

When fitted with a conductivity sensor CA11, the TDS limit diagnostic monitors the conductivity and will trigger an alarm if the TDS set-point is exceeded for a period of time. The alarm is cleared when the measured conductivity is reduced below the TDS set-point.

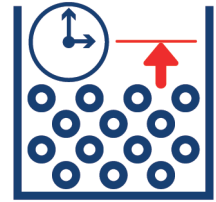

6.13 TDS hysteresis fault*

The TDS hysteresis fault diagnostic closely monitors the TDS control system, specifically the Hysteresis controls. When hysteresis is engaged and the TDS valve is opened, a timer is started. If the timer expires before the measured conductivity reduces by the hysteresis setting, the alarm is triggered. The alarm is reset when the measured conductivity reduces by the hysteresis setting.

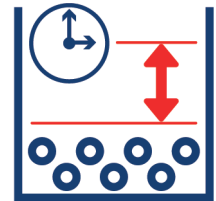

6.14 Trap alarms*

The Trap alarm diagnostics can be split into two conditions based around the two alarms. The alarm for either condition is reset by pressing the Reset pushbutton.



6.14.1 Trap fail open

During normal running conditions, the trap of the CSG-HS will be constantly discharging condensate. As such a failed open trap would not be easily detectable. However, at low flow conditions, it is easier to identify the trap discharging excessive amount of condensate and eventually live steam.

The Trap Failed Open alarm is triggered when the control valve is only open a small amount, and the condensate temperature sensor TA51 and the drain temperature sensor TA52 are similar temperatures. The maximum valve temperature and maximum difference between temperature sensors can be set on the HMI.



6.14.2 Trap failed closed

The Trap failed closed alarm monitors the drain temperature sensor TA52. Based on the below calculation, the minimum operating temperature of the drain condensate after the trap can be determined. If, whilst in Running status, the condensate temperature drops below this temperature, the Trap Failed Closed alarm will activate.

Note: there are many causes of blockages in the condensate line that can cause the measured drain temperature to drop below minimum operating condensate temperature. If after investigation, the trap is operating properly, there may be another cause for the backup of condensate, including external to the CSG-HS.



6.15 Valve feedback*

The Steam control valve VB31 and the Water level control valve VB01 are both monitored by separate Valve Feedback diagnostics, however both operate the same way. The valve feedback diagnostics are disabled during the Service Sequence (see section 5.4.2).

The valve feedback diagnostic monitors the control values sent to the control valve compares this to the valve feedback signal for their respective control valves (Steam control valve feedback VA31, Water level control valve feedback VA01). A positive and negative tolerance from the control signal is calculated. If the valve feedback is not within that tolerance, a timer is started. If the timer expires, the alarm is triggered. The alarm is reset when the control valve feedback reads within the position tolerance.

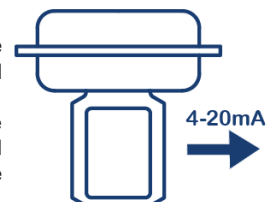

6.16 Isolation valve feedback*

The Steam inlet VE31, Clean steam outlet VE01, Bottom drain valve VE11 are independently monitored by separate Isolation valve feedback diagnostics.

6.16.1 Fail closed

If the valve does not rotate enough to come off the valve closed limit switch within a time limit when commanded, the valve failed closed alarm is triggered.

The alarm is reset when the valve rotates enough to turn off the valve closed limit switch.

6.16.2 Fail open

If the valve does not rotate enough to come off the valve open limit switch within a time limit when commanded, the valve failed open alarm is triggered.

The alarm is reset when the valve rotates enough to turn off the valve open limit switch.

6.16.3 Partial open failure

If, when commanded, the valve takes too long to transition from closed to open, or from open to closed, the Partial open failure alarm is triggered.

The alarm is reset if the valve completes the rotation and triggers the correct limit switch.

6.16.4 Open speed

If, when commanded, the valve opens too quickly, the Open speed alarm is triggered. The alarm is reset when the correct valve opening speed is achieved.

6.17 Analogue input diagnostic

The Analogue input diagnostic is able to detect if an analogue input signal has been electrically disconnected from the system (sensor failure, wires disconnected, etc), or if the signal wires have been directly connected (wires pinched or damaged). The Open circuit alarm and Short circuit alarms are triggered respectively.

The alarms are reset when a correct input signal is detected.

6.18 Optional E-stop triggers

All alarms, not already included in the Emergency stop sequence (see section 5.5), have the option of triggering an emergency stop. When enabled, the alarms must be cleared before the emergency stop sequence can be reset.

6.19 Umbrella alarms

Umbrella alarms are not directly displayed on the Alarms page of the HMI. These alarms are collective names given to alarms used in the Emergency stop sequence (see section 5.5)

6.19.1 Major instrument fault

The Major instrument fault covers the analogue input alarms for all sensors that are essential the safe running of the CSG-HS. If any of these analogue input alarms are triggered, the Emergency Stop sequence will be started and will not be able to be reset until the alarms are cleared.

The following Analogue Input Diagnostic alarms are included in the Major Instrument Fault umbrella alarms:

- Clean steam temperature TA21
- Control panel temperature TAX1
- Water pressure PA01‡
- Clean steam pressure PA21
- Water level LA11

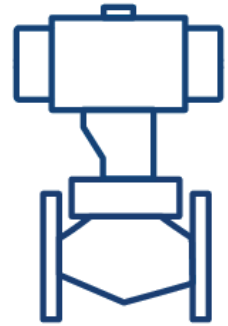

6.20 Steam control valve failure

The Steam control valve failure covers all diagnostics related to the Steam control valve VB31. If any of the alarms associated with these diagnostics are triggered, the Emergency stop sequence will be started and will not be able to be reset until the alarms are cleared.

The following diagnostic alarms are included in the Steam control valve failure umbrella alarm:

- Valve Feedback analogue input diagnostics VA31
- Valve Feedback diagnostic VA31



6.21 Water level control valve failure

The Water level control valve failure covers all diagnostics related to the Water level control valve (VB01). If any of the alarms associated with these diagnostics are triggered, the Emergency stop sequence will be started and will not be able to be reset until the alarms are cleared.

The following diagnostic alarms are included in the Water level control valve failure umbrella alarm:

- Valve feedback analogue input diagnostics VA01
- Valve feedback diagnostic VA01



7. Troubleshooting

Alarm number	Alarm PLC tag	Alarm description	Identifier			Fault
			Physical	Process	System	
1	ALA_PERF_CACL	Heat exchanger scaling alarm	-	Begin to lose flow capacity	More primary steam required	Scale formation on heating element
2	ALA_PERF_LEAK	Supply steam leaking through to clean side alarm	-	-	Over pressure during low flow conditions	Leaking from primary to secondary side
3	ALA_TEST_LEAK	Cold leak test alarm	Leak pipe joints	Ceased production of clean steam	Emergency stop displayed	Leak in pipe joints
			Leak in steam control valve			Leak in steam control valve
			Leaks in Integrity test valves			Leak in isolation valves
4	ALARM_SERV_STOP	Temperature or pressure alarm in service sequence	Hot pipes		Temperature or pressure detected	System isolation not complete
5	CA11_ANLG_ALA_OPEN	Water conductivity Analog input alarm circuit open	Cables removed from sensor	-	Flashing conductivity readings	Wire removed from sensor
						Sensor failure
						BC3250 controller failure
6	CA11_ANLG_ALA_SHRT	Water conductivity Analog input alarm short circuit	Pinched cable from sensor	-	Flashing conductivity readings	Wire pinched or kinked
						Sensor failure
						BC3250 controller failure

	Component					Cause			Action
	TAG number	Item description	Control type	Zone	Instance	Alarm No	ALARM PLC TAG	ALARM DESCRIPTION	
	-	-	-	-	-	Poor water quality/water hardness			Remove and clean heating elements
									Improve water quality
						Manufacturing fault			Replace heating element
						Fatigue			Identify failed part with tag and schematic in IMI. Consult individual product IMI by scanning the QR or following web search. Replace or repair failed part.
	-	-	-	-	-	-			Inspect pipe joints
	VA31	Steam control valve	Anaolgue input	3	1	-			Inspect steam control valve
	-	-	-	-	-	-			Inspect isolation valves
						7	COND_TEMP_HI	Condensate temperature hot	Inspect isolation valves
						11	FEED_PRES_HI	Feedwater pressurised	
						12	FEED_TEMP_HI	Feedwater temperature hot	
						25	PRI_PRES_HI	Primary side pressurised	
						27	PRI_TEMP_HI	Primary side temperature hot	
						32	SEC_PRES_HI	Secondary side pressurised	
						33	SEC_TEMP_HI	Clean steam temperature hot	
						62	WASTE_TEMP_HI	Waste steam temperature hot	
						64	WASTE_TEMP_HI	Water in temperature hot	
						Operator error			Replace cable
	CA11	Conductivity sensor	Analogue input	1	1	Refer to technical documentation			Replace sensor
						Operator error			Replace cable
	CA11	Conductivity sensor	Analogue input	1	1	Refer to technical documentation			Replace sensor
						Refer to technical documentation			Replace controller

Troubleshooting continued on next page

Alarm number	Alarm PLC tag	Alarm description	Identifier			Fault
			Physical	Process	System	
7	COND_TEMP_HI	Condensate temperature hot	Temperature exceeds 40 °C/104 °F	-	High condensate temperature alarm	System isolation not complete
9	FA01_ANLG_ALA_OPEN	Feedwater flow rate Analog input alarm circuit open	Cables removed from sensor	-	Flashing conductivity readings	Wire removed from sensor
						Sensor failure
						BC3250 controller failure
10	FA01_ANLG_ALA_SHRT	Feedwater flow rate temperature Analog input alarm short circuit	Pinched cable from sensor	-	Flashing conductivity readings	Wire pinched or kinked
						Sensor failure
						BC3250 controller failure
11	FEED_PRES_HI	Feedwater pressurised	Pressure exceeds 0.1 bar g/ 1.45 psi g	-	Warning displayed	Service sequence
					Emergency stop	
12	FEED_TEMP_HI	Feedwater temperature hot	Temperature exceeds 40 °C/104 °F	-	Warning displayed	Service sequence
					Emergency stop	
13	LA11_ANLG_ALA_OPEN	Panel temperature analogue input alarm circuit open	Cables removed from sensor	Ceased production of clean steam	Emergency stop displayed on HMI/ Flashing conductivity readings	Wire removed from sensor
						Sensor failure
						BC3250 controller failure
14	LA11_ANLG_ALA_SHRT	Panel temperature analogue input alarm short circuit	Pinched cable from sensor	Ceased production of clean steam	Emergency stop displayed on HMI/ Flashing conductivity readings	Wire pinched or kinked
						Sensor failure
						BC3250 controller failure
16	PA01_ANLG_ALA_OPEN	Panel temperature analogue input alarm circuit open	Cables removed from sensor	Ceased production of clean steam	Emergency stop displayed on HMI/ Flashing conductivity readings	Wire removed from sensor
						Sensor failure
						BC3250 controller failure
17	PA01_ANLG_ALA_SHRT	Panel temperature analogue input alarm short circuit	Pinched cable from sensor	Ceased production of clean steam	Emergency stop displayed on HMI/ Flashing conductivity readings	Wire pinched or kinked
						Sensor failure
						BC3250 controller failure

	Component					Cause			Action
	TAG number	Item description	Control type	Zone	Instance	Alarm No	ALARM PLC TAG	ALARM DESCRIPTION	
	TA41	Temperature sensor	Analogue input	4	1			Operator error	Close isolation valve VM51
	FA01	Flowmeter	Analogue input	0	1			Operator error	Replace cable
							Refer to technical documentation	Replace sensor	
							Refer to technical documentation	Replace controller	
	FA01	Flowmeter	Analogue input	0	1			Operator error	Replace cable
							Refer to technical documentation	Replace sensor	
							Refer to technical documentation	Replace controller	
	-	-	-	-	-			Insufficient isolation during servicing	Work and check isolation valves
	-	-	-	-	-			Insufficient isolation during servicing	Work and check isolation valves
	LA11	Level sensor	Analogue input	1	1			Operator error	Replace cable
							Refer to technical documentation	Replace sensor	
							Refer to technical documentation	Replace controller	
	LA11	Level sensor	Analogue input	1	1			Operator error	Replace cable
							Refer to technical documentation	Replace sensor	
							Refer to technical documentation	Replace controller	
	PA01	Pressure sensor	Analogue input	0	1			Operator error	Replace cable
							Refer to technical documentation	Replace sensor	
							Refer to technical documentation	Replace controller	
	PA01	Pressure sensor	Analogue input	0	1			Operator error	Replace cable
							Refer to technical documentation	Replace sensor	
							Refer to technical documentation	Replace controller	

Troubleshooting continued on next page

Alarm number	Alarm PLC tag	Alarm description	Identifier			Fault
			Physical	Process	System	
18	PA21_ANLG_ALA_OPEN	Panel temperature analogue input alarm circuit open	Cables removed from sensor	Ceased production of clean steam	Emergency stop displayed on HMI/ Flashing conductivity readings	Wire removed from sensor
						Sensor failure
						BC3250 controller failure
19	PA21_ANLG_ALA_SHRT	Panel temperature analogue input alarm short circuit	Pinched cable from sensor	Ceased production of clean steam	Emergency stop displayed on HMI/ Flashing conductivity readings	Wire pinched or kinked
						Sensor failure
						BC3250 controller failure
20	PA31_ANLG_ALA_OPEN	Supply steam in pressure Analog input alarm circuit open	Cables removed from sensor	-	Flashing conductivity readings	Wire removed from sensor
						Sensor failure
						BC3250 controller failure
21	PA31_ANLG_ALA_SHRT	Supply steam in pressure Analog input alarm short circuit	Pinched cable from sensor	-	Flashing conductivity readings	Wire pinched or kinked
						Sensor failure
						BC3250 controller failure
22	PRI_BAND_HI_ALARM	Primary band HIGH alarm	-	Emergency stop sequence - Ceased production of clean steam	Emergency stop displayed on HMI	Reduced primary pressure
23	PRI_BAND_LOW_ALARM	Primary band LOW alarm	Control valve failed closed	Emergency stop sequence - Ceased production of clean steam	Emergency stop displayed on HMI	Customer steam supply
24	PRI_CAP_ALARM	Primary control capacity alarm	Valve over 99% open	Target clean steam pressure not achieved	Alarm displayed on HMI	Steam demand exceeds CSG capacity.
25	PRI_PRES_HI	Primary side pressurised	Pressure exceeds 0.1 bar g/ 1.45 psi g	-	Emergency stop displayed on HMI	Service sequence
26	PRI_PRES_LOW	Primary pressure low alarm	Valve 100% open	Emergency stop sequence - Ceased production of clean steam	Emergency stop displayed on HMI	Primary pressure PA31 lower than setpoint for clean steam pressure
27	PRI_TEMP_HI	Primary side temperature hot	Temperature exceeds 40 °C/104 °F	-	-	-
28	SEC_BAND_HI_ALARM	Secondary band HIGH alarm	-	-	Alarm displayed on HMI	Leaking within valve
						PID Settings

	Component					Cause			Action
	TAG number	Item description	Control type	Zone	Instance	Alarm No	ALARM PLC TAG	ALARM DESCRIPTION	
	PA21	Pressure sensor	Analogue input	2	1	Operator error		Replace cable	
						Refer to technical documentation		Replace sensor	
						Refer to technical documentation		Replace controller	
	PA21	Pressure sensor	Analogue input	2	1	Operator error		Replace cable	
						Refer to technical documentation		Replace sensor	
						Refer to technical documentation		Replace controller	
	PA31	Pressure sensor	Analogue input	3	1	Operator error		Replace cable	
						Refer to technical documentation		Replace sensor	
						Refer to technical documentation		Replace controller	
	PA31	Pressure sensor	Analogue input	3	1	Operator error		Replace cable	
						Refer to technical documentation		Replace sensor	
						Refer to technical documentation		Replace controller	
	-	-	-	-	-	Setpoint not achieved		Re-tune system	
								Leaking control valve	
	-	-	-	-	-	Codensate blockage		Tune PID	
						Insuffiecnt customer steam supply/ Qaulity of inlet steam		Fix Inlet steam supply	
	-	-	-	-	-	Insufficient capacity		Review IMI to check capacities	
	-	-	-	-	-	Incorrectly isolated valves		Check isolation valves	
	PA31	Pressure sensor	-	-	-	Insufficient customer steam suppy		Increase supply of inlet steam	
	-	-	-	-	-	-		-	
	VA01	Water control valve	Analogue input	0	1	Water control valve stuck open		Inspect water control valve to identify cause	
						Poor PID Settings		Adjust PID settings	

Troubleshooting continued on next page

Alarm number	Alarm PLC tag	Alarm description	Identifier			Fault
			Physical	Process	System	
29	SEC_BAND_LOW_ALARM	Secondary band LOW alarm	No noise/ pump not spinning	No feedwater pressure	Water pump failure alarm	Water supply not sufficient
						Air lock in water pump
						Power loss to pump
						Pump mechanical/ electrical failure
			Valve closed when not instructed	-	Water level low alarm Valve feedback alarm (OPT)	For more information see alarm 60
			Reduced water level on visual boiler sight glass			
			Boiler water being dumped to drain, potential for flash steam			
			Excess Steam coming from drain Water level indicator low Sound from valve	Potential reduced CSG capacity More water consumption	-	Debris/ Wear
Possible reduced pressure on pressure dial	-	-	TDS settings too Low			
			Inlet water supply			
30	SEC_CAP_ALARM	Secondary control capacity alarm	Valve over 99% open	Target clean steam pressure not achieved	Alarm on HMI	Steam demand exceeds CSG capacity
31	SEC_LVL_LOW	Secondary side boiler water level low	Level indicator low	Emergency stop sequence - Ceased production of clean steam	Low water level alarm displayed, Emergency stop displayed on HMI	Water level lower than setpoint
32	SEC_PRES_HI	Secondary side pressurised	Pressure exceeds 0.1 bar g/ 1.45 psi g	-	Emergency Stop displayed on HMI	Service sequence
33	SEC_TEMP_HI	Clean steam temperature hot	Temperature exceeds 40 °C/104 °F	-	-	Temperature exceeds 40 °C/104 °F

	Component					Cause			Action
	TAG number	Item description	Control type	Zone	Instance	Alarm No	ALARM PLC TAG	ALARM DESCRIPTION	
	MB01 MD01	Pump	Analogue output Digital input	0	1	-		Check water supply (Pressure and ensure no debris - Check strainers/ Filters)	
						-		Check air bleed	
						-		Check power status	
						Pump failure		Refer to pump IMI	
	VB01	Supply water control valve	Analogue output	0	1	For more information see Alarm 60		For more Information see alarm 60	
	VE11	Drain valve	Digital output	1	1	Visual inspection		Identify failed part with tag and schematic in IMI. Consult individual product IMI by scanning the QR or following web search. Replace or repair failed part.	
	VE12	TDS control valve	Digital output	1	2	Wear of seat		Identify failed part with tag and schematic in IMI. Consult individual product IMI by scanning the QR or following web search. Replace or repair failed part.	
						Debris in pipeline		Check strainer screen on water inlet. Check for debris origin.	
						TDS valve stuck open		Visit TDS Blowdown section in IMI for details. Check input water conductivity.	
	-	-	-	-	-	Inlet water supply failure		Check inlet water supply for any blockages	
	-	-	-	-	-	Insufficient capacity		Review IMI to check capacities	
	-	-	-	-	-				
	-	-	-	-	-	Isolation valves in service sequence		Check isolation valves	
	-	-	-	-	-				

Troubleshooting continued on next page

Alarm number	Alarm PLC tag	Alarm description	Identifier			Fault
			Physical	Process	System	
34	TA01_ANLG_ALA_OPEN	Feedwater temperature Analog input alarm circuit open	Cables removed from sensor	-	Flashing conductivity readings	Wire removed from sensor
						Sensor failure
						BC3250 controller failure
35	TA01_ANLG_ALA_SHRT	Feedwater temperature Analog input alarm short circuit	Pinched cable from sensor	-	Flashing conductivity readings	Wire pinched or kinked
						Sensor failure
						BC3250 controller failure
36	TA0X_ANLG_ALA_OPEN	Panel temperature analogue input alarm circuit open	Cables removed from sensor	Emergency stop sequence - Ceased production of clean steam	Emergency Stop displayed on HMI/ Flashing conductivity readings	Wire removed from sensor
						Sensor failure
						BC3250 controller failure
37	TA0X_ANLG_ALA_SHRT	Panel temperature analogue input alarm short circuit	Pinched cable from sensor	Emergency stop sequence - Ceased production of clean steam	Emergency Stop displayed on HMI/ Flashing conductivity readings	Wire pinched or kinked
						Sensor failure
						BC3250 controller failure
38	TA0X_HIGH_ALARM	Panel temperature limit alarm		Emergency stop sequence - Ceased production of clean steam	Emergency stop displayed with high panel temperature alarm	High panel temperature
39	TA11_ANLG_ALA_OPEN	Water in temperature Analog input alarm circuit open	Cables removed from sensor	-	Flashing conductivity readings	Wire removed from sensor
						Sensor failure
						BC3250 controller failure
40	TA11_ANLG_ALA_SHRT	Water in temperature Analog input alarm short circuit	Pinched cable from sensor	-	Flashing conductivity readings	Wire pinched or kinked
						Sensor failure
						BC3250 controller failure
41	TA21_ANLG_ALA_OPEN	Clean steam temperature Analog input alarm circuit open	Cables removed from sensor	Emergency stop sequence - Ceased production of clean steam	Emergency Stop displayed on HMI/ Flashing conductivity readings	Wire removed from sensor
						Sensor failure
						BC3250 controller failure
42	TA21_ANLG_ALA_SHRT	Clean steam temperature Analog input alarm short circuit	Pinched cable from sensor	Emergency stop sequence - Ceased production of clean steam	Emergency Stop displayed on HMI/ Flashing conductivity readings	Wire pinched or kinked
						Sensor failure
						BC3250 controller failure

	Component					Cause			Action
	TAG number	Item description	Control type	Zone	Instance	Alarm No	ALARM PLC TAG	ALARM DESCRIPTION	
	TA01	Temperature sensor	Analogue input	0	1	Operator error		Replace cable	
						Refer to technical documentation		Replace sensor	
						Refer to technical documentation		Replace controller	
	TA01	Temperature sensor	Analogue input	0	1	Operator error		Replace cable	
						Refer to technical documentation		Replace sensor	
						Refer to technical documentation		Replace controller	
	TAX1	Temperature of panel	Analogue input	0	1	Operator error		Replace cable	
						Refer to technical documentation		Replace sensor	
						Refer to technical documentation		Replace controller	
	TAX1	Temperature of panel	Analogue input	0	1	Operator error		Replace cable	
						Refer to technical documentation		Replace sensor	
						Refer to technical documentation		Replace controller	
	TAX1	Temperature of panel	Analogue Input	X	1	High ambient temperature		Reduce environment temperature	
	TA11	Temperature sensor	Analogue input	1	1	Operator error		Replace cable	
						Refer to technical documentation		Replace sensor	
						Refer to technical documentation		Replace controller	
	TA11	Temperature sensor	Analogue input	1	1	Operator error		Replace cable	
						Refer to technical documentation		Replace sensor	
						Refer to technical documentation		Replace controller	
	TA21	Temperature sensor	Analogue input	2	1	Operator error		Replace cable	
						Refer to technical documentation		Replace sensor	
						Refer to technical documentation		Replace controller	
	TA21	Temperature sensor	Analogue input	2	1	Operator error		Replace cable	
						Refer to technical documentation		Replace sensor	
						Refer to technical documentation		Replace controller	

Troubleshooting continued on next page

Alarm number	Alarm PLC tag	Alarm description	Identifier			Fault
			Physical	Process	System	
43	TA31_ANLG_ALA_OPEN	Supply steam temperature Analog input alarm circuit open	Cables removed from sensor	-	Flashing conductivity readings	Wire removed from sensor
						Sensor failure
						BC3250 controller failure
44	TA31_ANLG_ALA_SHRT	Supply steam temperature Analog input alarm short circuit	Pinched cable from sensor	-	Flashing conductivity readings	Wire pinched or kinked
						Sensor failure
						BC3250 controller failure
45	TA41_ANLG_ALA_OPEN	Supply waste temperature Analog input alarm circuit open	Cables removed from sensor	-	Flashing conductivity readings	Wire removed from sensor
						Sensor failure
						BC3250 controller failure
46	TA41_ANLG_ALA_SHRT	Supply waste temperature Analog input alarm short circuit	Pinched cable from sensor	-	Flashing conductivity readings	Wire pinched or kinked
						Sensor failure
						BC3250 controller failure
47	TA51_ANLG_ALA_OPEN	Condensate out temperature Analog input alarm circuit open	Cables removed from sensor	-	Flashing conductivity readings	Wire removed from sensor
						Sensor failure
						BC3250 controller failure
48	TA51_ANLG_ALA_SHRT	Condensate out temperature Analog input alarm short circuit	Pinched cable from sensor	-	Flashing conductivity readings	Wire pinched or kinked
						Sensor failure
						BC3250 controller failure
49	TA52_ANLG_ALA_OPEN	Drain temperature analogue input alarm circuit open	Cables removed from sensor	-	Flashing conductivity readings	Wire removed from sensor
						Sensor failure
						BC3250 controller failure
50	TA52_ANLG_ALA_SHRT	Drain temperature analogue input alarm short circuit	Pinched cable from sensor	-	Flashing conductivity readings	Wire pinched or kinked
						Sensor failure
						BC3250 controller failure

	Component					Cause			Action
	TAG number	Item description	Control type	Zone	Instance	Alarm No	ALARM PLC TAG	ALARM DESCRIPTION	
	TA31	Temperature sensor	Analogue input	3	1	Operator error		Replace cable	
						Refer to technical documentation		Replace sensor	
						Refer to technical documentation		Replace controller	
	TA31	Temperature sensor	Analogue input	3	1	Operator error		Replace cable	
						Refer to technical documentation		Replace sensor	
						Refer to technical documentation		Replace controller	
	TA41	Temperature sensor	Analogue input	4	1	Operator error		Replace cable	
						Refer to technical documentation		Replace sensor	
						Refer to technical documentation		Replace controller	
	TA41	Temperature sensor	Analogue input	4	1	Operator error		Replace cable	
						Refer to technical documentation		Replace sensor	
						Refer to technical documentation		Replace controller	
	TA51	Temperature sensor	Analogue input	5	1	Operator error		Replace cable	
						Refer to technical documentation		Replace sensor	
						Refer to technical documentation		Replace controller	
	TA51	Temperature sensor	Analogue input	5	1	Operator error		Replace cable	
						Refer to technical documentation		Replace sensor	
						Refer to technical documentation		Replace controller	
	TA52	Temperature sensor	Analogue input	5	2	Operator error		Replace cable	
						Refer to technical documentation		Replace sensor	
						Refer to technical documentation		Replace controller	
	TA52	Temperature sensor	Analogue input	5	2	Operator error		Replace cable	
						Refer to technical documentation		Replace sensor	
						Refer to technical documentation		Replace controller	

Troubleshooting continued on next page

Alarm number	Alarm PLC tag	Alarm description	Identifier			Fault
			Physical	Process	System	
51	TDS_HI	TDS failure	-	High levels of conductivity	TDS alarm displayed	TDS set point exceeded
			-			Invalid time duration entry
52	TDS_HYS_FAIL	TDS hysteresis fault	Continous Blowdown	-	TDS hystersis alarm displayed	TDS hystersis setpoint not achieved
54	TRAP_FAIL_CLOSE	Trap failure close	Cold before trap, steam collapse/ waterhammer on start up (noise at primary inlet)	Startup not acieved	No alarm	No steam in heat excahnger to heat water
			-	Rapid loss of clean steam pressure	Trap Failed Closed Alarm on HMI	Rapid build-up of condensate
55	TRAP_FAIL_OPEN	Trap Failure Open	High temperature/ WaterHammer/ Pressurised Condensate return system	Increase in Supply water temperature and pressure	Trap Fail open alarm displayed on HMI	Condensate travelling uncontrolled through trap
			Increase in steam consumption	Pressurised condensate return system		
56	VA01_ANLG_ALA_OPEN	Water level control valve feedback Analog input alarm circuit open	Cables removed from sensor	-	Flashing conductivity readings	Wire removed from sensor
						Sensor failure
						BC3250 controller failure
57	VA01_ANLG_ALA_SHRT	Water level control valve feedback Analog input alarm short circuit	Pinched cable from sensor	-	Flashing conductivity readings	Wire pinched or kinked
						Sensor failure
						BC3250 controller failure
58	VA31_ANLG_ALA_OPEN	Supply steam in control valve feedback Analog input alarm circuit open	Cables removed from sensor	-	Flashing conductivity readings	Wire removed from sensor
						Sensor failure
						BC3250 controller failure
59	VA31_ANLG_ALA_SHRT	Supply steam in control valve feedback Analog input alarm short circuit	Pinched cable from sensor	-	Flashing conductivity readings	Wire pinched or kinked
						Sensor failure
						BC3250 controller failure

	Component					Cause			Action
	TAG number	Item description	Control type	Zone	Instance	Alarm No	ALARM PLC TAG	ALARM DESCRIPTION	
	VE12	TDS valve	Digital output	1	2	TDS set point exceeded			Take action to reduce TDS, if necessary adjust setpoint Visit TDS blowdown section in IMI for details
						Input error on HMI			
	VE12	TDS valve	Digital output	1	2	Input error on HMI			Adjust setpoint whilst referring to IMI
						Partially blocked valve			Inspect blocked valve
						Restrictions in blowdown			Inspect any blockages in blowdown
	QU51	Steam trap	Uncontrolled	5	1	Blockage in condensate line during start-up			Identify blockages
						Blockage in condensate line during operation			
	QU51	Steam trap	Uncontrolled	5	1	Wear of seat Debris in pipeline			Identify failed part with tag and schematic in IMI. Consult individual product IMI by scanning the QR or following web search. Replace or repair failed part.
	VA01	Feedwater control valve	Analogue input	0	1	Operator error			Replace cable
						Refer to technical documentation			Replace sensor
						Refer to technical documentation			Replace controller
	VA01	Feedwater control valve	Analogue input	0	1	Operator error			Replace cable
						Refer to technical documentation			Replace sensor
						Refer to technical documentation			Replace controller
	VA31	Plant steam control valve	Analogue input	3	1	Operator error			Replace cable
						Refer to technical documentation			Replace sensor
						Refer to technical documentation			Replace controller
	VA31	Plant steam control valve	Analogue input	3	1	Operator error			Replace cable
						Refer to technical documentation			Replace sensor
						Refer to technical documentation			Replace controller

Troubleshooting continued on next page

Alarm number	Alarm PLC tag	Alarm description	Identifier			Fault		
			Physical	Process	System			
60	VB01_FBK	Feedwater control feedback error	Valve not open when instructed.	-	Valve feedback alarm (OPT), Water level failure alarm, Water level high alarm	Leaking seat/ plug		
						Positioner failure		
						Positioner calibration faulty		
								Actuator failure
			Valve closed when instructed.	Potential reduced CSG capacity. More water consumption	Water Level Low alarm, Valve feedback alarm (OPT)	Mechanically failed shut		
						Positioner failure		
						Actuator failure		
			Gauling Valve		Valve feedback alarm (OPT), Water level failure alarm, Water level high alarm	Valve failure		
						Positioner failure		
61	VB31_FBK	Steam in control feedback error	Valve not open when instructed.	-	Valve feedback alarm (OPT), Water level failure alarm, Water level high alarm	Leaking seat/ plug		
						Positioner failure		
						Positioner calibration faulty		
								Actuator failure
			Valve closed when not instructed	Potential reduced CSG capacity. More water consumption	Water Level Low alarm. Valve feedback alarm (OPT)	Mechanically failed shut		
						Positioner failure		
						Actuator failure		
			Gauling valve		Valve feedback alarm (OPT), Water level failure alarm, Water level high alarm	Valve failure		
						Positioner failure		

	Component					Cause			Action
	TAG number	Item description	Control type	Zone	Instance	Alarm No	ALARM PLC TAG	ALARM DESCRIPTION	
	VA01	Feedwater control valve	Analogue input	0	1	Wear of seat			Identify failed part with tag and schematic in IMI. Consult individual product IMI by scanning the QR or following web search. Replace or repair failed part.
						Debris in pipeline			Check strainer screen on water inlet. Check for debris origin.
						Mismatch between positioner and PLC			Identify failed part with tag and schematic in IMI. Consult individual product IMI by scanning the QR or following web search. Replace or repair failed part.
						Mismatch between positioner and actual stem indicator position and PLC			
						Mismatch between positioner and actual stem indicator position and PLC			
						Gailing of stem			
						Mismatch between positioner and PLC			
						Mismatch between positioner and actual stem indicator position and PLC			
						Gailing/ Wear of stem			
						Mismatch between positioner and PLC			
	VA01	Feedwater control valve	Analogue input	0	1	Wear of seat			Identify failed part with tag and schematic in IMI. Consult individual product IMI by scanning the QR or following web search. Replace or repair failed part.
						Debris in pipeline			Check strainer screen on water inlet. Check for debris origin.
						Mismatch between positioner and PLC			Identify failed part with tag and schematic in IMI. Consult individual product IMI by scanning the QR or following web search. Replace or repair failed part.
						Mismatch between positioner and actual stem indicator position and PLC			
						mismatch between positioner and actual stem indicator position and PLC			
						Gailing of stem			
						Mismatch between positioner and PLC			
						Mismatch between positioner and actual stem indicator position and PLC			
						Gailing/ Wear of stem			

Troubleshooting continued on next page

Alarm number	Alarm PLC tag	Alarm description	Identifier			Fault
			Physical	Process	System	
62	WASTE_TEMP_HI	Waste steam temperature hot	Temperature exceeds 40 °C/104 °F	Service sequence halted	-	Service sequence
63	WATER_PUMP_FAIL	Water pump failure	No Sound from water pump	Reduced output of clean steam	Alarm displayed on HMI	Power loss to pump
						Water supply not sufficient
						Air lock in water pump
						Pump mechanical/ electrical failure
64	WATER_TEMP_HI	Water in temperature hot	Temperature exceeds 40 °C/104 °F	Service sequence halted	Alarm displayed on HMI	Service sequence
66	SEC_PRES_LIM	Secondary high pressure limit alarm	-	Emergency Stop Sequence- Ceased production of clean steam	Emergency stop displayed on HMI	Control issue
67	INITIALISE	PLC Start-up from power cycle	-	No Clean Steam Produced/CSG not operational	No display on HMI or partial display	Faulty PLC
68	WATER_LVL_HI	Water level high alarm	Water Level exceeds 90%	Inaccurte control of water control valve	Alarm displayed on HMI	Water level exceeds 90%
				Water control valve failed open		
69	WATER_LVL_ALARM	Water level failure	TDS Valve opening outside of TDS control	-	Alarm displayed on HMI	Repeated high water level alarm on HMI
70	AIR_PRESS_FAIL	Air supply pressure fail	No valve movement	-	Alarm displayed on HMI	Insufficient Compressed Air
71	VE31_FAIL_OPEN	Plant isolation valve fail open	-	Start-up/ Shutdown sequence would halt	Alarm displayed on HMI	Leaking seat
			Actuator Indicator in incorrect Position			Actuator failure
72	VE31_FAIL_CLOSE	Plant isolation valve fail closed	Indicator displays closed when instructed to open	CSG does not start/ Loss of clean steam supply	Alarm displayed on HMI	Valve does not leave closed position when instructed

	Component					Cause			Action
	TAG number	Item description	Control type	Zone	Instance	Alarm No	ALARM PLC TAG	ALARM DESCRIPTION	
	-	-	-	-	-	Insufficient isolation during servicing			Work and check isolation valves
	MB01 MD01	Pump	Analogue output Digital input	0	1	-			Check power status
						Insufficient water head pressure			Check water supply (Ensure no debris, checking strainers and filters along with the pressure)
						Insufficient bleeding			Check air bleed
						-			Refer to pump IMI - Suspect pump internal failure
	-	-	-	-	-	Insufficient isolation during servicing			Work and check isolation valves
	LD11	Level switch	Digital input	1	1	-			Check settings on pressure switch.
	-	-	-	-	-	PLC failure			Contact SXS engineer
	VA01	Feedwater control valve	Analogue input	0	1	65	WATER_VLV_FAIL	Water control valve failure	Inaccurte control of water control valve
						65	WATER_VLV_FAIL	Water control valve failure	Water control valve failed open
	-	-	-	-	-	See Alarm 68 for more information			See Alarm 65 for more Information
	PDX1	Air supply	Digital input	0	1	-			Restore air supply
	VE31	Steam isolation valve	Digital output	3	1	Wear of seat			Identify failed part with tag and schematic in IMI. Consult individual product IMI by scanning the QR or following web search. Replace or repair failed part.
						Debris in pipeline			Check strainer screen on water inlet. Check for debris origin.
	VE31	Steam isolation valve	Digital output	3	1	Insufficient customer air supply			Check customers air supply line
	VE31	Steam isolation valve	Digital output	3	1	Mismatch between positioner and actual stem indicator position and PLC			Identify failed part with tag and schematic in IMI. Consult individual product IMI by scanning the QR or following web search. Replace or repair failed part.

Troubleshooting continued on next page

Alarm number	Alarm PLC tag	Alarm description	Identifier			Fault
			Physical	Process	System	
73	VE31_FAIL_STICK	Plant isolation valve fail stuck	Actuator indicator shows neither on/off	Start-up/ Shutdown sequence would halt	Alarm displayed on HMI	Leaking seat
						Actuator failure
74	VE31_FAIL_SPEED	Inlet Plant valve fail opening speed	Possible waterhammer in primary side	-	Alarm displayed on HMI	Unrestricted exhaust flow from actuator
75	VE21_FAIL_OPEN	Outlet isolation valve fail open	-	Start-up/ Shutdown sequence would halt	Alarm displayed on HMI	Leaking seat
			Actuator Indicator in incorrect position			Actuator failure
76	VE21_FAIL_CLOSE	Outlet isolation valve fail closed	Indicator displays closed when instructed to open	CSG does not start/ Loss of clean steam supply	Alarm displayed on HMI	Valve does not leave closed position when instructed
77	VE21_FAIL_STICK	Outlet isolation valve fail stuck	Actuator indicator shows neither on/off	Start-up/ Shutdown sequence would halt	Alarm displayed on HMI	Leaking seat
						Actuator failure
78	VE21_FAIL_SPEED	Outlet isolation valve fail opening speed	Waterhammer	Sudden/ rapid pressure loss Risk of carryover	Alarm displayed on HMI	Unrestricted exhaust flow from actuator

	Component					Cause			Action
	TAG number	Item description	Control type	Zone	Instance	Alarm No	ALARM PLC TAG	ALARM DESCRIPTION	
	VE31	Steam isolation valve	Digital output	3	1	Wear of seat		Identify failed part with tag and schematic in IMI. Consult individual product IMI by scanning the QR or following web search. Replace or repair failed part.	
Debris in pipeline						Check strainer screen on water inlet. Check for debris origin.			
Insufficient customer air supply						Check customers air supply line			
	VE31	Steam isolation valve	Digital output	3	1	Exhaust restrictor set incorrectly		Reset/ Replace exhaust restrictor	
	VE21	Steam isolation valve	Digital output	2	1	Wear of seat		Identify failed part with tag and schematic in IMI. Consult individual product IMI by scanning the QR or following web search. Replace or repair failed part.	
Debris in pipeline						Check strainer screen on water inlet. Check for debris origin.			
Insufficient customer air supply						Check customers air supply line			
	VE21	Isolation valve	Digital output	2	1	Mismatch between positioner and actual stem indicator position and PLC		Identify failed part with tag and schematic in IMI. Consult individual product IMI by scanning the QR or following web search. Replace or repair failed part.	
	VE21	isolation valve	Digital output	2	1	Wear of seat		Identify failed part with tag and schematic in IMI. Consult individual product IMI by scanning the QR or following web search. Replace or repair failed part.	
Debris in pipeline						Check strainer screen on water inlet. Check for debris origin.			
Insufficient customer air supply						Check customers air supply line			
	VE21	isolation valve	Digital output	2	1	Exhaust restrictor set incorrectly		Reset/ Replace exhaust restrictor	

Troubleshooting continued on next page

Alarm number	Alarm PLC tag	Alarm description	Identifier			Fault
			Physical	Process	System	
81	PRI_BAND_HI_ALERT	Primary band high alert	-	High clean stem pressure	Alert displayed on HMI	Failed open control valve
						Leaking control valve
						Leak in heat exchanger
						PID settings
82	PRI_BAND_LOW_ALERT	Primary band low alert	Control valve closed for a given amount of time	Low clean steam pressure	Alert displayed on HMI	Valve positioning incorrect
						PID settings
						Customer supply steam
						Restricted condensate flow
83	PRI_CAP_ALERT	Primary control capacity alert	Valve over 99% open for a given amount of time	-	Alert displayed on HMI	Plant steam
						Capacity incorrect
						Restricted condensate flow
84	SEC_BAND_HI_ALERT	Secondary band high alert	-	Possible carryover	Alert displayed on HMI	PID settings
						Leaking valve
85	SEC_BAND_LOW_ALERT	Secondary band low alert	-	-	Alert displayed on HMI	Positioner failure
						PID settings
86	SEC_CAP_ALERT	Secondary control capacity alert	-	-	Alert displayed on HMI	Insuffiecnt water supply

	Component					Cause			Action
	TAG number	Item description	Control type	Zone	Instance	Alarm No	ALARM PLC TAG	ALARM DESCRIPTION	
						See alarm 71 for more information		See Alarm 71 for more Information	
						-		Identify leak in control valve	
						-		Identify leak in heat exchanger	
						Incorrect PID settings		Adjust PID setting if necessary	
	VA31	Steam control valve	Analogue input	3	1	-		Identify failed part with tag and schematic in IMI. Consult individual product IMI by scanning the QR or following web search. Replace or repair failed part.	
						Incorrect PID settings		Adjust PID setting if necessary	
	-	-	-	-	-	-		Fix inlet steam supply	
						Debris in pipeline		Remove debris from pipeline	
	VA31	Plant steam control valve	Analogue input	3	1	Plant steam Insufficient		Fix Plant steam	
						Capacity incorrect		See IMI for correct capacities.	
	-	-	-	-	-	Debris in pipeline		Inspect pipeline and remove any debris	
						Inspect PID settings		Adjust PID settings if necessary	
	-	-	-	-	-	-		Identify failed part with tag and schematic in IMI. Consult individual product IMI by scanning the QR or following web search. Replace or repair failed part.	
						-		Identify failed part with tag and schematic in IMI. Consult individual product IMI by scanning the QR or following web search. Replace or repair failed part.	
						Inspect PID settings		Adjust PID settings if necessary	
	-	-	-	-	-	Debris in pipeline		Remove any debris from pipeline.	

8. Maintenance



Before starting any maintenance operation, carefully read the general safety information in Section 1 of this document.

Before starting any installation or maintenance operation, make sure that power has been shut-off.

To carry out many maintenance procedures, the unit shall be isolated from the system. The unit can be re-inserted in the system only after completing all the procedures.

It is recommended that maintenance personnel carry out the shut-down and start-up procedures described in this manual.

8.1 General information

The maintenance of single system components must be carried out as indicated in the individual installation and maintenance manuals (IM).

8.2 Inspection/replacement of the tube bundle of the generator

The U-shaped tube bundle is the core of the steam generator. It must be removed and inspected every two years or as established by the terms of the warranty. The plate of the tube bundle is secured between the flanges of the vessel of the generator and the primary steam head. It is fitted with two gaskets:

- 1 shell side of the generator, between the tube bundle plate and body/shell of the generator.
- 1 head side (2-passes), between the tube bundle plate and primary steam head.

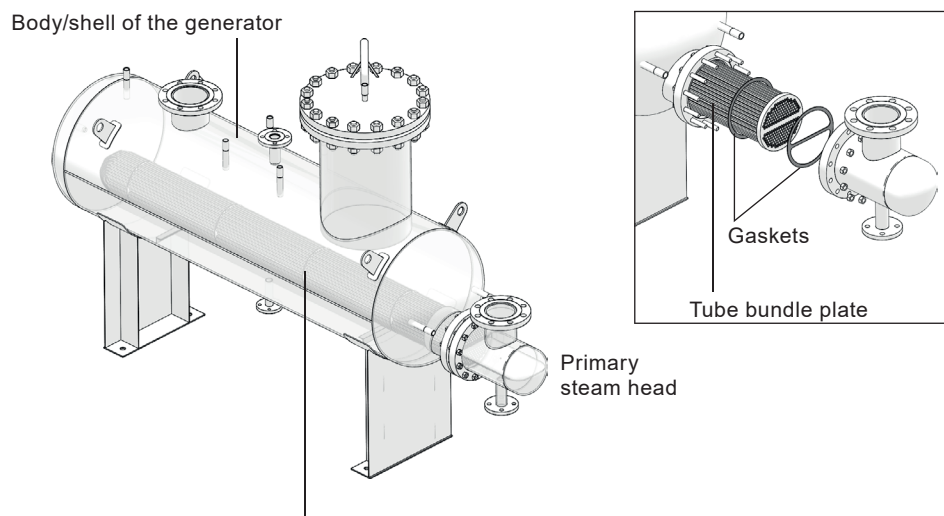

Fig. 8 "U" shaped tube bundle

8.2.1 Disassembly of the tube bundle:

- Check that primary steam, condensate return line, feedwater inlet and clean steam outlet are isolated; that both circuits (primary and secondary) are not pressurized; that the generator has been completely drained and all components and surfaces are cold.
- Carefully remove the insulation from the header of the generator unscrewing the bolts on the aluminium cladding
- Carefully disconnect the piping between the head of the generator and the primary steam inlet and condensate blowdown lines, with the utmost care so that no part of the line has damage.
- Separate the head from the generator, removing the bolts that secure it to the body.
- Carefully pull the tube bundle and hold it with the proper mechanical equipment slightly raised above the lower rim of the body flange, allowing a correct extraction without interferences.

8.2.2 Inspection of the tube bundle:

- Inspect the tube bundle for scale and/or leaks. In the absence of leaks, remove scale and carefully clean the tube bundle before preparing this for installation.
- If detected, even a leakage, repair or replace the tube bundle.

8.2.3 Re-assembly of the tube bundle:

- Remove the old gaskets, thoroughly clean mating surfaces and install two new gaskets: one between the tube plate and generator (shell side), the other with the sector divider between the tube plate and the head (head side).
- Carefully insert the tube bundle in the generator body, so that the dividing line between the two passes of the tubes is perfectly parallel to the horizontal plane.
- After making sure that the tube is properly in place, assemble the primary steam head by aligning the divider at the dividing line between the two passes of the tubes (expected perfectly parallel to the horizontal plane), then tighten the bolts.
- Reconnect the inlet and outlet primary lines to the steam head. Check that these have been reconnected also where they may have been detached to facilitate extraction of the tube bundle.
- Carefully check all connections to detect any leaks during start-up.

8.3 Inspection/replacement of the deaerator

The deaerator must be removed and inspected every two years or as established by the terms of the warranty.

8.3.1 Disassembly of the deaerator:

- Check that primary steam, condensate return line, feedwater inlet, NCG vent and clean steam outlet are isolated; that both circuits (primary and secondary) are not pressurized; that the generator has been completely drained and all components and surfaces are cold.
- Carefully disconnect the piping between the head of the deaerator and the feedwater line, the utmost care so that no part of the line has damage.
- Separate the deaerator head from the generator, removing the bolts that secure it to the generator shell.
- Carefully lift the deaerator inner part securing it from the installed eyebolts.
- Unscrew the four bolts that secure the plates assembly to the external shield and carefully remove the plates assembly from it.

8.3.2 Inspection of the deaerator:

- Inspect the deaerator plates for scale and/or holes, remove scale and carefully clean the plates.
- If major fault detected, repair or replace the plate or the deaerator cartridge.

8.3.3 Re-assembly of the deaerator:

- Remove the old gasket, thoroughly clean mating surfaces and install a new gasket.
- Re-assemble the deaerator cartridge, securing the shield to the plates assembly through the four bolts installed.
- Carefully insert the deaerator cartridge in the generator body, aligning the corresponding eyebolts.
- After making sure that the deaerator is properly in place, assembly the cap by aligning the eye bolts, then tighten the bolts (as indicated in Appendix at the back of this document).
- Reconnect the feedwater and the NCG lines to the deaerator cap. Check that these have been reconnected also where they may have been detached to facilitate extraction of the deaerator.
- Carefully check all connections to detect any leaks during start-up.

8.4 Inspection/Replacement of the pressure safety switch

The safety pressure switch acts as a fail-safe for Spirax Sarco Clean Steam Generators. The alarm and shut down for high pressure is set at a value lower than the set of the safety valve. If the pressure safety switch mounted on the tank is not functioning correctly and must be replaced, follow the procedures outlined below.

8.4.1 Disassembly of the pressure switch:

- Follow the shutdown procedure to take the unit off-line before attempting to replace the safety pressure switch.
- Turn off/disconnect all electric power before attempting any maintenance procedures.
- Check that primary steam, condensate return line, feedwater inlet, NCG vent and clean steam outlet are isolated; that both circuits (primary and secondary) are not pressurized; that the generator has been completely drained and all components and surfaces are cold.
- Carefully Disconnect the wires leading from/to the control cabinet.
- Loosening the connections until the pressure probe can be removed.

8.4.2 Inspection of the pressure switch:

- Examine the probes for damage or incorrect positioning. For the exact procedure for examination refer to the Spirax Sarco manual information included with the unit.

8.4.3 Re-assembly of the pressure switch:

- To install a new unit follow recommendations contained in the manufacturer's documentation.
- After ensuring that the unit is correctly installed, tighten the fittings.
- Follow the start-up procedures to put the unit back on-line. Carefully check all connections for any sign of leakage.

8.5 Replacement of the Pressure Safety Valve (Generator)

The pressure safety valve acts as a fail-safe for Spirax Sarco Compact Steam Generators. The valve will open for high pressure to protect the system from explosion. If the pressure safety valve mounted on the pressure vessel is not functioning correctly and must be replaced, follow the procedures outlined below.

8.5.1 Disassembly of the safety valve:

- Follow the shutdown procedure to take the unit off-line before attempting to replace the safety pressure switch.
- Turn off/disconnect all electric power before attempting any maintenance procedures.
- Check that primary steam, condensate return line, feedwater inlet, NCG vent and clean steam outlet are isolated; that both circuits (primary and secondary) are not pressurized; that the generator has been completely drained and all components and surfaces are cold.
- After assuring that the pressure has been relieved from the tank, disconnect the vent line leading from the pressure relief valve to atmosphere (usually through the roof), and via a drip elbow, to drain.
- Carefully disconnect the pressure relief valve from between the generator vessel and feed tank.

8.5.2 Re-assembly of the pressure switch:

- Install the new valve. Follow recommendations contained in the manufacturer's documentation, local codes, or accepted contractor practices as to the use of joint compound or sealer at the connections.
- Reconnect the vent line leading from the pressure safety valve to atmosphere and, via drip elbow, to drain.
- Follow the start-up procedures to put the unit back on-line. Carefully check all connections for any sign of leakage.

8.6 Spare parts

For recommended spare parts for commissioning or maintenance, please contact our Service Department.

8.7 Recommend inspection

The following table indicate the suggested interval times for the inspection on the clean steam generator and of all the other components installed on the package.

Inspection	Refer to product IMI	Daily	Weekly	Quarter	** To verify the difference between the measure of the transmittal against the indicator
Blowdown		•			
Control valve	•				
Water level**		•			
Pressure level**				•	
Level control	•				
Inlet and outlet line				•	
Pneumatic connections				•	
Electrical connection				•	
Primary and secondary side pressure		•			
Safety valve	•				
Manual isolation valve			•		
Strainers				•	

8.8 Spirax Sarco Service maintenance

Spirax Sarco can provide on request of routine scheduled maintenance contract with the following steps. The maintenance contract usually includes two visits per year.

Maintenance Test	6 month visit	12 month visit	18 month visit	24 month visit
Dismantle control valve, clean and visually inspect valve internals		•		•
Visual inspection of controller, valve and actuator	•	•	•	•
Visual inspection of all wiring and terminations	•	•	•	•
Check all electrical connections for tightness	•	•	•	•
Replace valve stem seals			•	
Check valve/actuator/positioners, zero and stroke, adjust if necessary	•		•	
Ensure correct operation pump (if present)		•		•
Pressure transmittal and level transmittal control		•		•
Functional inspection of safety components and PLC			•	•
Visually inspect of heat exchanger for external leakage	•	•	•	•
Tube bundle dismantled and inspection, gasket replacement				•
Deareator dismantled and inspection, gasket replacement				•
Preheater heat exchanger inspection (if present)				•
Check and clean all strainer screens, re-fit using new cap gaskets	•	•		•
TDS test and probe check	•	•	•	•
TDS re-calibration				•
Fully functional test of the unit	•	•	•	•

9. Component map

The Components detailed below may not be fitted to all versions of the CSG-HS. Refer to section 9.2 for Component configuration lists. Optional items are designated with *.

9.1 System P&ID

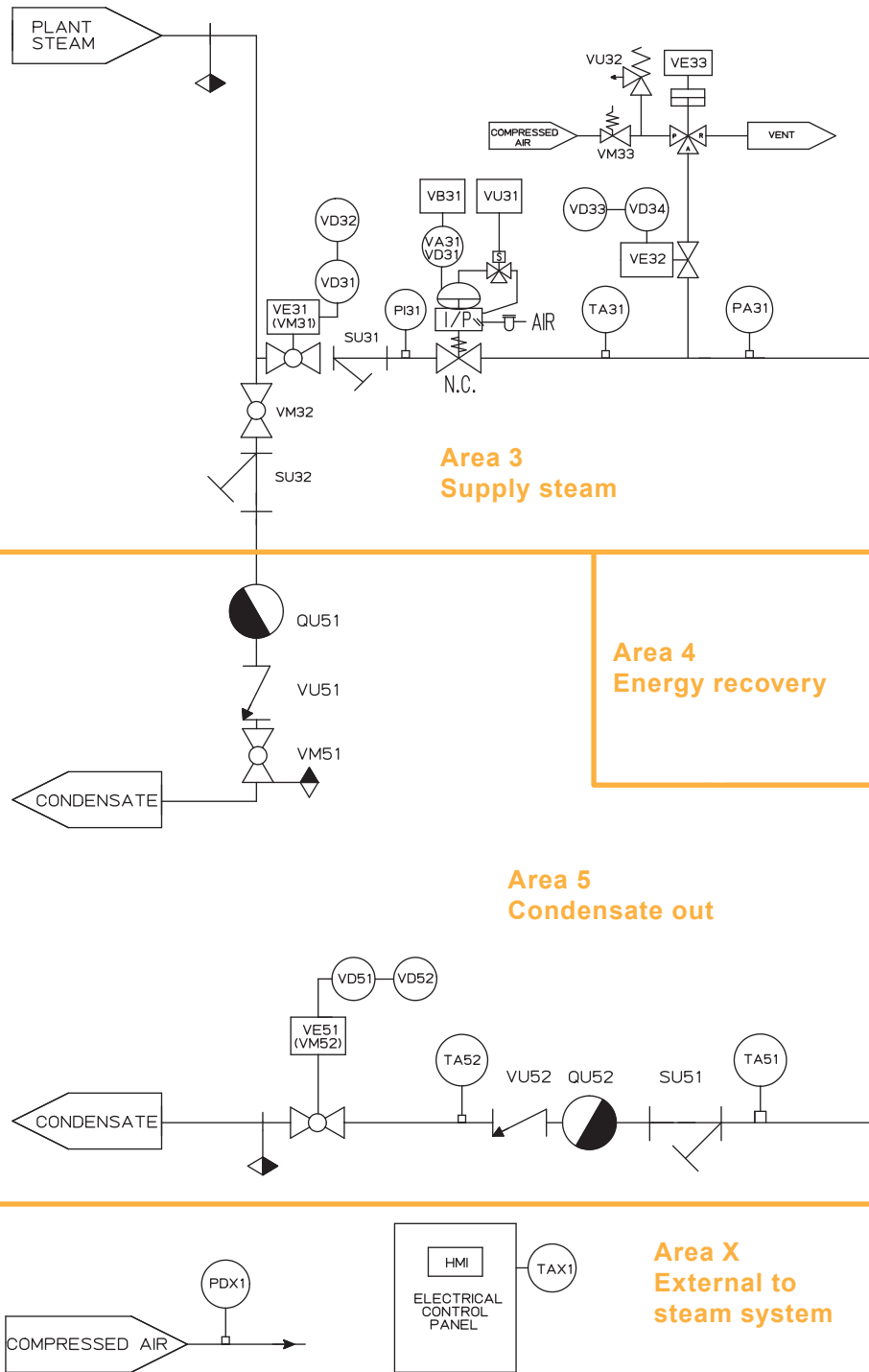
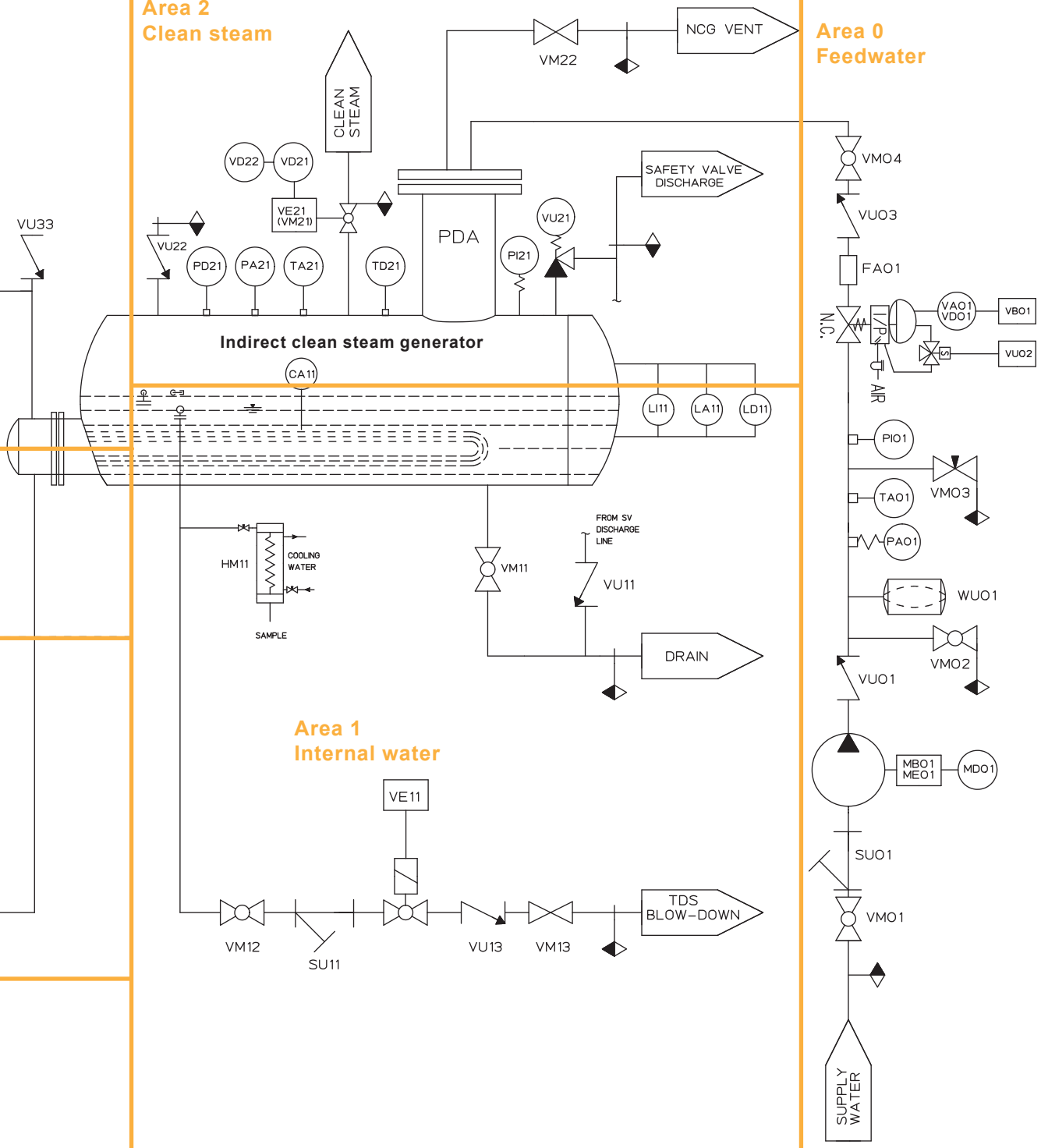

Fig. 9

**Area 2
Clean steam**

**Area 0
Feedwater**



9.2 Component Configuration

The options available for the CSG-HS are listed in section 2.3. Many of the available options will utilise additional equipment fitted the system. The components specifically required for each option are listed below. Default items fitted as standard are identified with*

Plant steam inlet isolation valve

- Manual valve*: VM31
- Automated valve: VM31 replaced by VE31, VD31, and VD32

TDS control system

- Timer control*: VE11
- Pulsed and continuous hysteresis control: VE12 and CA11

Feedwater pressurisation system

- None*
- Integrated pump: MA01. MD01

Independent downstream plant protection

- None*
- Low level limit switch: LD11
- Saturated temperature limit switch: TD21

Intelligent Diagnostics

- None*
- Integrity test: VM51 replace by VE51, VM11 replace by VE11, PA31, TA31, VE32, VE33
- Performance monitoring: TA01. TA21, TA31, TA51, TA52, FA01, PA31 and PA01
- System diagnostics: VB01, VB31, PA31, TA51 and TA52
 - With pneumatic control or Integrity test: PDX1
 - Without integrated pump: PA01

Clean steam outlet isolation valve

- None*
- Manual Valve: VM21
- Automated valve: VE21, VD21 and VD22

9.3 Component naming convention

The naming convention for the system map do not correlate to the specific parts and part numbers. The tag names are specific to the CSG-HS system and are not tied to specific component models. To identify a particular component, reference the component tag number to the Bill Of Materials for the specific model of CSG-HS.

The tag numbers can be deciphered to aid identification and location of the component on the CSG-HS.

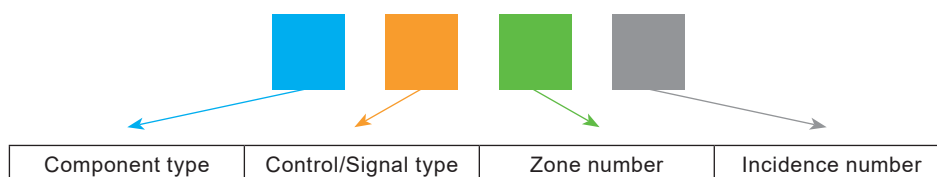

9.3.1 Component types

Opposite is a table of currently identified component types.

Letter	Component type
C	Conductivity
F	Flow sensor
H	Heat exchanger (preheater, sample cooler, etc)
L	Level sensor
P	Pressure sensor
Q	Trap (steam, air eliminator, etc)
S	Separator
T	Temperature sensor
V	Valve (globe, ball, check, vacuum breaker, butterfly, etc)
W	Water vessel (pressure buffer, storage, etc)
Y	Strainer

9.3.2 Control/signal type

Opposite is a table of currently identified Control and Signal types. The direction of signals is always reference in relation to the PLC or process controller.

Letter	Control/Signal type
A	Analogue input (signal)
B	Analogue output (control)
D	Digital input
E	Digital output
I	Indicator (non-electrical, dial, etc)
M	Manual control
U	Un-controlled (check valve, strainer, separator, etc)

9.3.3 Zone allocation

Zones are used to segregate areas of the package into sub-areas based around state changes of the process of the package.

Numbering of the Zones begins with the inlet flow of the process fluid at Zone 0. When the process fluid undergoes a change or state change, the Zone number increases until it leaves the CSG-HS.

The inlet of the control fluid begins with the next available Zone number. At each state change of the control fluid, increase the Zone number until the control fluid leaves the package.

Components located externally to the steam system are always labelled as Zone X.

9.3.4 Incidence number

Where multiples of similar devices and parts occur in the same zone, incidence numbers are used to distinguish between them.

Starting points for incidence numbers always start from the component closest the entry of the Zone area.

e.g. On a condensate line, 2 manual valves are identified in Zone 5. The first of the manual valves to come into contact with the condensate as it passes through zone 5 will be given the Incidence number 1.

10. HMI map

The following map shows the screens available to all users. Some screens will require a security password to access. The minimum required level is highlighted with the Key shown opposite.

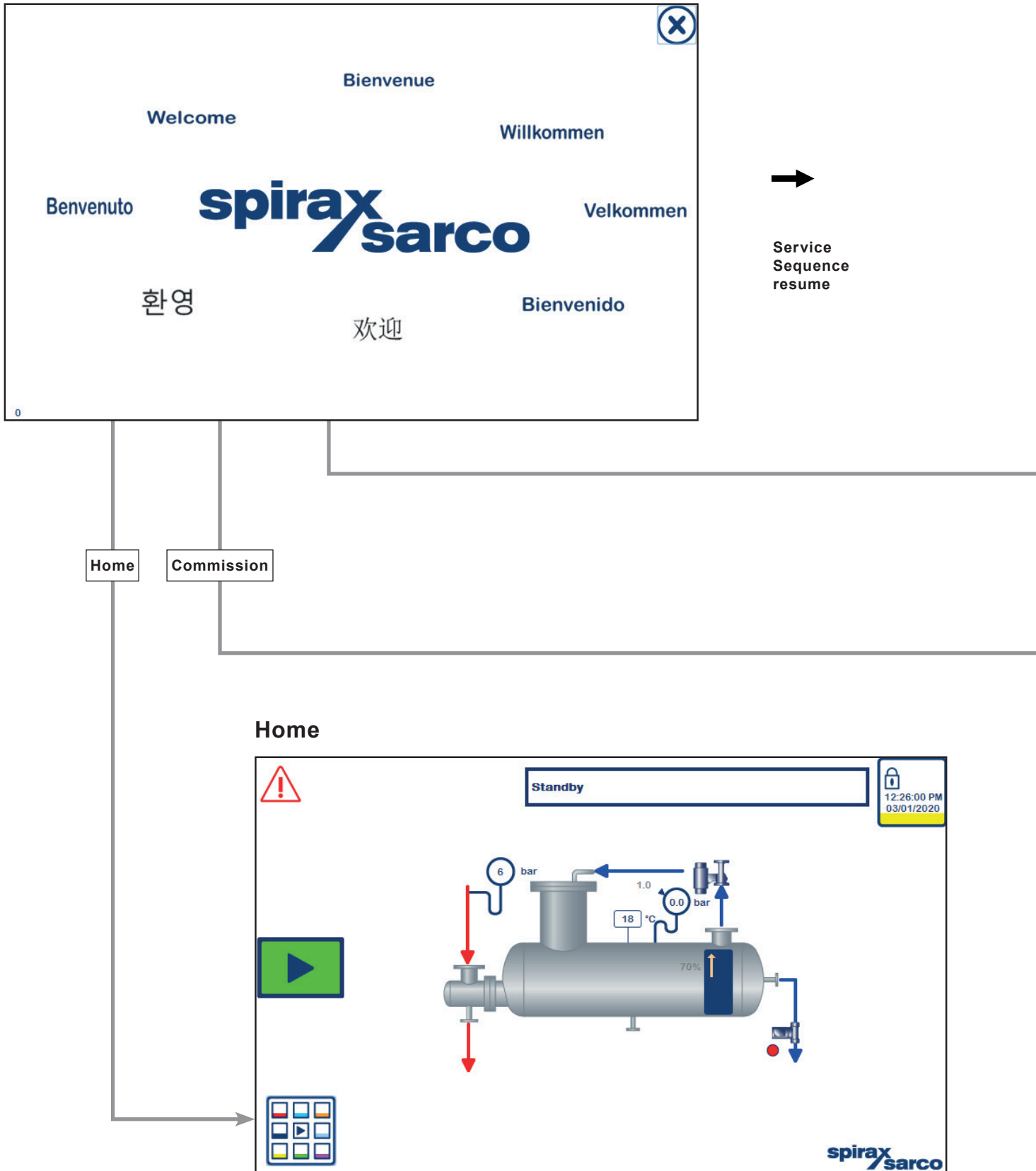

Level key

1 Level 1: Customer User

2 Level 2: Customer engineer

3 Level 3: Spirax Sarco engineer

Pre-commission alarm

Active Alarms

No.	Time	Text
13	03:50:23 PM	Water level analogue input alarm circuit open
9	03:50:23 PM	Feedwater flow rate analogue input alarm circuit open
5	03:50:23 PM	Water conductivity analogue input alarm circuit open
20	03:50:23 PM	Supply steam in pressure analogue input alarm circuit open
18	03:50:23 PM	Clean steam pressure analogue input alarm circuit open
47	03:50:23 PM	Condensate out temperature analogue input alarm circuit open
45	03:50:23 PM	Condensate temperature analogue input alarm circuit open
43	03:50:23 PM	Supply steam temperature analogue input alarm circuit open
41	03:50:23 PM	Clean steam temperature analogue input alarm circuit open
38	03:50:23 PM	Panel temperature limit alarm
36	03:50:23 PM	Panel temperature analogue input alarm circuit open
34	03:50:23 PM	Feedwater temperature analogue input alarm circuit open
58	03:50:23 PM	Supply steam control valve feedback analogue input alarm
56	03:50:23 PM	Water level control valve feedback analogue input alarm
49	03:50:23 PM	Drain temperature analogue input alarm circuit open
77	03:50:23 PM	Clean steam isolation valve fail stuck

⏪

⏩

Commission

Select language

⏪

⏩

10

10.1 Commissioning screens

The commissioning screens allow users to input the configuration of the CSG-HS into the control system using the model specific nomenclature. These are generated at the point of ordering and must be referenced to ensure correct operation of the CSG-HS.

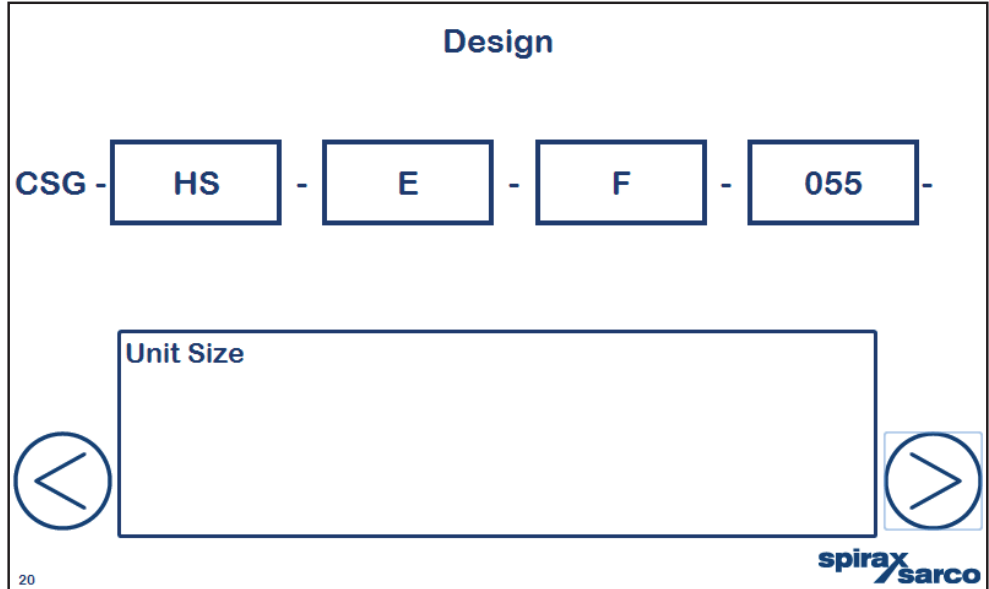

Design

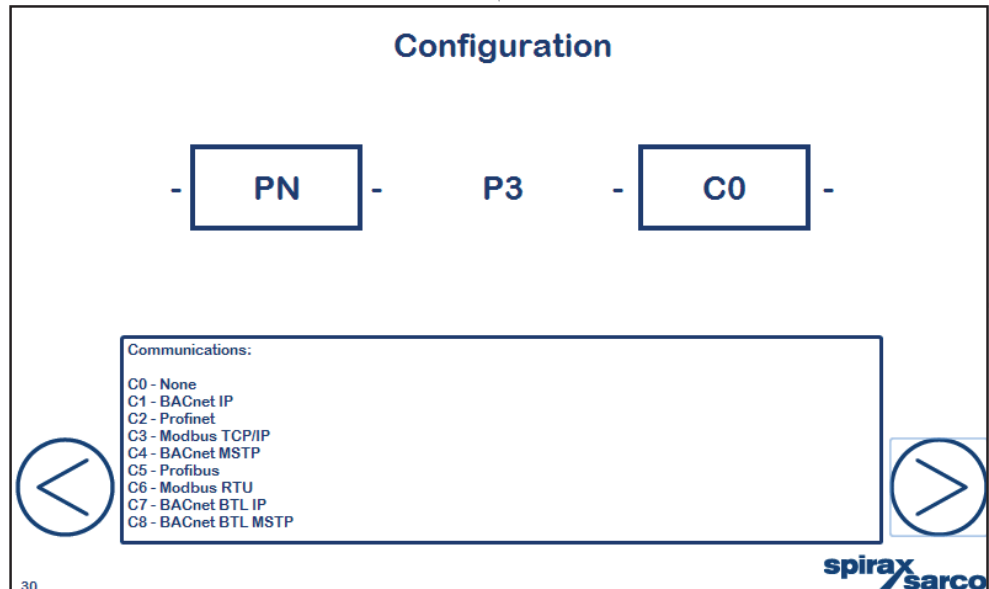

Configuration

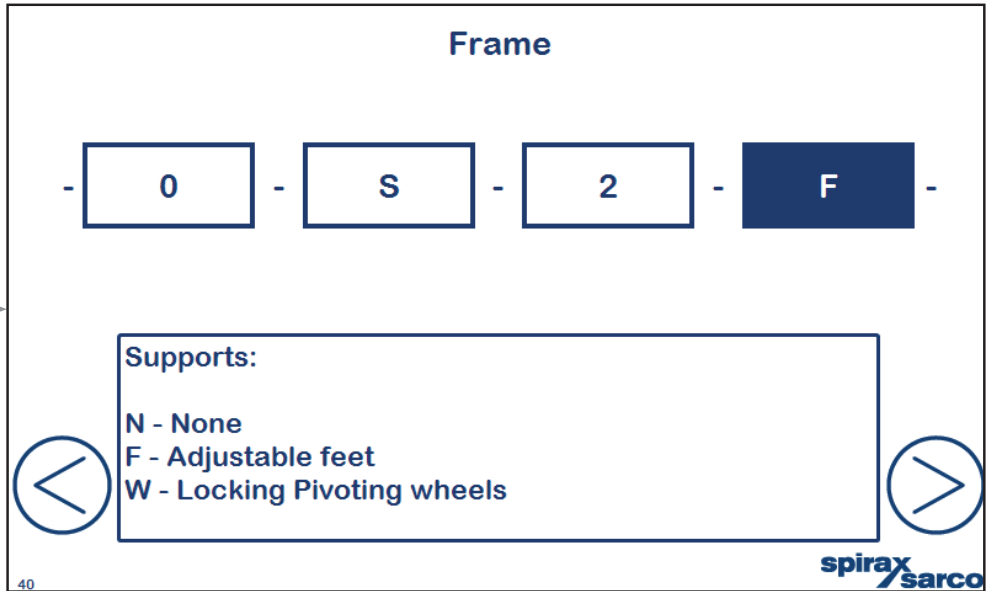

40
Frame

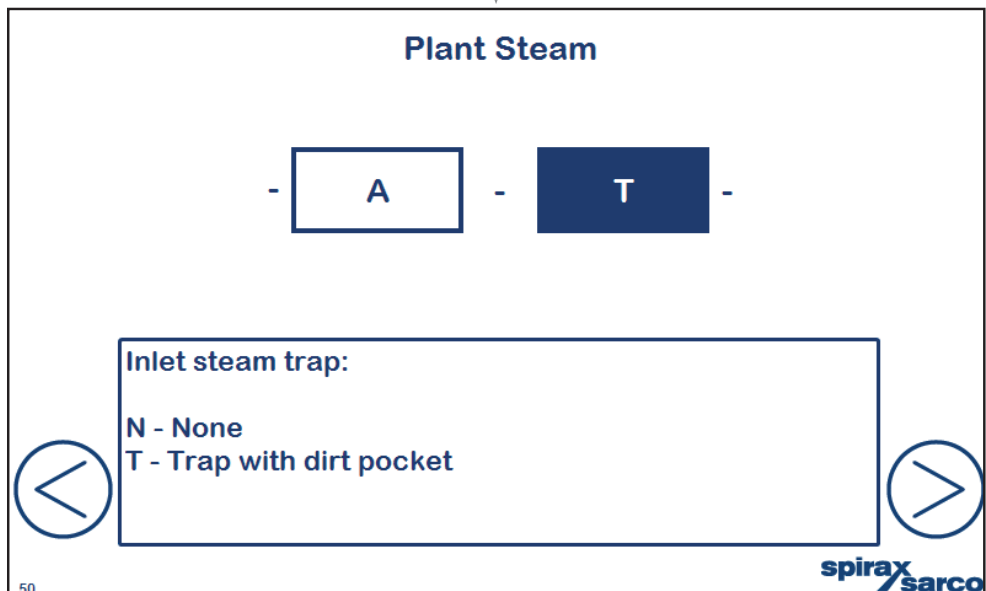

50
Plant steam

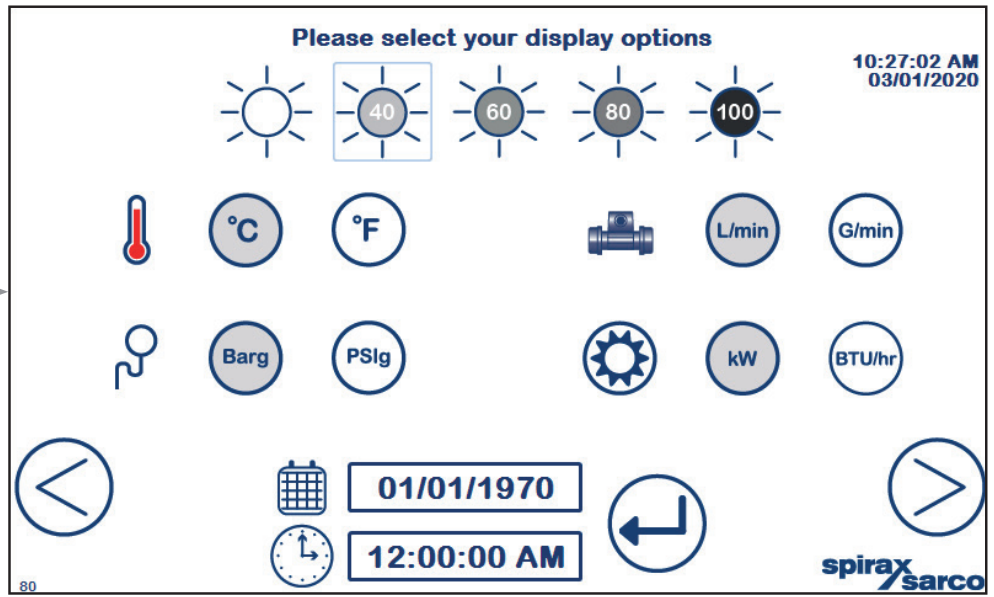

Display settings

10.2 Home screen

The home screen (100) gives the user the ability to quickly view the essential parameters and run status of the CSG-HS. Additionally, more detailed parameters and process values are quickly and easily accessible.

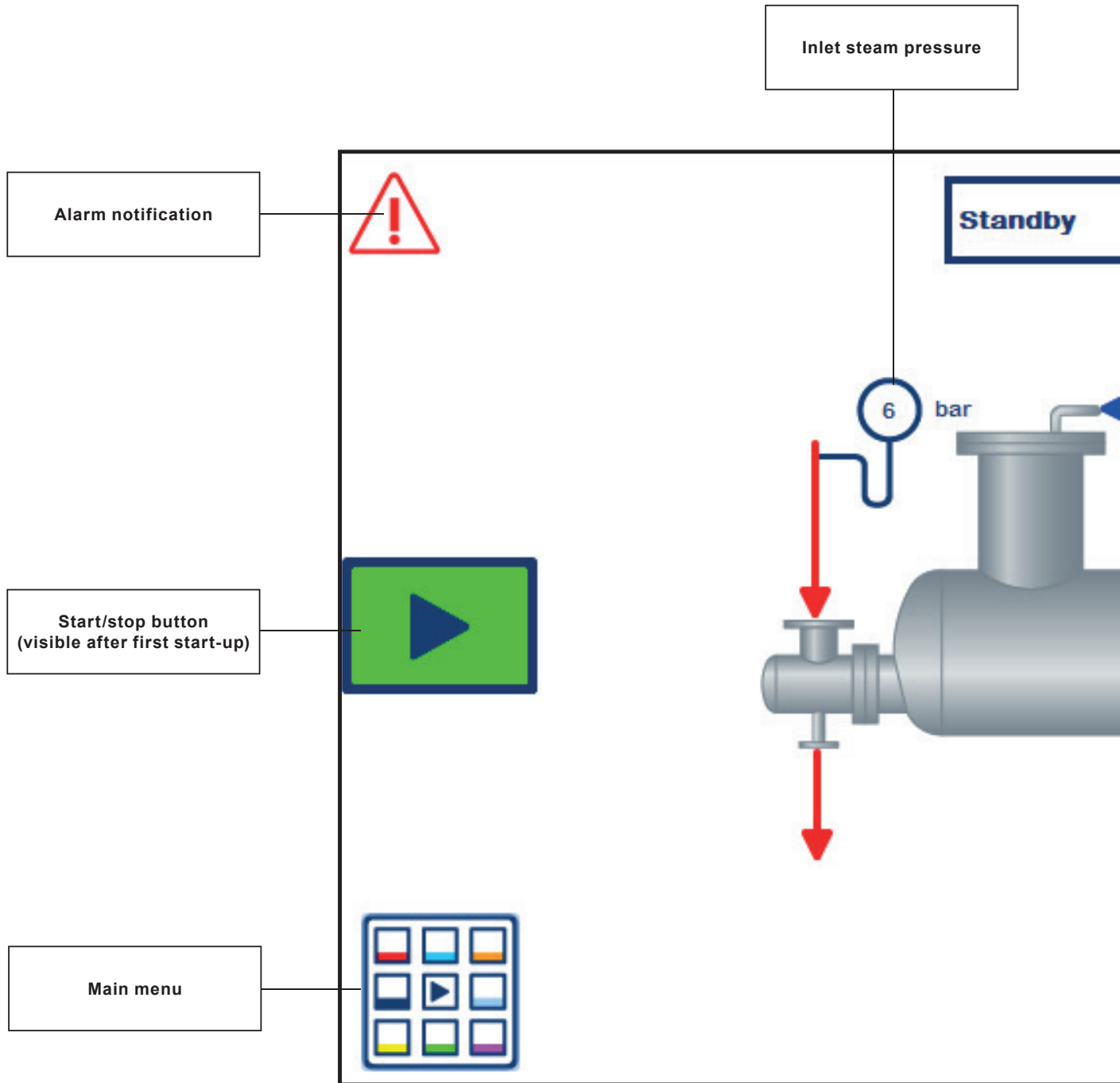
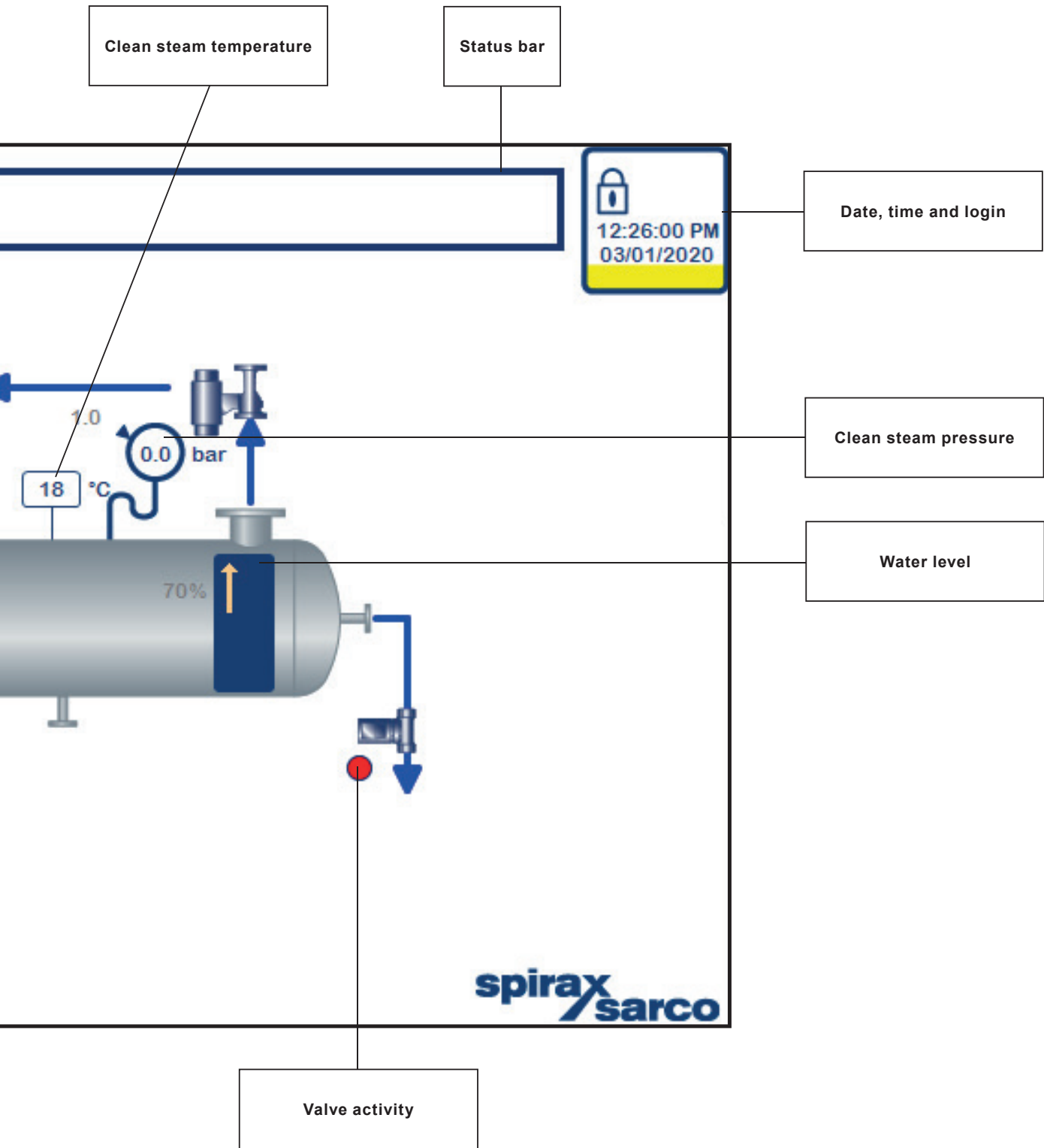
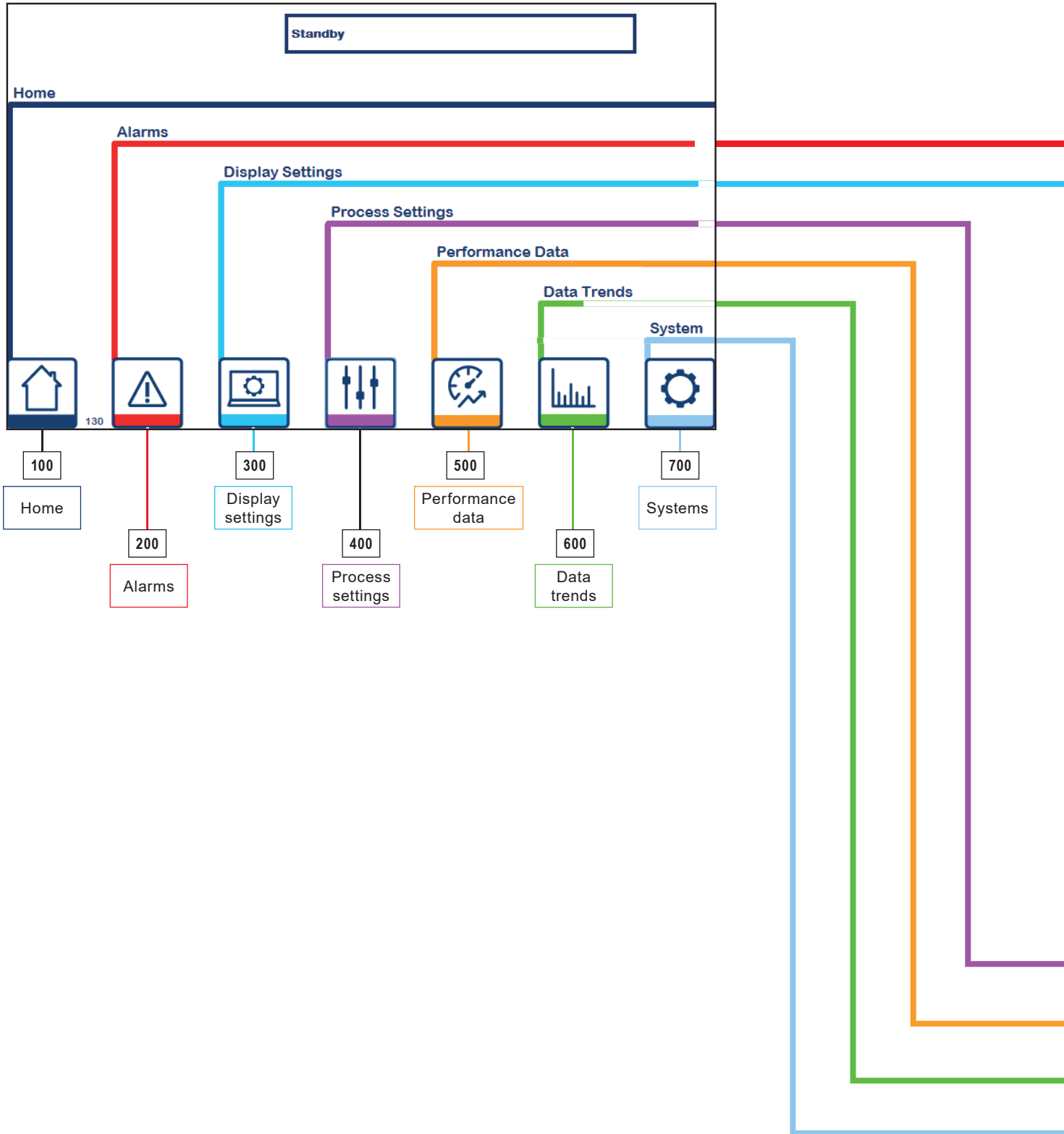

Fig. 10



10.3 Main menu

By selecting the Main Menu button from the Home screen, the user has access to settings, alarms and diagnostics screens. These are split in to 6 sub-menus as described below.





Active Alarms Standby

No.	Time	Text
13	02:52:59 PM	Water level analogue input alarm circuit open
9	02:52:59 PM	Feedwater flow rate analogue input alarm circuit open
5	02:52:59 PM	Water conductivity analogue input alarm circuit open
20	02:52:59 PM	Supply steam in pressure analogue input alarm circuit...
18	02:52:59 PM	Clean steam pressure analogue input alarm circuit o...
47	02:52:59 PM	Condensate out temperature analogue input alarm ci...
45	02:52:59 PM	Condensate temperature analogue input alarm circui...
43	02:52:59 PM	Supply steam temperature analogue input alarm circ...
41	02:52:59 PM	Clean steam temperature analogue input alarm circu...
38	02:52:59 PM	Panel temperature limit alarm
36	02:52:59 PM	Panel temperature analogue input alarm circuit open
34	02:52:59 PM	Feedwater temperature analogue input alarm circuit...
58	02:52:59 PM	Supply steam control valve feedback analogue input...

200

12:42:32 AM
03/01/1970



Display Standby

40 60 80 100

°C °F L/min G/min

Barg PSig kW BTU/hr

01/01/1970

12:00:00 AM

300

12:47:16 AM
03/01/1970

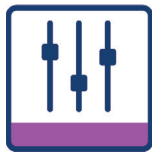

2

400 Main 2 Tune 0 11.85 bar 237.03°C

Process settings Standby 10:32:18 AM 03/01/2020

23 : 59

1.0 bar 5 mins

70 % 5 mins

Home Alarm Settings Process Settings Performance Trends Help



500 Main 2 Tune 0 11.85 bar 237.03°C

Performance Standby 10:35:36 AM 03/01/2020

Performance delta 0.00

Sample stop 0 HRS

Last test #### mins

Home Alarm Settings Process Settings Performance Trends Help

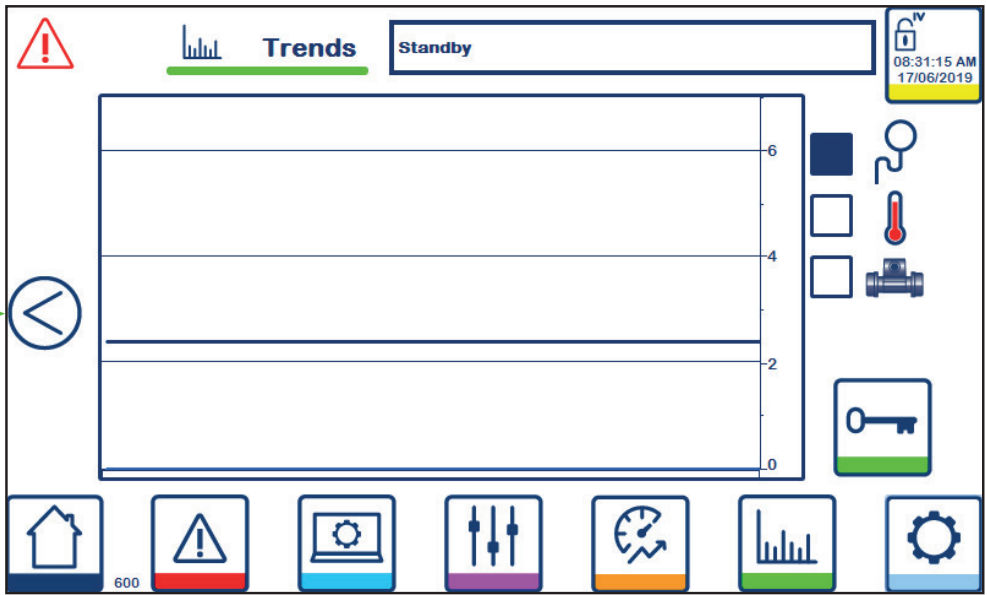

2

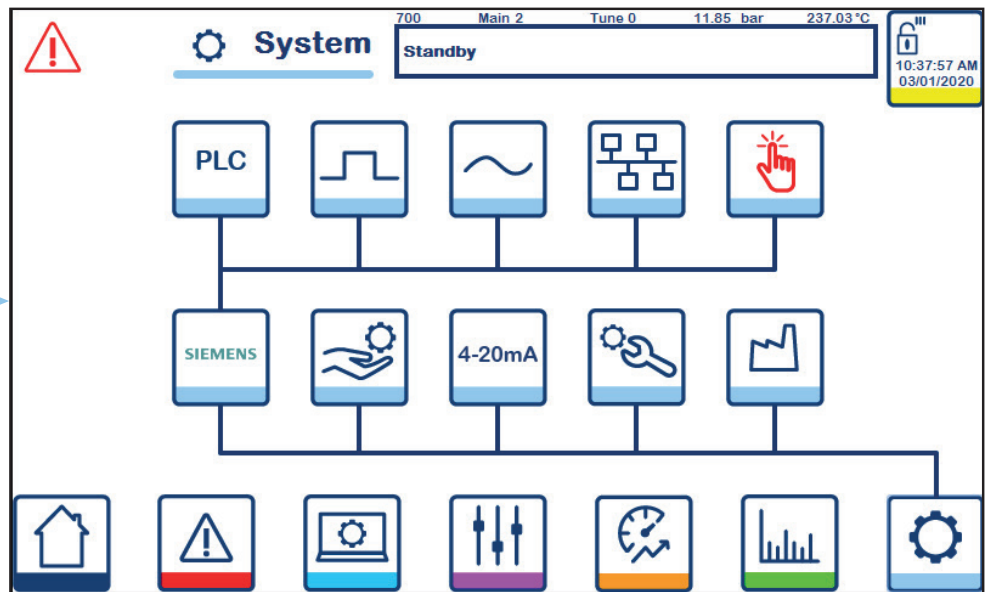

10.4 Alarms

The alarm screens display active and historic alarms as well as all the settings for the diagnostics alarms.



Active Alarms Standby

No.	Time	Text
13	02:52:59 PM	Water level analogue input alarm circuit open
9	02:52:59 PM	Feedwater flow rate analogue input alarm circuit open
5	02:52:59 PM	Water conductivity analogue input alarm circuit open
20	02:52:59 PM	Supply steam in pressure analogue input alarm circu...
18	02:52:59 PM	Clean steam pressure analogue input alarm circuit o...
47	02:52:59 PM	Condensate out temperature analogue input alarm ci...
45	02:52:59 PM	Condensate temperature analogue input alarm circui...
43	02:52:59 PM	Supply steam temperature analogue input alarm circ...
41	02:52:59 PM	Clean steam temperature analogue input alarm circ...
38	02:52:59 PM	Panel temperature limit alarm
36	02:52:59 PM	Panel temperature analogue input alarm circuit open
34	02:52:59 PM	Feedwater temperature analogue input alarm circuit...
58	02:52:59 PM	Supply steam control valve feedback analogue input...

200

Active alarms (200) remains on screen until they are acknowledged by the user.

Alarm History Standby

No.	Time	Text
! 13	02:52:59 PM	Water level analogue input alarm circuit open
! 9	02:52:59 PM	Feedwater flow rate analogue input alarm circuit...
! 5	02:52:59 PM	Water conductivity analogue input alarm circuit o...
! 20	02:52:59 PM	Supply steam in pressure analogue input alarm c...
! 18	02:52:59 PM	Clean steam pressure analogue input alarm circ...
! 47	02:52:59 PM	Condensate out temperature analogue input alar...
! 45	02:52:59 PM	Condensate temperature analogue input alarm ci...
! 43	02:52:59 PM	Supply steam temperature analogue input alarm...
! 41	02:52:59 PM	Clean steam temperature analogue input alarm c...
! 38	02:52:59 PM	Panel temperature limit alarm
! 36	02:52:59 PM	Panel temperature analogue input alarm circuit o...
! 34	02:52:59 PM	Feedwater temperature analogue input alarm cir...
! 58	02:52:59 PM	Supply steam control valve feedback analogue in...

210

Alarms history (210) provides an historic log of previous alarms including time and date stamp for clarification and diagnosis. A rolling total of 1024 alarms are retained until a power cycle of the CSG-HS.

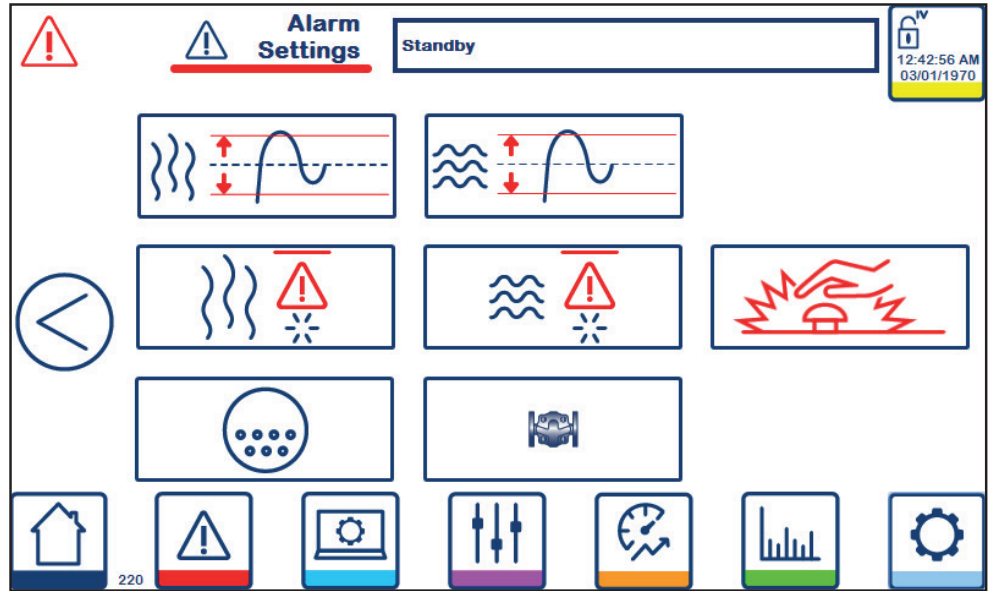

Alarm settings (220)

10.5 Display settings

The display settings screen, as well as altering the display units for the HMI, the user can also alter the time, date and language.

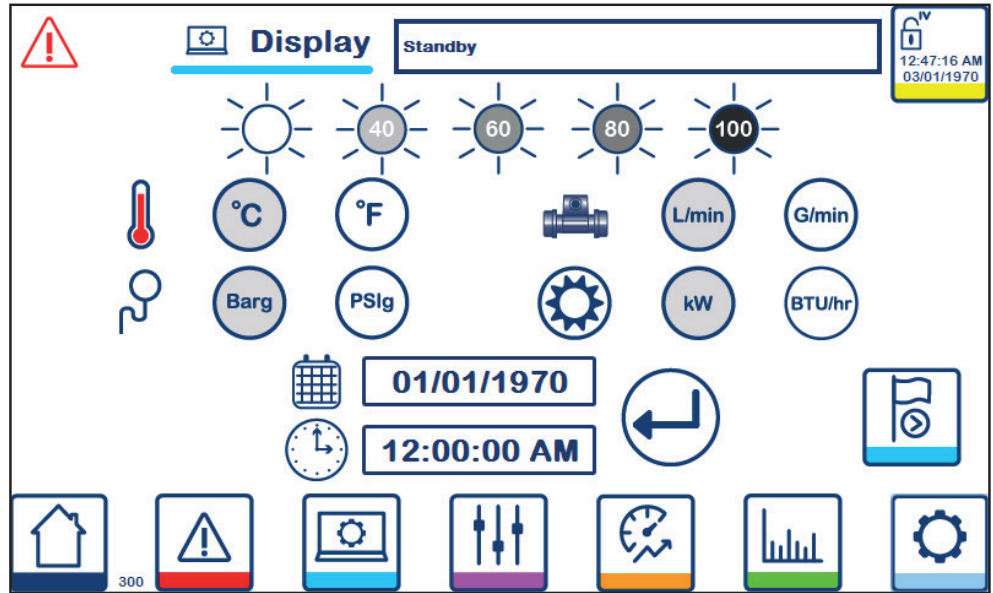

Display settings (300)

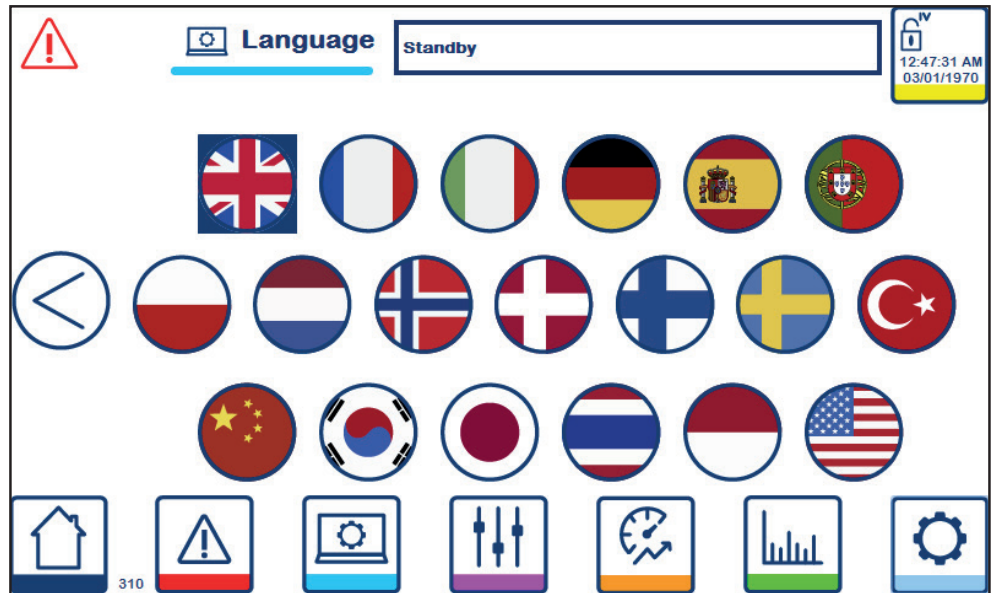

Language (310)

10.6 Process settings

The settings available across the process settings screens directly affect the running of the CSG-HS and the effective output of clean steam.

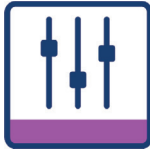

2

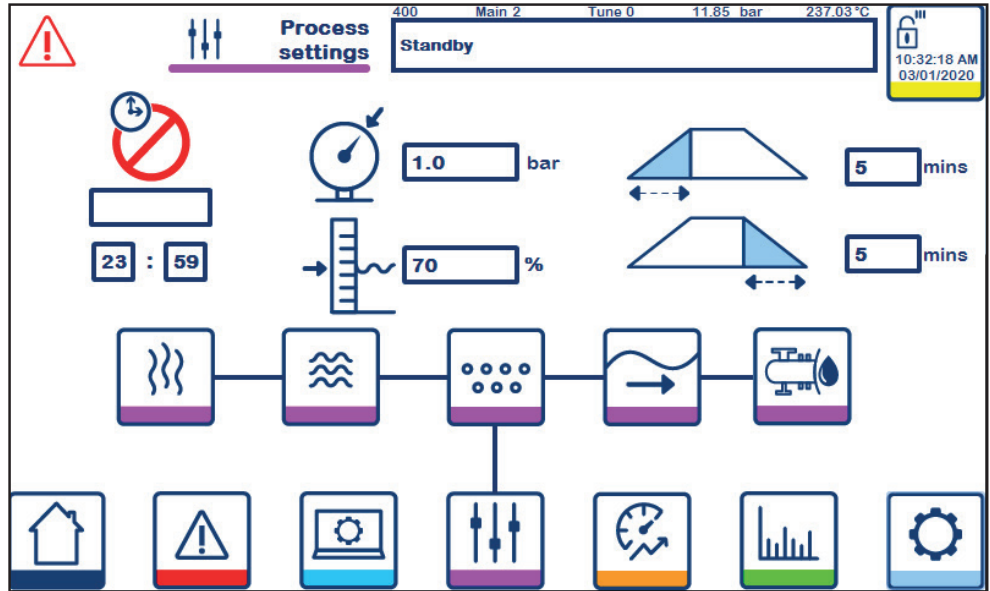

Main process set-points (400). Including clean steam pressure, water level, ramp up time and ramp down time.



2

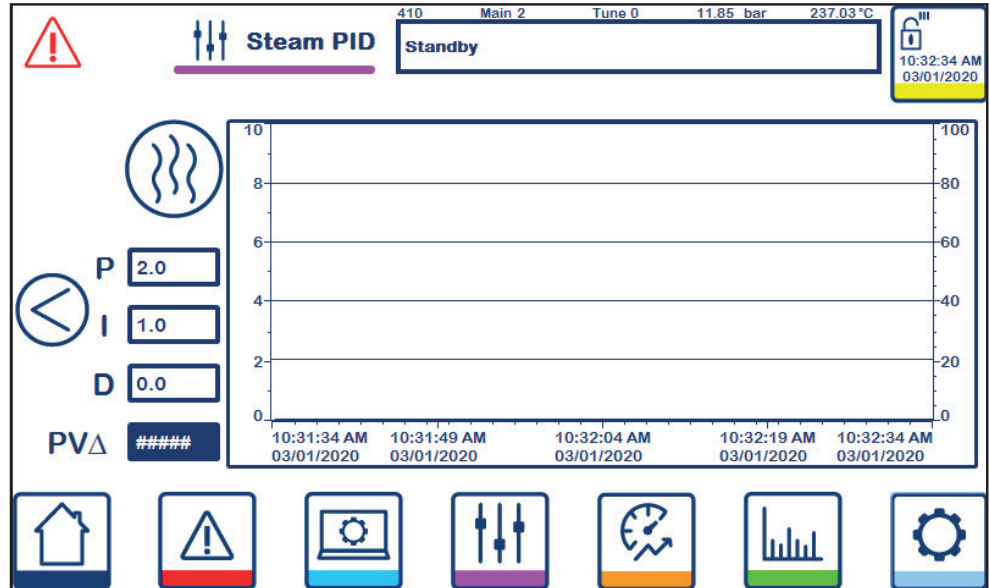

Steam PID settings (410) also includes a live PID graph showing the process and control values, and the process set-point.



2

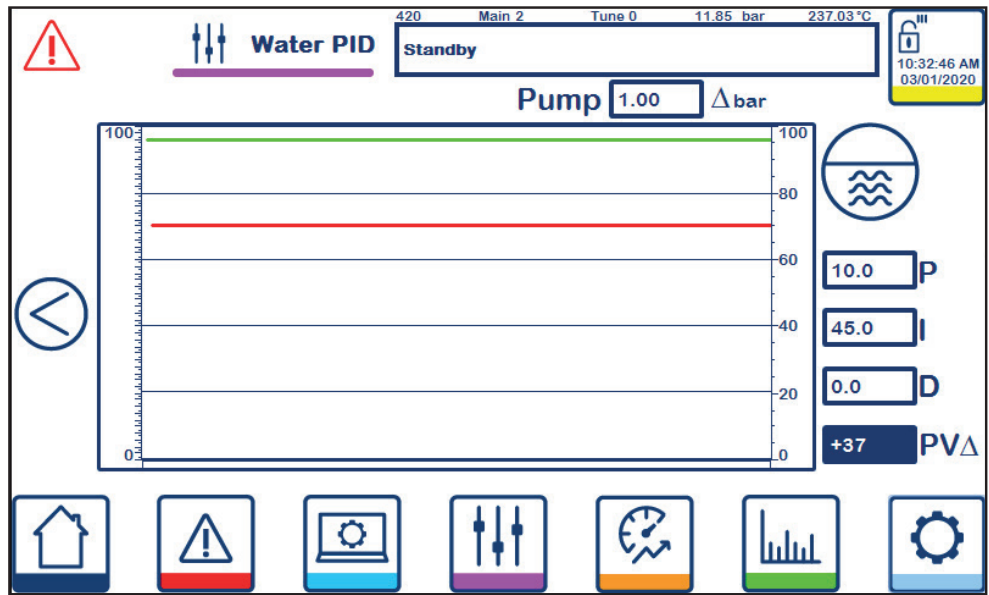

Water PID settings (420) also includes the pump offset value and a live PID graph showing the process and control values, and the process set-point.

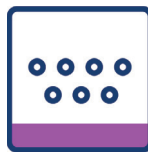

2

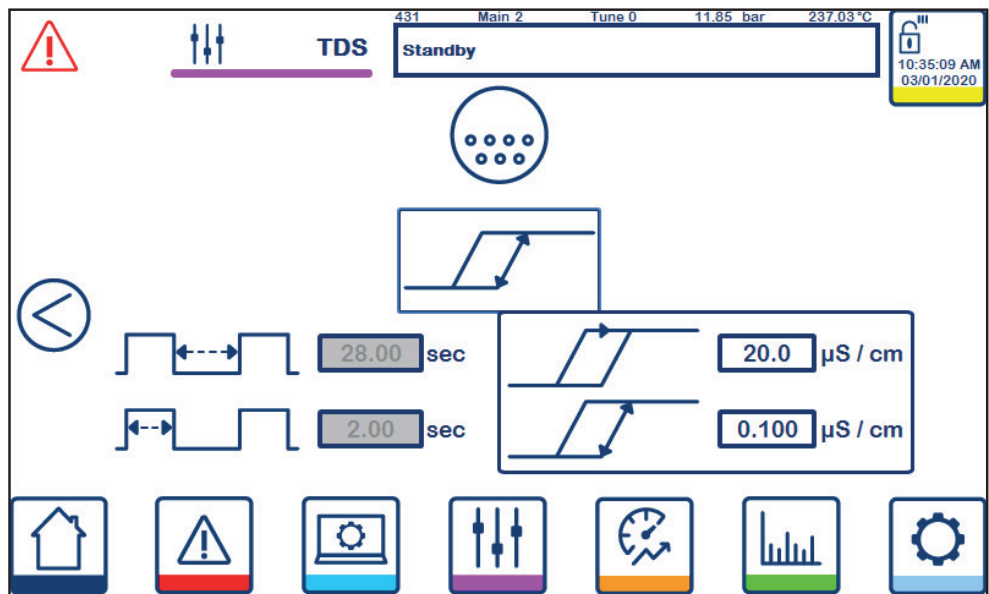

TDS settings (430-432) allows the user to set and select the TDS control they require.



2

440 Main 2 Tune 0 11.85 bar 237.03°C

Standby

10:33:31 AM
03/01/2020

High Demand drop %

Low Demand rate

Level SP rise %

Pressure SP drop %

Demand duration sec

Demand enable time sec

Forward controls (440)



2

450 Main 2 Tune 0 11.85 bar 237.03°C

Standby

10:33:46 AM
03/01/2020

Enable

Integrity test duration sec

Pressure drop limit %

Pressure rise limit %

Integrity test (450)

10.7 Performance data

The performance data screen will only display the performance profile of the CSG-HS whist in Running mode and once sufficient data has been collected. If the Performance Monitoring options pack has not been installed, no information will be available.

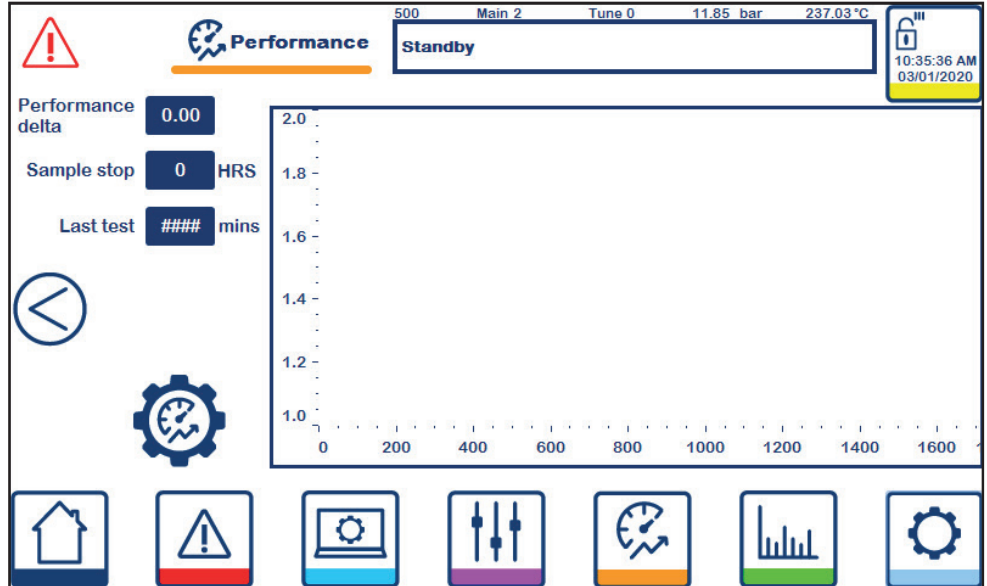

Performance data (500), as well as showing the current performance profile of the CSG-HS also shows the current data sample and data times.

2

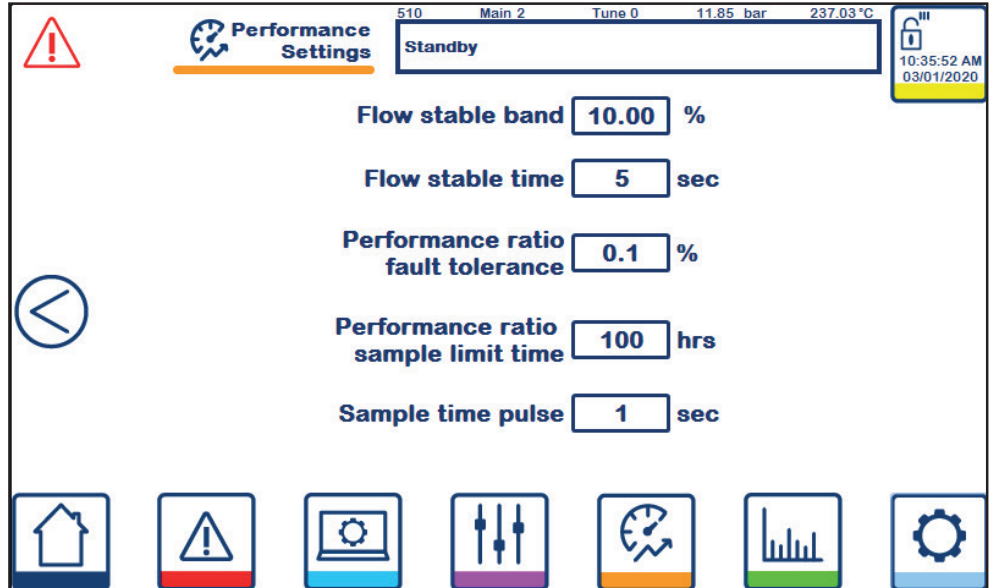

Performance data settings (510) allows users to alter the sampling process and performance tolerance.

10.8 Data trends

The live data displayed on the Trends screen is grouped in to similar process values.



Pressure variables.
All currently installed
pressure sensors.

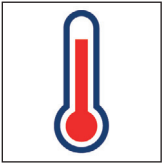

Temperature variables.
All currently installed
temperature sensors.



Flow variable from FA01 if
installed.

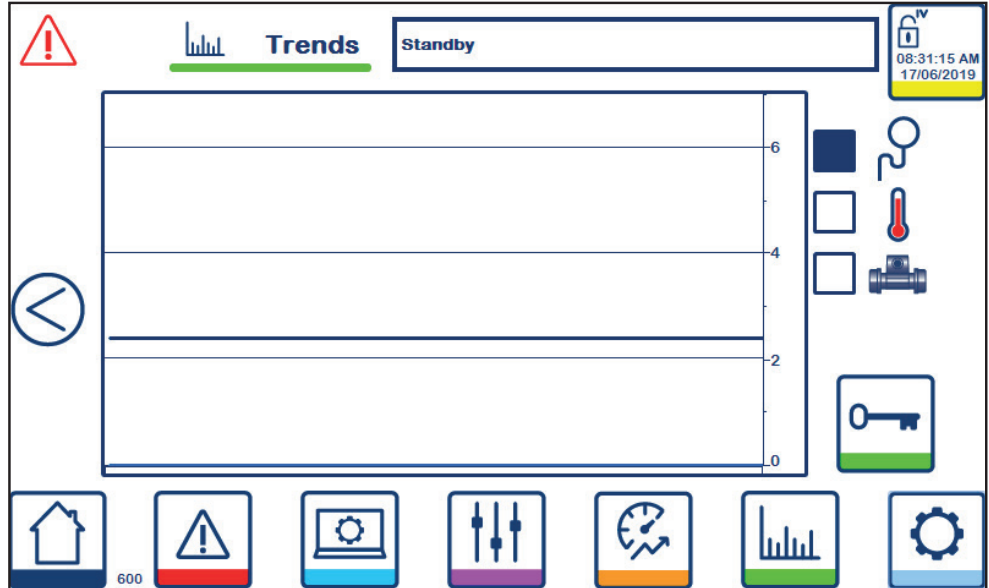

Trends (600) provided a live feed of the selected process variables.

10.9 System

System related controls and settings are available for the advanced user to alter the CSG-HS away from a pre-configured settings.



2

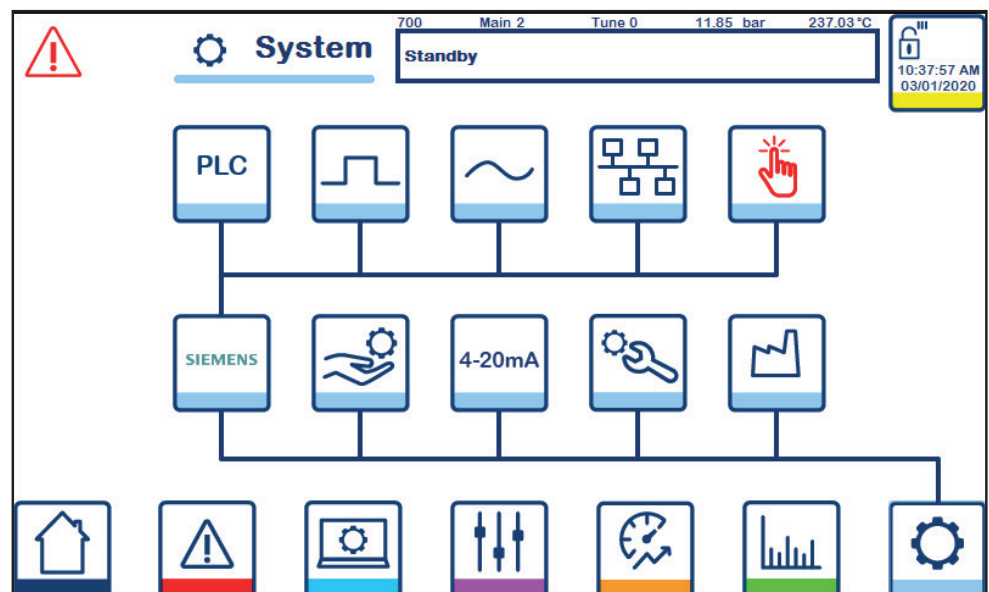

System sub menu (700)



2

PLC status (710) displays any PLC error codes and the stored PLC date and time.



2

Digital Input status (720) and digital output status (721)



2

Value	Unit	Description
4.5	mA	Feedwater temperature
4.6	mA	Water in temperature
5.1	mA	Clean Steam temperature
4.6	mA	Supply steam temperature
4.7	mA	Waste steam temperature
4.6	mA	Condensate temperature
4.0	mA	Clean Steam Pressure
4.0	mA	Supply steam in pressure
4.0	mA	Feedwater flow rate
5.1	mA	Water conductivity
10.9	mA	Water level
4.0	mA	Feedwater control valve
4.0	mA	Primary steam control valve

35.5 °C 9.7 mA Panel temperature

Analogue input status (730) and analogue output status (731)

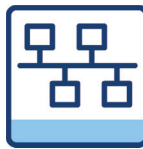

2

Modbus 01

Modbus 02

Modbus 03

Network status (740)

2

741 Main 2 Tune 0 11.85 bar 237.03°C

Network Standby

Address	Description	Value
1	PA01 feedwater pressure	1185
2	PA21 clean steam pressure	1185
3	TA01 feedwater temp	23703
4	TA21 clean steam temp	23703
5	FA01 feedwater flow rate	17094
6	CA11 conductivity	11851
7	LA21 Water level	9567
8	VB01 Feedwater control value	0
9	VA01 Feedwater control valve feedback	11851
10	VB31 Supply steam control value	0

Modbus 01
Modbus 02
Modbus 03

Communications tables and status (741-745)

2

742 Main 2 Tune 0 11.85 bar 237.03°C

Network Standby

Address	Description	Value
11	VA31 Supply steam control valve feedback	11851
12	Clean steam pressure PID SP	0
13	Water level PID SP	7000
14	TDS SP	2000
15	Clean steam superheat	2401
16	NCG %	50864
17	Run timer	0
18	Diagnostic WORD	640
19	Alarms 1 WORD	20880
20	Alarms 2 WORD	10

Modbus 01
Modbus 02
Modbus 03

2

Address	Description	Value
21	Alarms 3 WORD	17706
22	Alarms 4 WORD	6785
23	Alarms 5 WORD	4393
24	Alarms 6 WORD	130
25	Run status	2
26	Watchdog out	41
27	Watchdog return	99
28	Command WORD	0
29	Remote Clean Steam Pressure Set-point	0
30	Spare	0

2

- VE12 TDS valve
- VE21 Outlet Isolation valve
- VE31 Inlet Isolation valve
- VE32 Test, level isolation valve
- VE33 Test, compressed air/vent valve
- VE51 Test, condensate isolation valve

Digital override (750) open and close fitted and available isolation valves (only available in standby mode)



2

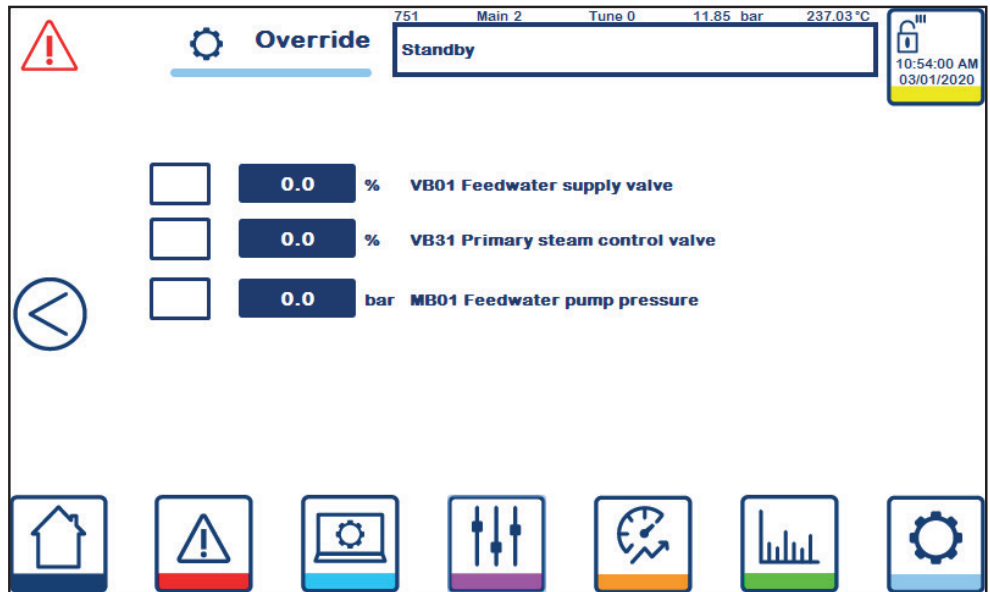

Analogue override (751) enable and move control valves to specific position. (only available in standby mode)



2



Service (760) allows users to begin service sequence, enter PID Tuning mode (only available in standby mode) or Running Tuning mode (only available when in Run mode).

4-20mA

2

Variable	4 mA	20 mA
FA01 Feedwater Flow rate	48.8	1450.0
PA21 Clean Steam pressure	0.0	10.0
PA31 Supply steam pressure	0.0	10.0
CA11 Water conductivity	0.00	100.00
LA11 Water level	16.7	83.3
FA01 Feedwater flow smoothing	2 x 0.2sec	10 x samples
LA11 Water level smoothing	1 x 0.2sec	2 x samples

Scaling (770) allows alteration of the 4-20 mA input scaling and the input smoothing of FA01 and LA11 (only available in standby mode).

3



2

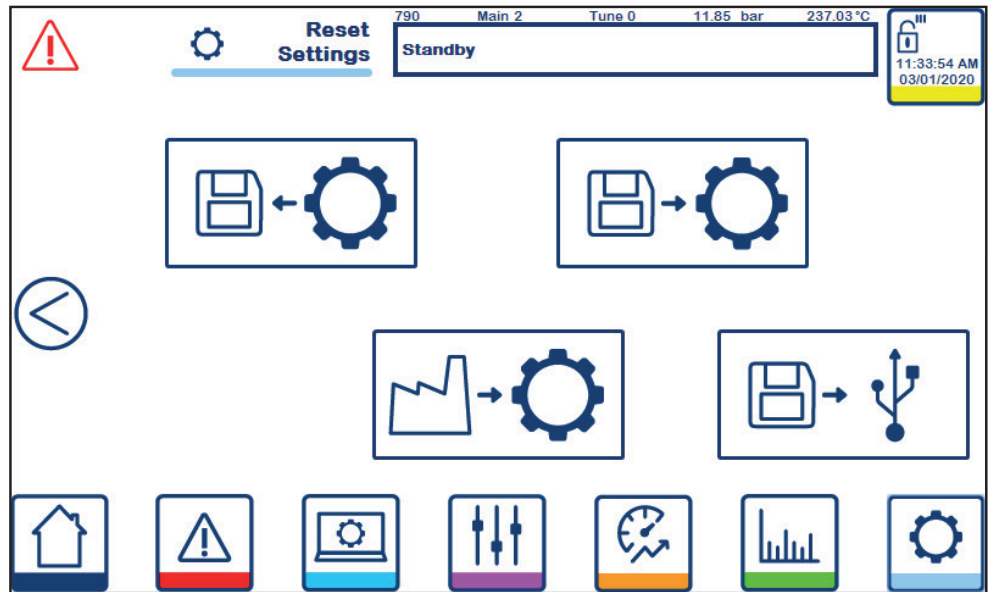

Factory reset (790) allows users to save, load and reset the current settings and configuration of the CSG-HS. (only available in standby mode)

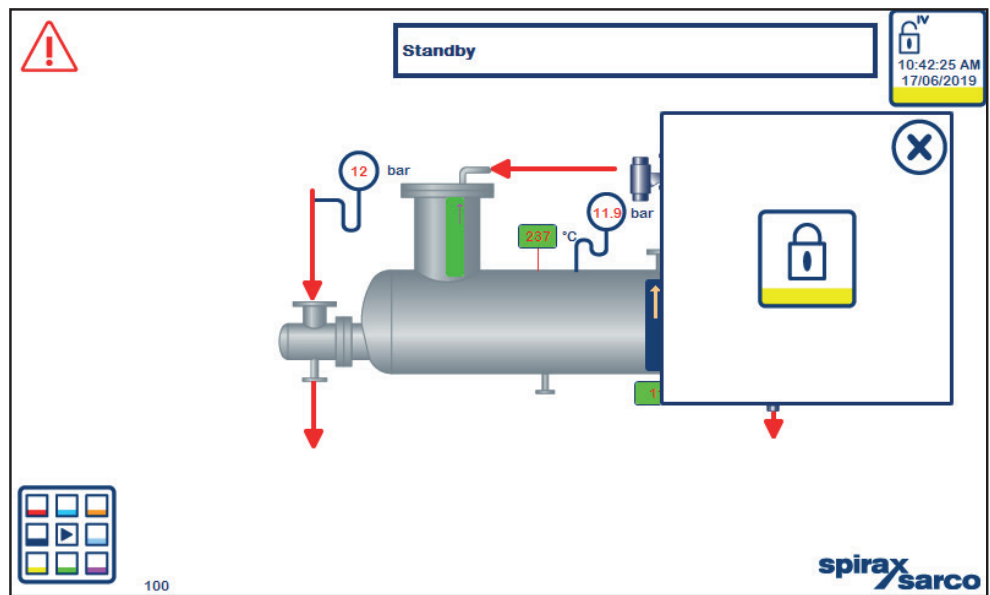

Security screen (800), allows users to logoff from the current user.

11. Appendix

The torquing procedure should follow the steps detailed in this Appendix:

- Lubricate the bolt threads and the nut faces with a suitable lubricant.
- Insert the bolts through the flanges and finger tighten the nuts.
- Number all bolts so that torquing requirements can be followed.
- Apply torque in 20%, 1/5 steps of required final torque, loading all bolts at each step before proceeding to the next step.
- Use rotational tightening until all bolts are stable at final torque level.

The torque tightening values for the clean steam generator header and deareator flanges are detailed in the following table:

	Header flange bolts			Deareator flange bolts		
	Quantity	Ø	Torque* (N m)	Quantity	Ø	Torque* (N m)
GVS400	4	M14	25	12	M20	50
GVS500	8	M16	40	12	M24	80
GVS601	12	M16	45	16	M27	125
GVS602	12	M16	45	16	M27	125

* Gaskets as per original spare parts

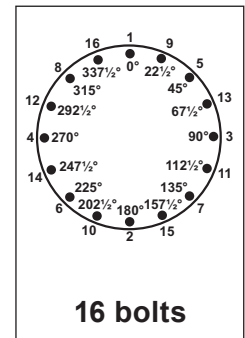
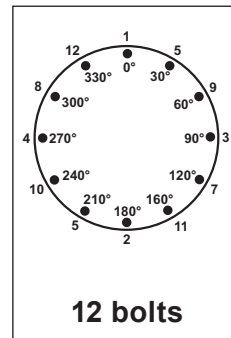
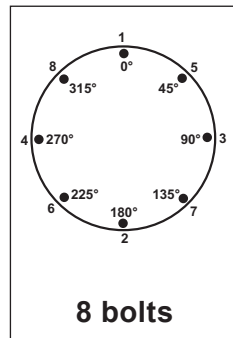
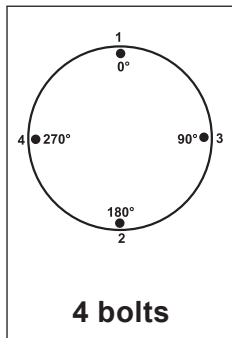

Sequential Order	Rotational Order
1 - 2	1
3 - 4	3

2	4
---	---

Sequential Order	Rotational Order
1 - 2	1
3 - 4	5
5 - 6	3
7 - 8	7

































2	6	4	8
---	---	---	---

















Sequential Order	Rotational Order
1 - 2	1
3 - 4	5
5 - 6	9
7 - 8	3
9 - 10	7
11 - 12	11



2	6	10	4	8	12
---	---	----	---	---	----

Sequential Order	Rotational Order
1 - 2	1
3 - 4	9
5 - 6	5
7 - 8	13
9 - 10	3
11 - 12	11
13 - 14	7
15 - 16	15

2	10	6	14	4	12	8	16
---	----	---	----	---	----	---	----

	Setting	Units	Lower limit	Upper limit	Default	Setting
	Alarm settings					
	Clean steam pressure band alarm					
	High band	%	1.0	10.0	10.0	
	Low band	%	1.0	10.0	10.0	
	Alert time	sec	1	30	10	
	Alarm time	sec	30	180	30	
	Water level band alarm					
	High band	%	1.0	10.0	10.0	
	Low band	%	1.0	10.0	10.0	
	Alert time	sec	1	30	10	
	Alarm time	sec	30	180	30	
	Clean steam control capacity alarm					
	Alert time	sec	1	60	30	
	Alarm time	sec	1	60	60	
	Water level control capacity alarm					
	Alert time	sec	1	60	30	
	Alarm time	sec	1	60	60	
	TDS alarm					
	TDS high time	sec	0	600	600	
	Hysteresis time	sec	0	600	600	
	Water level band alarm					
	Trap fail open temperature difference	°C			15.0	
	Trap fail closed temperature	°C			15.0	
	Maximum water level valve opening	sec	0.0	20.0	5.0	
	Maximum clean steam valve opening	sec	0.0	20.0	10.0	
	Process settings					
	Main process					
	Clean steam pressure	bar	1.0	6.0	1.0	
	Water level	%	60	80	70	
	Ramp up time	min	2	10	5	
	Ramp down time	min	2	10	5	
	Timed shut-down	time	00:00	23:59	disabled	
	Clean Steam PID					
	Proportional gain	-	1.0		2.0	
	Integral gain	-	0.0		1.0	
	Derivative gain	-	0.0		0.0	

	Setting	Units	Lower limit	Upper limit	Default	Setting
	Water level PID					
	Proportional gain	-	1.0		10.0	
	Integral gain	-	0.0		45.0	
	Derivative gain	-	0.0		0.0	
	Pump pressure	Δbar	0.5	2.0	1.0	
	TDS (Interval only)					
	Interval time	sec	5.00		28.00	
	Duration time	sec	0.00		2.00	
	TDS (CP10)					
	Interval time	sec	5.00		28.00	
	Duration time	sec	0.00		2.00	
	TDS setpoint	μS	10.0		35.0	
	Hysteresis band	μS	0.001	20.000	0.100	
	TDS (CP32)					
	Interval time	sec	5.00		28.00	
	Duration time	sec	0.00		2.00	
	TDS setpoint	μS	10.0		35.0	
	Hysteresis band	μS	0.001	20.000	0.100	
	Forward Controls					
	High Demand drop	%	5.00	20.00	10.00	
	Level SP rise	%			10	
	Low Demand rate		0.00	1.00	0.10	
	Pressure SP drop	%			10	
	Demand duration	sec	1	10	5	
	Demand enable time	sec	1	60	10	
	Integrity test					
	Integrity test duration	sec			60	
	Pressure drop limit	%	-100	-1	-2	
	Pressure rise limit	%	100	1	2	
	Forward Controls					
	Flow stable band	%			10.00	
	Flow stable time	sec			5	
	Performance ratio fault tolerance	%			0.1	
	Performance ratio sample limit time	hrs			100	
	Sample time pulse	sec			1	

	Setting	Units	Lower limit	Upper limit	Default	Setting
	4-20mA					
	FA01 4mA	L/min			48.80	
	FA01 20mA	L/min			1450.0	
	PA01 4mA	bar			0.00	
	PA01 20mA	bar			10.0	
	PA21 4mA	bar			0.00	
	PA21 20mA	bar			10.0	
	PA31 4mA	bar			0.00	
	PA31 20mA	bar			10.0	
	CA11 4mA	µS			0.0	
	CA11 20mA	µS			100.0	
	LA11 4mA (Viscorol)	%			0.0	
	LA11 20mA (Viscorol)	%			100.0	
	LA11 4mA (LP20)	%			16.7	
	LA11 20mA (LP20)	%			83.3	
	FA01 Feedwater flow smoothing				Enable	
	FA01 smothing interval	0.2sec			2	
	FA01 smothing samples				10	
	LA11 Water level smoothing				Disable	
	LA11 smothing interval	0.2sec			1	
	LA11 smothing samples				2	
	Configuration					
	Water setpoint delta select				Enable	
	Warmup pressure check				Enable	
	VB31 warm	%			10.0	
	Pressure SP minimum	bar	0.0	10.0	1.0	
	Pressure SP maximum	bar	0.0	10.0	6.0	
	Atmospheric Pressure	barA			1.013	

Service

For technical assistance contact our nearest Office or Agency or contact directly:

SPIRAX SARCO S.r.l. – Service
Via per Cinisello, 18 - 20834 Nova Milanese (MB) - Italy
Tel.: (+39) 0362 4917 257 - (+39) 0362 4917 211
Fax: (+39) 0362 4917 315
E-mail: support@it.spiraxsarco.com

Warranty

Ascertained partial or complete non-compliance with these regulations will result in forfeiture of the related warranty.

