



Fig 37 SG Iron Strainer

Description

The Fig 37 is an SG iron integrally flanged Y-type strainer.

The standard stainless steel screen in the DN15 to DN80 size range is 0.8 mm perforations, in the DN100 to DN200 it is 1.6 mm perforations.

As options other perforations and mesh sizes are available as well as monel screens. The strainer cap can be drilled and tapped for blowdown and drain valves if required.

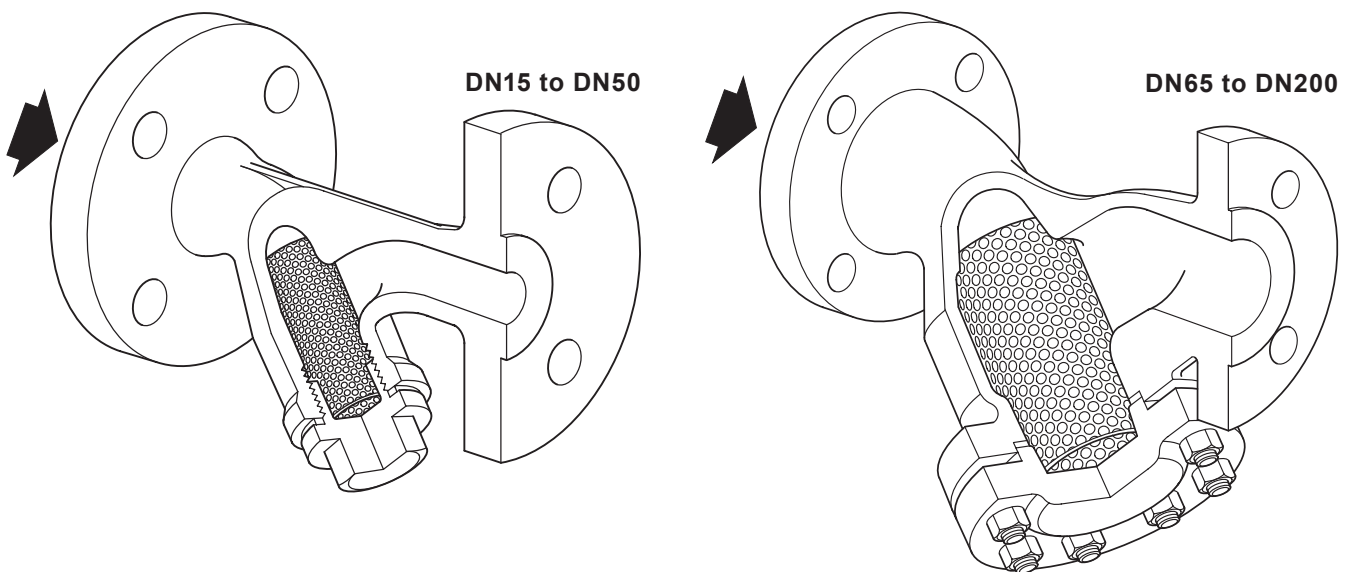

Optional extras

Strainer screens

Stainless steel screen	Perforations	1.6 mm (DN15 to DN80)
		3.0 mm (DN15 to DN200)
	Mesh	40, 100 and 200
Monel screen	Perforations	0.8 mm (DN15 to DN80)
		3.0 mm (DN15 to DN200)
	Mesh	100

Blowdown or drain valve connections

The cap can be drilled to the following sizes to enable a blowdown or drain valve to be fitted at extra cost.

Strainer size	Blowdown valve	Drain valve
DN15	¼"	¼"
DN20 and DN25	½"	½"
DN32, DN40 and DN50	1"	¾"
DN65 to DN125	1¼"	¾"
DN150 and DN200	2"	¾"

Standards

This product fully complies with the requirements of the EU Pressure Equipment Directive/UK Pressure Equipment (Safety) Regulations.

Certification

The product is available a manufacturers' Typical Test Report for the body and cap as standard and EN 10204 3.1 to special order at extra cost.

Note: All certification/inspection requirements must be stated at the time of order placement.

Sizes and pipe connections

DN15 to DN150 standard flange EN 1092 PN40 and ANSI 150.

DN200 standard flange EN 1092 PN25 and ANSI 150.

JIS/KS 10K and 20K.

Materials

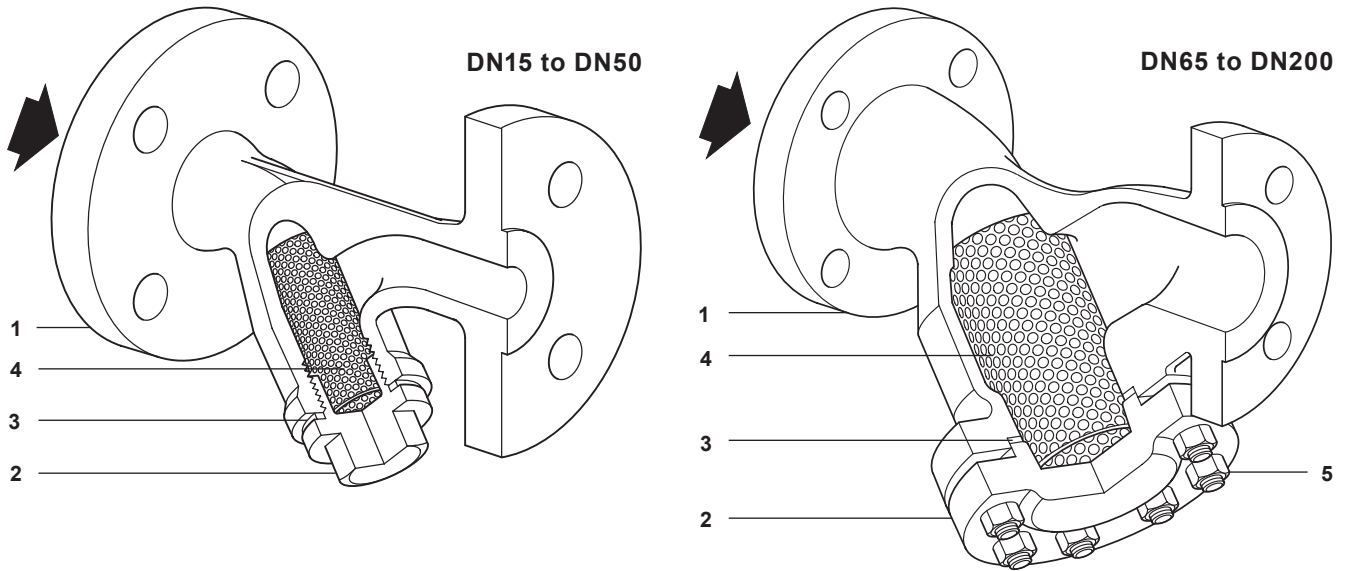

No.	Part	Materials
1	Body	SG iron DIN 1693 GGG 40
		DN15 to DN50 Carbon steel DIN 17245 C22.8
2	Cap	DN65 to DN100 SG iron EN-GJS-400-15
		DN125 to DN200 Carbon steel DIN 17245 GS C25N
3	Cap gasket	Reinforced exfoliated graphite
4	Strainer screen	Stainless steel ASTM A240 316L
5	Cap stud	DN65 to DN200 Carbon steel BS 4439 Gr. 8.8
		Cap nut DN65 to DN200 Carbon steel BS 3692 Gr.

Pressure/temperature limits

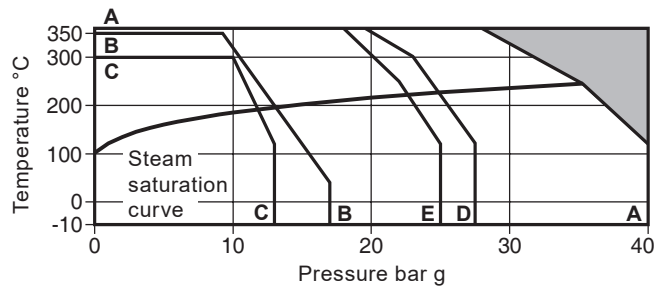

The product **must not** be used in this region.

- A - A** Flanged EN 1092 PN40.
- B - B** Flanged ANSI 150.
- C - C** Flanged JIS/KS 10K.
- A - D** Flanged JIS/KS 20K.
- A - E** Flanged EN 1092 PN25.

Body design conditions	DN15 - DN150	PN40
	DN200	PN25
PMA Maximum allowable pressure	DN15 - DN150	40 bar g @ 120 °C
	DN200	25 bar g @ 120 °C
TMA Maximum allowable temperature		350 °C
Minimum allowable temperature		-10 °C
PMO Maximum operating pressure	DN15 - DN150	40 bar g @ 120 °C
	DN200	25 bar g @ 120 °C
TMO Maximum operating temperature	DN15 - DN150	350 °C @ 28.5 bar g
	DN200	350 °C @ 17.5 bar g
Minimum operating temperature		-10 °C
	PN25	38 bar g
	PN40	60 bar g
Designed for a maximum cold hydraulic test pressure of:	ANSI 150	30 bar g
	JIS/KS 20K	49 bar g
	JIS/KS 10K	28 bar g

Kv values

Size	DN15	DN20	DN25	DN32	DN40	DN50	DN65	DN80	DN100	DN125	DN150	DN200
Perforations 0.8, 1.6 and 3 mm	5	8	13	22	29	46	72	103	155	237	340	588
Mesh 40 and 100	5	8	13	22	29	46	72	103	155	237	340	588
Mesh 200	4	6	10	17	23	37	58	83	124	186	268	464

For conversion:

$$C_v \text{ (UK)} = K_v \times 0.963$$

$$C_v \text{ (US)} = K_v \times 1.156$$

Dimensions/weights (approximate) in mm and kg

Size	PN40 A	PN25 A	ANSI 150 A	JIS 10K A	JIS 20K	B	C	Screening area cm ²	Weight
DN15	130	-	122	123	127	70	110	25	1.85
DN20	150	-	142	143	147	80	130	42	2.80
DN25	160	-	156	153	156	95	150	71	3.50
DN32	180	-	176	177	180	135	225	135	6.20
DN40	200	-	200	197	200	145	240	161	7.40
DN50	230	-	230	223	227	175	300	251	11.20
DN65	290	-	291	282	286	200	335	352	20.00
DN80	310	-	311	298	306	210	340	360	24.00
DN100	350	-	-	337	349	255	415	540	36.00
DN125	400	-	398	389	401	300	510	840	60.00
DN150	480	-	482	469	481	345	575	1 115	83.00
DN200	-	600	600	585	601	435	730	1 905	148.00

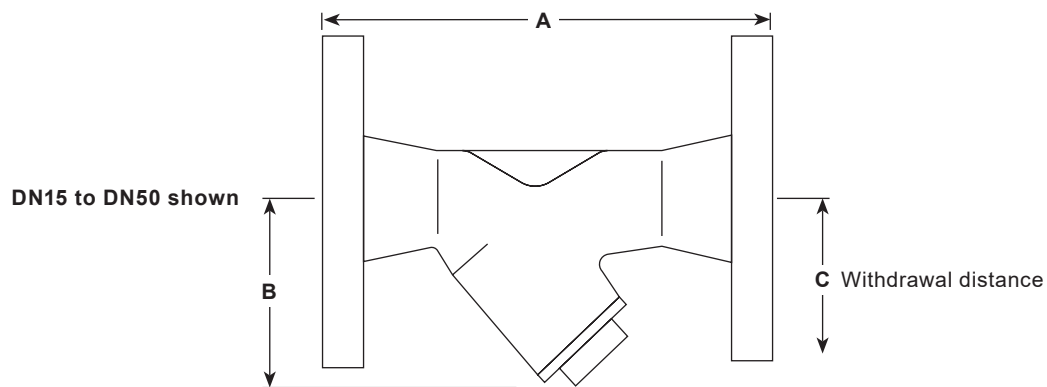

Safety information, installation and maintenance

For full details see the Installation and Maintenance Instructions (IM-S60-18) supplied with the product.

Warning

The strainer cap gasket contains a thin stainless steel support ring, which may cause physical injury if not handled and disposed of carefully.

Disposal

The product is recyclable. No ecological hazard is anticipated with disposal of this product, providing due care is taken.

How to order

Example: 1 off Spirax Sarco DN80 Fig 37 strainer having flanged EN 1092 PN40 connections with a stainless steel screen having 0.8 mm perforations.

Spare parts

The spare parts available are shown in solid outline. Parts drawn in a grey line are not supplied as spares.

Available spares

Strainer screen (state material, size of perforation or mesh and size of strainer)	4
Cap gasket (packet of 3)	3



How to order spares

Always order spares by using the description given in the column headed 'Available spares' and state the size and type of strainer and perforation or mesh required.

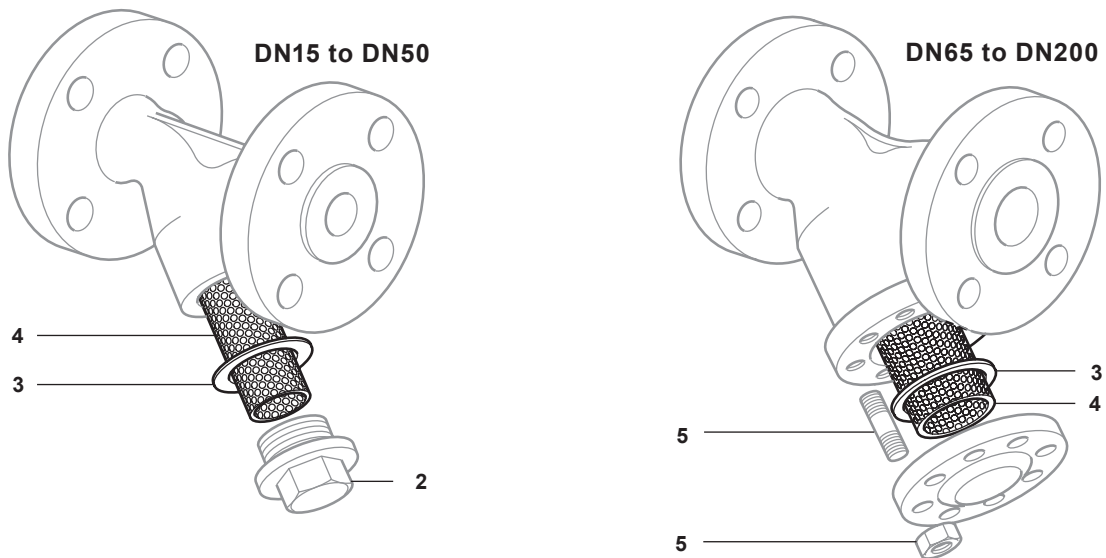
Example: 1 off Stainless steel strainer screen having 0.8 mm perforations for a DN50 Spirax Sarco Fig 37 strainer having EN 1092 PN25 connections.



Recommended tightening torques

Item	Qty	Size	or		N m
					
2	1	DN15	22	M28	50 - 55
	1	DN20	27	M32	60 - 66
	1	DN25	27	M42	100 - 110
	1	DN32	46	M56	250 - 275
	1	DN40	50	M60	250 - 275
	1	DN50	60	M72	310 - 340
5	8	DN65	19	M12 x 35	20 - 24
	8	DN80	19	M12 x 35	30 - 35
	8	DN100	24	M16 x 45	70 - 77
	8	DN125	30	M20 x 50	80 - 88
	8	DN150	30	M20 x 55	100 - 110
	12	DN200	36	M24 x 65	90 - 100