



## Colima MEC Series Magnetic Level Switches

### Description

Magnetic activated level switches for controlling liquid levels in most industrial applications. When they have been installed at the point of operation, they work as on/off switches and are used for full automatic management of tanks (including pressurised ones) allowing operations such as starting/stopping of pumps, opening/closing of solenoid valves and activation of alarm systems. One or more instruments can be used, depending on the number of operation points necessary. The level switches can be equipped with electrical contacts, reed or micro switches along with various forms of protective housings to suit most environmental and safety conditions.













**MEC type A**  
with round flange and weather-proof housing

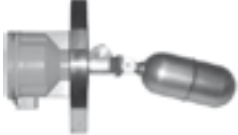



### Standards and certifications

This product fully complies with the requirements of the European Directive ATEX 94/9/EC, PED 97/23/EC. RINA and M.M.I approved.

### Available types

<p><b>MEC</b></p>  <p>Standard type for general purpose, used in most industrial applications. Horizontal mounting. One operation point. In the picture, the 100% stainless steel versions suitable for low temperatures, for installation in high saline concentration environments and for use in the food industry.</p> <p style="text-align: right;"><b>A</b></p>	<p><b>MEC</b></p>  <p>Type with differential range, adjustable <math>\pm 40^\circ</math> in two directions. Can be used as a start/stop with a single instrument. Horizontal mounting. The differential increases depending on the length of the stem and there are 7 regulation points, every <math>15^\circ</math>.</p> <p style="text-align: right;"><b>D</b></p>
<p><b>MEC</b></p>  <p>Type with cooling extension, to be used in applications with temperatures from <math>150^\circ\text{C}</math> to <math>350^\circ\text{C}</math>. It can also be assembled in types D, DV, L, S. Horizontal or vertical mounting. One operation point.</p> <p style="text-align: right;"><b>AT</b></p>	<p><b>MEC</b></p>  <p>Type with differential range, adjustable in one direction, only <math>0 - 40^\circ</math>. Can be used as a start/stop with a single instrument. Vertical mounting. The differential increases depending on the length of the stem and there are 4 regulation points, every <math>15^\circ</math>.</p> <p style="text-align: right;"><b>DV</b></p>
<p><b>MEC</b></p>  <p>Type suitable for controlling liquid with specific gravity <math>\geq 0.5 \text{ kg/l}</math>. Horizontal mounting. Float with counterweight. One operation point.</p> <p style="text-align: right;"><b>CP</b></p>	<p><b>MEC</b></p>  <p>Specific type for high vibration with reed switch contact. Frequencies <math>5\text{-}100 \text{ Hz}</math>. Horizontal mounting. One operation point.</p> <p style="text-align: right;"><b>AV</b></p>

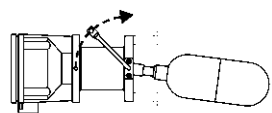
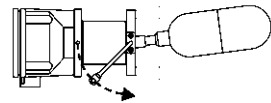
<p><b>MEC</b></p>  <p>Type equipped with protection bellow to avoid any deposits or inclusions present in the process liquid, eliminating risk of blockage. It can also be mounted on types D, DV, L and S. Horizontal mounting. One operation point. Stem length depending upon application.</p>	<p><b>M</b></p>
<p><b>MEC</b></p>  <p>Type indicated for sunken or difficult to access tanks (high or low level). Vertical mounting on pole in open tanks or in tanks with manhole. Attention must be paid to the connection rating: float is 120 mm. One operation point, with field adjustable start/stop function. Stem length depending upon application.</p>	<p><b>O</b></p>
<p><b>MEC</b></p>  <p>Pneumatic type, suitable in applications where electricity is not allowed. Stainless steel body with three ways valve. Horizontal or vertical mounting. One operation point.</p>	<p><b>PN</b></p>
<p><b>MEC</b></p>  <p>Type recommended in applications containing foam, inclusions and viscous fluids, where conditions require that the fulcrum point is not in touch with the process liquid. Vertical mounting. One operation point. Stem length depending upon application.</p>	<p><b>L</b></p>

<p><b>MEC</b></p>  <p>Type recommended in applications containing foam, inclusions and viscous fluids, where conditions require that the fulcrum point is not in touch with the process liquid. Horizontal mounting. One operation point. Stem length depending upon application.</p>	<p><b>S</b></p>
<p><b>MEC</b></p>  <p>Type equipped with a device for field verification (operation checking). Mostly used in the naval industry. Can also be made in types L and S. Horizontal and vertical mounting. One operation point.</p> <p>Example of manual operation checking, to be carried out in the field</p>  	<p><b>T</b></p>
<p><b>MEC MINI</b></p>  <p>Small dimension type. Horizontal or vertical mounting. One operation point. IP54 and IP67 protection degree.</p>	<p><b>MM</b></p>

**Operating principle**

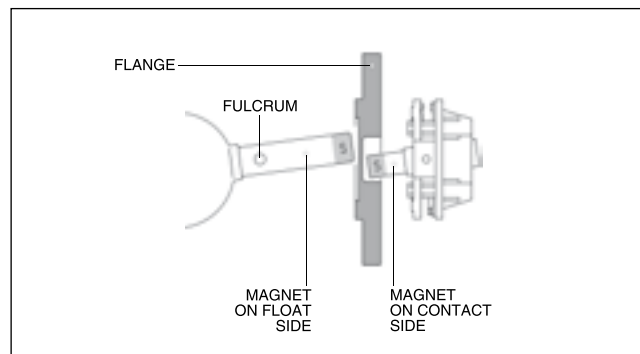

Two oscillating magnets on the same axis, one integral with the float and one integral with the electrical equipment, repel each other reciprocally through a non-magnetic material flange. The flange separates the housing, containing the electrical equipment, from the float that is inserted in the tank. The float automatically follows the level of the liquid, both in rising and in falling conditions. The switching of the electrical contact is quick and reliable.

## Mounting

The MEC series level switches can be installed horizontally or vertically directly in the tank, or externally in a chamber outside the tank. Square flange is specific for the naval industry.

## Wetted parts

	Flange					Float							
Steel	304SS	1	316SS	2		304SS	A	316SS	B	Monel	C	Hastelloy	D
Plastic	PVC	3	PP	4	PVDF	5	PVC	E	PP	F	PVDF	G	

## Float diameters

Steel	Ø 48	48	≥ DN50 - 2" ASME	Ø 63	63	≥ DN 65 - 2½" ASME
Plastic	Ø 50	50	≥ DN50 - 2" ASME	Ø 60	60	≥ DN 65 - 2½" ASME

**Note:** the size of the float is always subject to fluid specific gravity.

## Process connections

### Naval industry flange

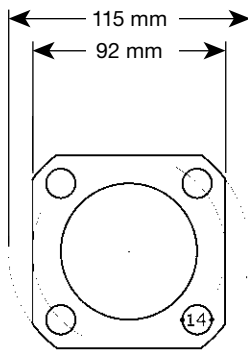

**SQ**

### Colima's standard

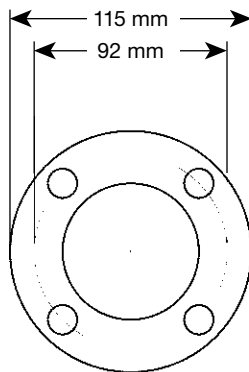

**ST**

### UNI and ASME (ANSI) flanges

UNI	PN6	PN10 / PN16	PN40	PN64
DN50	UA	UB	UC	UD
DN65	UE	UF	UG	UH
DN80	UI	UL   UM	UN	UO
DN100	UP	UQ	UR	US

ASME	150	300	600
2"	AA	AB	AC
2½"	AD	AE	AF
3"	AG	AJ	AH
4"	AI	AL	AM

Flanges are available in other sizes on request.

## Design conditions

TMA - Maximum allowable temperature	Steel	-20 to +150°C	
		with cooling extension	-20 to +350°C
	Plastic	PVC	-20 to +70°C
		PP	-20 to +105°C
PMA - Maximum allowable pressure	Steel	Colima's flange	< 16 bar g
		flange sized according to rating	< 100 bar g
	Plastic		6 bar g
Fluid specific gravity			≥ 0.8 kg/l
		only CP type	≥ 0.5 kg/l
Differential			fixed 15 mm
		only D and DV types	± 40°

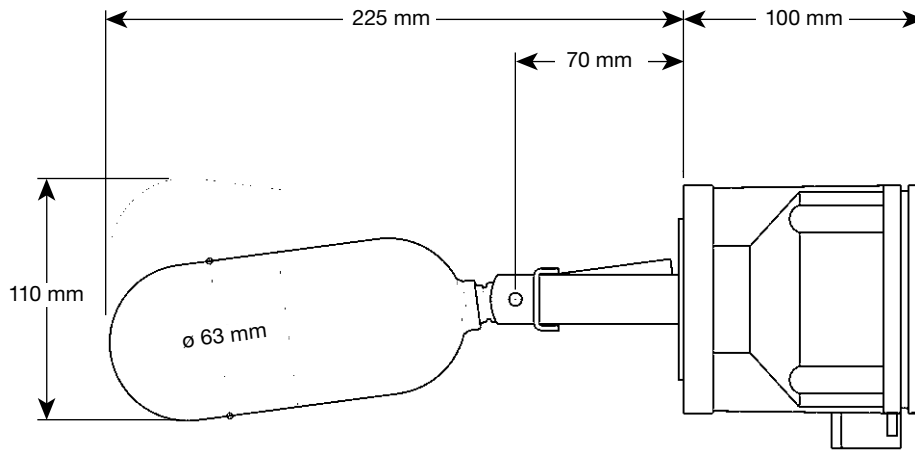

MEC type A with round flange and weatherproof housing

**Mounting accessories**

Counterflange (on request, also in other sizes)

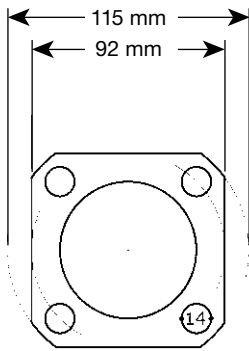

**CSQ**

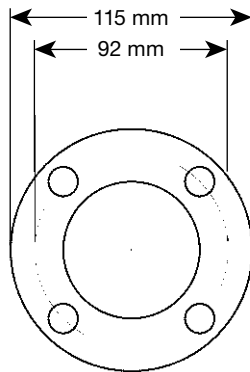

**CST**

Chamber for installation outside the tank

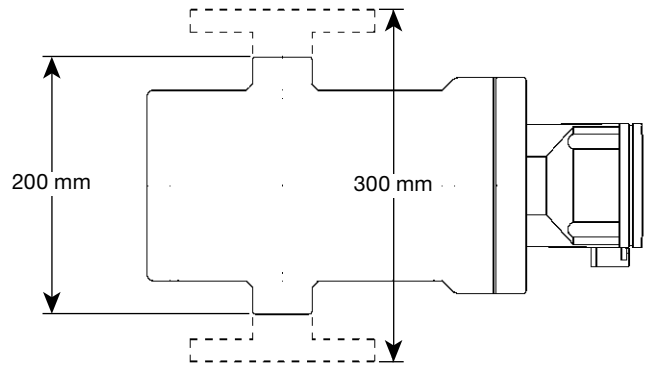

Minimum distance between connections

Flange  
300 mm  
Output  
200 mm

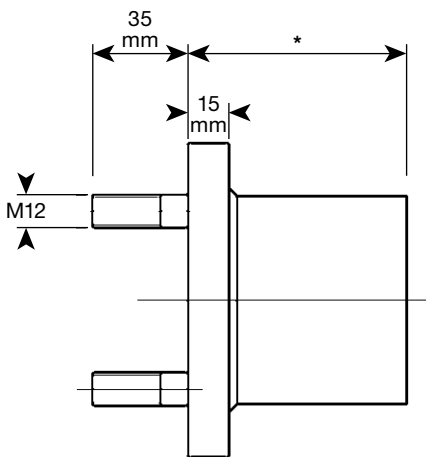

Dimensions

\*  
All types  
80 mm  
D and DV only  
35 mm

# Colima electrical equipment and housings for Colima MEC series magnetic level switches

## Description

The electrical equipment on the MEC series level switches comprises a support, including two contact holders, one fixed and one oscillating. Both parts are in polyester resin and high-insulation dielectric material with mould-resistant characteristics.

The oscillating element includes a magnet whose south pole points towards the flange that separates the electrical equipment from the liquid contained in the tank. According to the buoyancy provided by the liquid in the tank the float works by pivoting a sealed cartridge containing a magnet, with south polarity on the end towards the flange. As the two magnets on the two oscillating devices repel each other, they are never in line on the same axis. Consequently, the status of the electrical equipment switches from the normally open (NO) to normally closed (NC) position or vice versa.

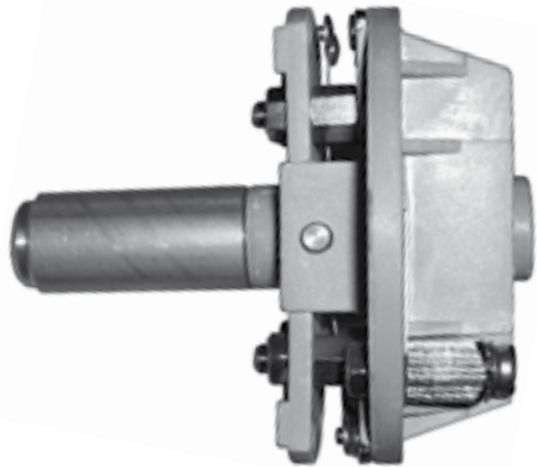

## Electrical contact characteristics

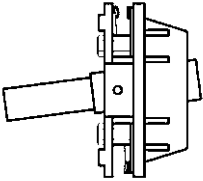
<b>Standard</b>		Standard microswitch recommended for general purpose. Gold plated contacts in open air.		<b>A</b>
		Contact coating:		
		Galvanic in gold	Standard 2 $\mu$ Special 5 $\mu$	
		Mechanical life > 10 <sup>6</sup> Electrical life > 10 <sup>4</sup>		
<b>V</b>	<b>~</b>	<b>A</b>	<b>=</b>	<b>Load</b>
220	3.0	2.0		Resistive
	1.5	0.5		Inductive
30	6.0	3.0		Resistive
	3.0	1.5		Inductive

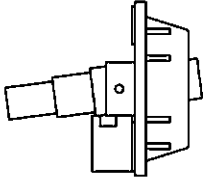
<b>Weatherproof</b>		Weatherproof microswitch. Goldplated contacts. IP66		<b>B</b>
		Nominal current	Minimum 10 mA Maximum 400 mA	
		Nominal voltage	Minimum 5 V Maximum 30 V	
<b>V</b>	<b>~</b>	<b>A</b>	<b>=</b>	
220	7	0.5		Resistive
	5	0.03		Inductive
30	7	7.0		Resistive
	5	5.0		Inductive

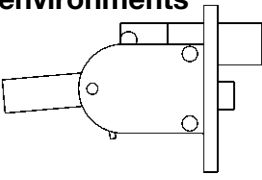
<b>For oxidising environments</b>		Microswitch indicated for oxidising or corrosive environments. Goldplated contacts hermetically sealed in inert gas.		<b>C</b>	
					
		<b>V</b>	<b>~</b>		<b>A</b>
220	1	-	0.4		Resistive
	-			Inductive	
30	3	-		Resistive	
	-		1.5	Inductive	

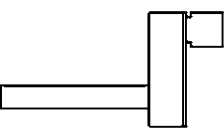

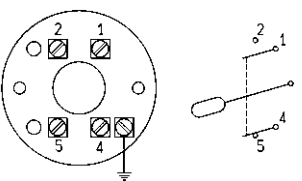
<b>For high vibrations</b>		Reed switch contact indicated for high vibrations, resists from 5 to 100 Hz. 30g 11ms. Goldplated contacts hermetically sealed in inert gas.		<b>D</b>
				
		Interruption power	60 W/VA	
Switchable current	1 A	Switchable voltage	250 V $\approx$	

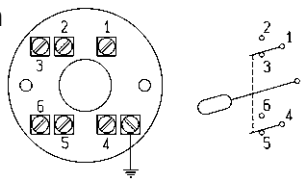
<b>SPDT execution</b>		<b>1</b>
-----------------------	---	----------

<b>DPDT execution</b> (two simultaneous SPDT contacts)		<b>2</b>
---	---	----------

## Housings

The MEC series magnetic level switch housings are available in various forms to meet all possible application needs and are suitable for most environmental and safety conditions. They are available in the weatherproof version for general use and the explosion-proof version for use in hazardous areas.

<p><b>Weatherproof housing</b></p>  <p>Type for general purpose, used in most industrial applications. In pressure die-cast aluminium and protected with polyamide paint. Protection degree IP67. One cable entry point.</p>	<b>1</b>
<p><b>Weatherproof housing</b></p>  <p>Special type adapted for low temperatures, installation in high concentration saline environments and for use in the food industry. Entirely in stainless steel. Protection degree IP67. On request IP68. Up to two cable entry points.</p>	<b>2</b>
<p><b>Explosion-proof housing</b></p>  <p>ATEX certified              ⚠ II 1/2 G EEx d IIC T5 resp. T4 for use in hazardous areas. In pressure die-cast aluminium with a polyamide paint coat. Protection degree IP67. Up to two cable entry points.</p>	<b>3</b>

## Electrical connections

The housings allow for two cable entry points which are available as follows:

Standard	G 1/2" F	<b>A</b>
Explosion-proof	Gk 1/2" F	<b>B</b>
On request	1/2" NPT F	<b>C</b>
	M 20 x1.5	<b>D</b>
	PG 13.5	<b>E</b>

## Dimensions (approximate) in mm

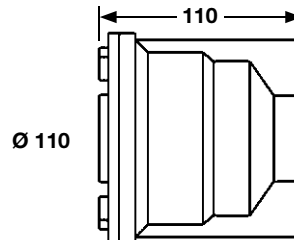
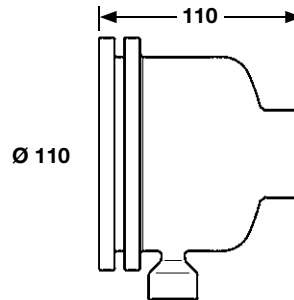
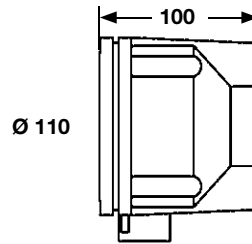

## Product selection and order placement

Each unit is identified by a unique alphanumeric code that defines the manufacturing characteristics that best suits the application.

Range	Colima		Colima
<b>Model</b>	<b>M</b>	MEC	<b>M</b>
<b>Type</b>	<b>A</b>	Standard	<b>A</b>
	<b>AT</b>	With cooling extension	
	<b>CP</b>	Liquids with specific gravity > 0.5 kg/l	
	<b>D</b>	Adjustable differential range in 2 directions	
	<b>DV</b>	Adjustable differential range in 1 direction, vertical mount	
	<b>AV</b>	High vibration application	
	<b>M</b>	With protection bellows	
	<b>O</b>	Vertical on sunken tanks, high or low level	
	<b>PN</b>	Pneumatic output	
	<b>L</b>	Vertical foam and specialist applications	
	<b>S</b>	Horizontal foam and specialist applications	
<b>T</b>	With field verification device		
<b>MM</b>	Miniature type		
<b>Flange</b>	<b>F</b>	Flanged	<b>F</b>
<b>Flange material</b>	<b>1</b>	304 stainless steel	<b>1</b>
	<b>2</b>	316 stainless steel	
	<b>3</b>	PVC	
	<b>4</b>	PP	
	<b>5</b>	PVDF	
<b>Flange rating</b>	Refer to page 3		<b>UA</b>
<b>Float</b>	<b>A</b>	304 stainless steel	<b>B</b>
	<b>B</b>	316 stainless steel	
	<b>C</b>	Monel	
	<b>D</b>	Hastelloy	
	<b>E</b>	PVC	
	<b>F</b>	PP	
	<b>G</b>	PVDF	
<b>Float diameter</b>	<b>48</b>	Ø 48 steel (>DN50 - 2" ASME)	<b>48</b>
	<b>63</b>	Ø 63 steel (>DN65 - 2½" ASME)	
	<b>50</b>	Ø 50 plastic (>DN50 - 2" ASME)	
	<b>60</b>	Ø 60 plastic (>DN65 - 2½" ASME)	
<b>Housing</b>	<b>1</b>	IP67 General purpose	<b>1</b>
	<b>2</b>	IP67 Stainless steel	
	<b>3</b>	ATEX certified	
<b>Electrical connections</b>	<b>1</b>	G ½"F	<b>1</b>
	<b>2</b>	Gk ½"F	
	<b>3</b>	½"NPT F	
	<b>4</b>	M20 x 1.5	
	<b>5</b>	PG 13.5	
<b>Electrical equipment</b>	<b>A1</b>	Standard SPDT	<b>A1</b>
	<b>A2</b>	Standard DPDT	
	<b>B1</b>	Weather proof SPDT	
	<b>B2</b>	Weather proof DPDT	
	<b>C1</b>	Ermetically sealed SPDT	
	<b>C2</b>	Ermetically sealed DPDT	
	<b>D1</b>	High vibrations SPDT	

**How to order example:** 1 off Spirax Sarco Colima M-A-F-1-UA-B-48-1-1-A1