



# CA14 SG Iron Air and Gas Trap DN15 to DN25 (Flanged)

## Description

The CA14 is a range of float type automatic liquid drainers for air and gas systems. The body and cover are of SG iron and the complete unit is readily maintainable. The cover will be drilled and tapped ½" BSP or NPT for the purpose of fitting a balance line. The standard version with a Viton valve cone is designated CA14 (DN15 and DN20 only). A stainless steel valve cone version is designated CA14S. Both are available with horizontal flanged connections with flow from right to left CA14 (R-L) or from left to right CA14 (L-R).

## Standards

The product fully complies with the requirements of the Pressure Equipment Directive (PED).

## Certification

The product is available with a manufacturer's Typical Test Report.

**Note:** All certification/inspection requirements must be stated at the time of order placement.

## Sizes and pipe connections

DN15, DN20 and DN25.

Flanged EN 1092 PN16, ASME 150 and JIS/KS 10K.

## CA14 (R-L)

DN15 and DN20 shown

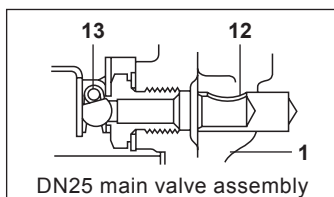
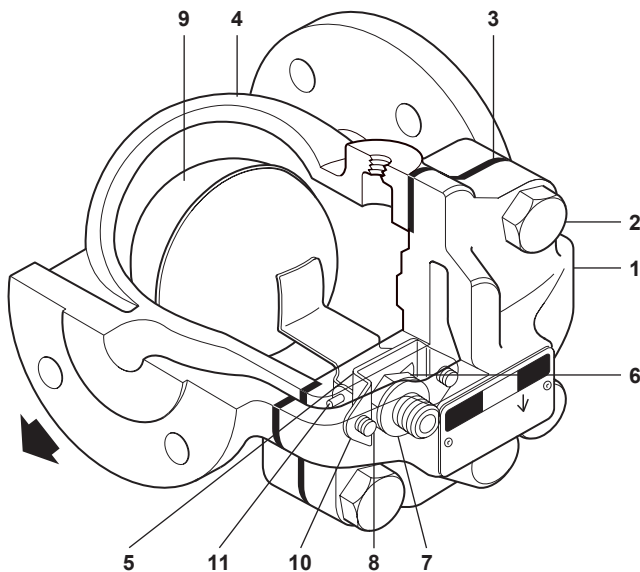

## Materials

No.	Part	Material			
* 1	Body	SG iron	EN-GJS-400-15, EN 1563, EN JS1030 (GGG 40.3)		
		2	Cover bolts	Steel	BS 3692 Gr. 8.8
		3	Cover gasket	Reinforced exfoliated graphite	
4	Cover	SG iron	EN-GJS-400-15, EN 1563, EN JS1030 (GGG 40.3)		
		5	Main valve cone	CA14 Synthetic rubber CA14S Stainless steel	Viton AISI 440B
6	Main valve seat	Stainless steel	BS 970 431 S29		
7	Main valve seat gasket	Stainless steel	BS 1449 304 S11		
8	Main valve assembly screws	Stainless steel	BS 6105 CI A2-70		
9	Ball float and lever	Stainless steel	BS 1449 304 S16		
10	Pivot frame	Stainless steel	BS 1449 304 S16		
11	Pivot pin	Stainless steel			
* 12	Erosion deflector (DN25 only)	Stainless steel	BS 970 431 S29		
* 13	Valve spring (DN25 only)	Stainless steel	BS 2056 302 S26		

**Note:** Item 12 is pressed into item 1 (DN25 only).

## Pressure/temperature limits

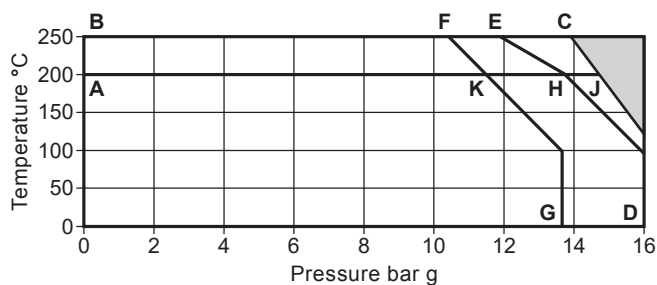

The product **must not** be used in this region.

**A - J - D** CA14 flanged PN16

**A - K - G** CA14 flanged JIS/KS 10K

**A - H - D** CA14 flanged ASME 150

**B - C - D** CA14S flanged PN16

**B - F - G** CA14S flanged JIS/KS 10K

**B - E - D** CA14S flanged ASME 150

Body design conditions	PN16	
PMA Maximum allowable pressure	16 bar g @ 120 °C	
TMA Maximum allowable temperature	250 °C @ 14 bar g	
Minimum allowable temperature	0 °C	
PMO Maximum operating pressure	16 bar g @ 120 °C	
TMO Maximum operating temperature	<b>CA14</b>	200 °C @ 14.7 bar g
	<b>CA14S</b>	250 °C @ 13.9 bar g
Minimum operating temperature	0 °C	
ΔPMX Maximum differential pressure bar, depending on the specific gravity of the liquid being drained:	<b>Specific gravity</b>	<b>1.0</b> <b>0.9</b> <b>0.8</b> <b>0.7</b> <b>Min. 0.6</b>
	<b>ΔPMX bar</b>	14.0   14.0   14.0   9.0   5.0
ΔPMX Minimum differential pressure	0.1 bar	
Designed for a maximum cold hydraulic test pressure of 24 bar g		

## Capacities

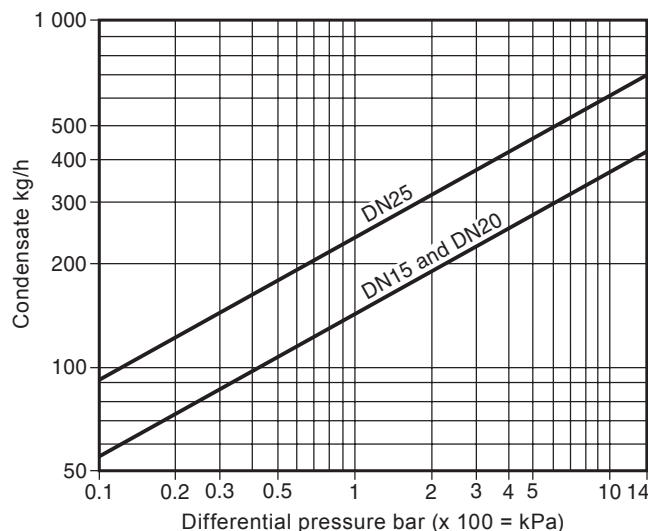

## Safety information, installation and maintenance

For full details see the Installation and Maintenance Instructions (IM-P148-13) supplied with the product.

### Installation note:

The CA14 must be installed with the direction of flow as indicated on the body, and with the float arm in a horizontal plain so that it rises and falls vertically.

### Disposal

If a product which contains a Viton component has been subjected to a temperature approaching 315 °C or higher, then it may have decomposed and formed hydrofluoric acid. Avoid skin contact and inhalation of any fumes as the acid will cause deep skin burns and damage to the respiratory system. Viton must be disposed of in a recognised manner as stated in the Installation and Maintenance Instructions. No other ecological hazard is anticipated with the disposal of this product providing due care is taken.

### How to order

**Example:** 1 off Spirax Sarco DN15 CA14 with SG iron body with cover flanged to EN 1092 PN16. **Note:** Unless specified at the time of ordering, a right to left flow will be supplied e.g. CA14 (R-L).

## Dimensions/weights (approximate) in mm and kg

Size	DIN/ASME	JIS/KS	B	C	D	E	F	G	Weight
	A	A							
DN15	150	150	107	101	51	47	26.5	115	4.5
DN20	150	150	107	101	55	47	26.5	115	5.0
DN25	160	170	117	70	100	10	21.0	120	6.5

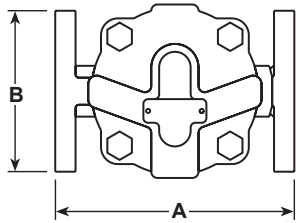

DN15 and DN20

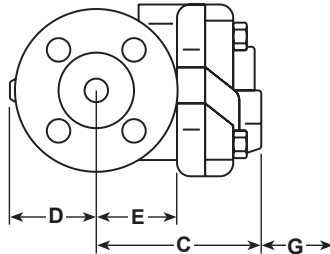

DN25

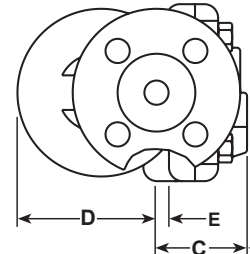

Withdrawal distance

Withdrawal distance

## Spare parts

The spare parts available are shown in solid outline. Parts drawn in a grey line are not supplied as spares.

### Available spares



Maintenance kit	CA14	3, 5+9, 6, 7, 8 (2 off), 10, 11
Seal kit	CA14S	3, 5+9, 6, 7, 8 (2 off), 10, 11, 13 (DN25 only)
	CA14	3, 5

### How to order spares

Always order spares by using the description given in the column headed 'Available spares' and state the size and type of trap.

**Example:** 1 off Maintenance kit for a Spirax Sarco DN15 CA14 air and gas trap.

### Recommended tightening torques

Item	 or mm		N m
2	17 A/F	M10 x 30	47 - 50
5	17 A/F	M12 x 12	50 - 55
8	Pozidrive	M4 x 6	2.5 - 3.0

\* **Note:** Item 2 is not an available spare.

