

spirax sarco

BCV

TI-P403-102
EMM Issue 7

Blowdown Control Valves DN15 to DN50 (½" to 2")

Description

Spirax Sarco's BCV blowdown control valves are manufactured using the market proven Spira-trol™ body. These valves are designed for the blowdown of steam boilers or for other high pressure drop, low flow applications, and are generally used with a blowdown controller as part of an automatic BCV control system.

The flowrate is adjusted by setting the stroke of the valve spindle.

These valves have been specially designed to minimize seat erosion and ensure consistent tight shut-off.

A ¼" BSP plug at the base of the valve may be removed to allow a sample cooler to be fitted.

Two versions are available:

- Electrically actuated BCV blowdown control valve.
- Pneumatically actuated BCV blowdown control valve.

Available models:

Material	Connections			
	Screwed	Socket weld	Flanged	Butt weld
Carbon steel	BCV41	BCV42	BCV43	BCV44
Stainless steel	BCV61	BCV62	BCV63	BCV64
SG iron	BCV71		BCV73	
Alloy steel		BCV82	BCV83	BCV84

Spira-trol™ valve body options:

Stem sealing	Graphite packing	High temperature applications
Seating	Hard facing	316L stainless steel with Stellite 6 facing

BCV blowdown control valves are compatible with the following actuators:

Version	Actuator
Electric	AEL3 series
Pneumatic	PN9_ _ _ series

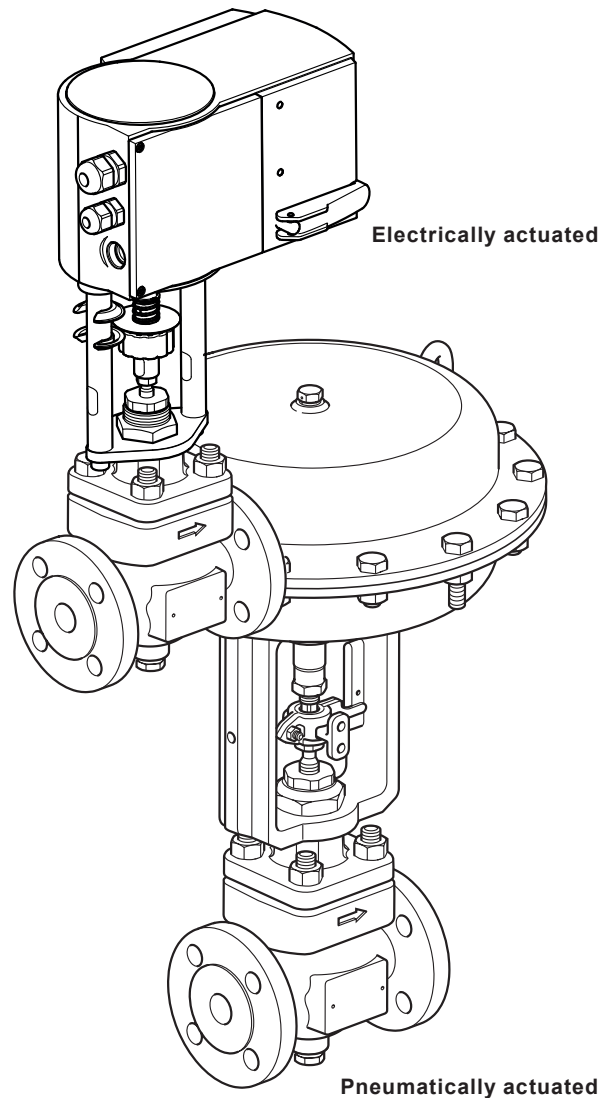

Operation

BCV blowdown control valves are supplied loaded to the closed position.

Electrical version: When the power is connected to the actuator the valve opens to the position set by the internal limit switch.

Pneumatic version: When the solenoid valve opens, air is admitted to the actuator activating the valve to open to the selected stroke.

Standards

These products fully comply with the requirements of the EU Pressure Equipment Directive/UK Pressure Equipment (Safety) Regulations.

The Electric actuator complies with LV Directive 2014/35/EU, EN60730-1, EN60730-2-14 and with EMC Directive 2014/30/EU, EN61000-6-2, EN6100-6-4

Certification

These products are available with material certification to EN 10204 3.1.

Note: All certification/inspection requirements must be stated at the time of order placement.

Size and pipe connections

½", ¾", 1", 1¼", 1½" and 2" Screwed BSP or NPT, Socket weld and Butt weld.

DN15, DN20, DN25, DN32, DN40 and DN50 Flanged:

EN 1092 PN25, PN40, PN63 and PN100

ASME class 125, 150, 250, 300 and 600

JIS/KS 10K, 20K, 30K and 40K

Materials

No.	Part	Material
1	Body	Carbon steel 1.0619+N/WCB
		Stainless steel 1.4408/CF8M
		SG iron EN-GJS-400-18-LT/A395
		Alloy steel 1.7357/WC6
2	Bonnet	Forged steel 1.0460/A105N or 1.0619/WCB
		Stainless steel 1.4408/CF8M
		SG iron EN-GJS-400-18-LT/A395
		Alloy steel 1.7357/WC6
3	Seat retainer	Stainless steel 316L
4	Seat	Stainless steel 316L with Stellite
5	Plug	Stainless steel 316L with Stellite

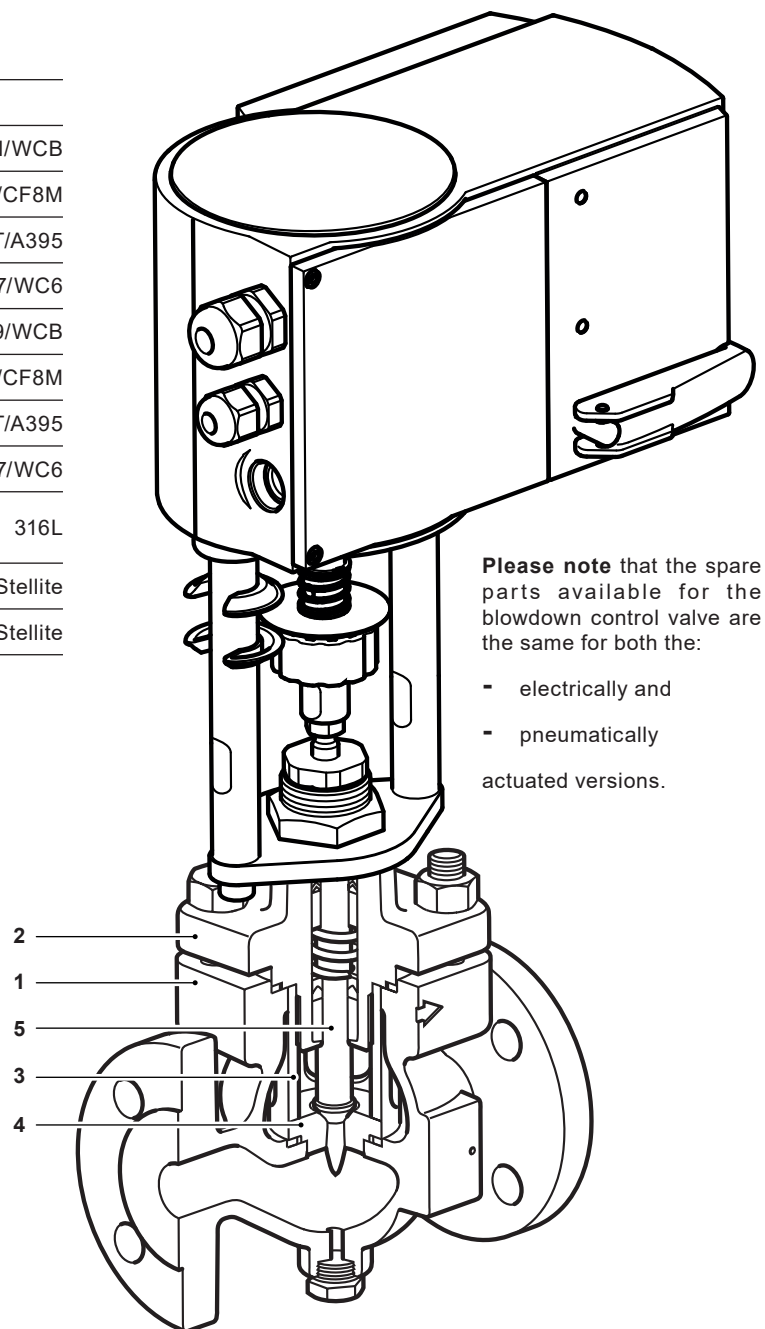

Electrical data

Actuator	AEL3 series
Supply voltage	Standard 24 Vac/dc, Optional card 230 Vac and 110 Vac
Supply frequency	50 to 60 Hz
Power consumption	12W (24 Vac/dc) 28W (230 Vac, 110 Vac)
Actuator speed	2 mm/s, 4 mm/s or 6 mm/s
Actuators thrust maximum	2 kN

Size	Actuator	Maximum shut-off value
DN15 to DN25 ½" to 1"	AEL3 series/PN9123E-B	103.4 bar g @100 °C
DN32 to DN50 1¼" to 2"	AEL3 series/PN9223E-B	

Warnings:

If the temperature of the medium in the valve is high, the drive columns and the shaft may also reach high temperatures.

High Temperature Extension:

The extension kit is to be used on applications above 130 °C to up to 240 °C. There are two kit options of up to 180 °C and another for up to 240 °C

1. Unscrew the actuator mounting plate screws for pillars.
2. Screw the extension pillars into actuator pillars and tighten to 12 Nm.
3. Screw the actuator mounting plate screws into pillars and tighten to 25 Nm.
4. Mount the coupling extension into the actuator coupling until it snaps closed.

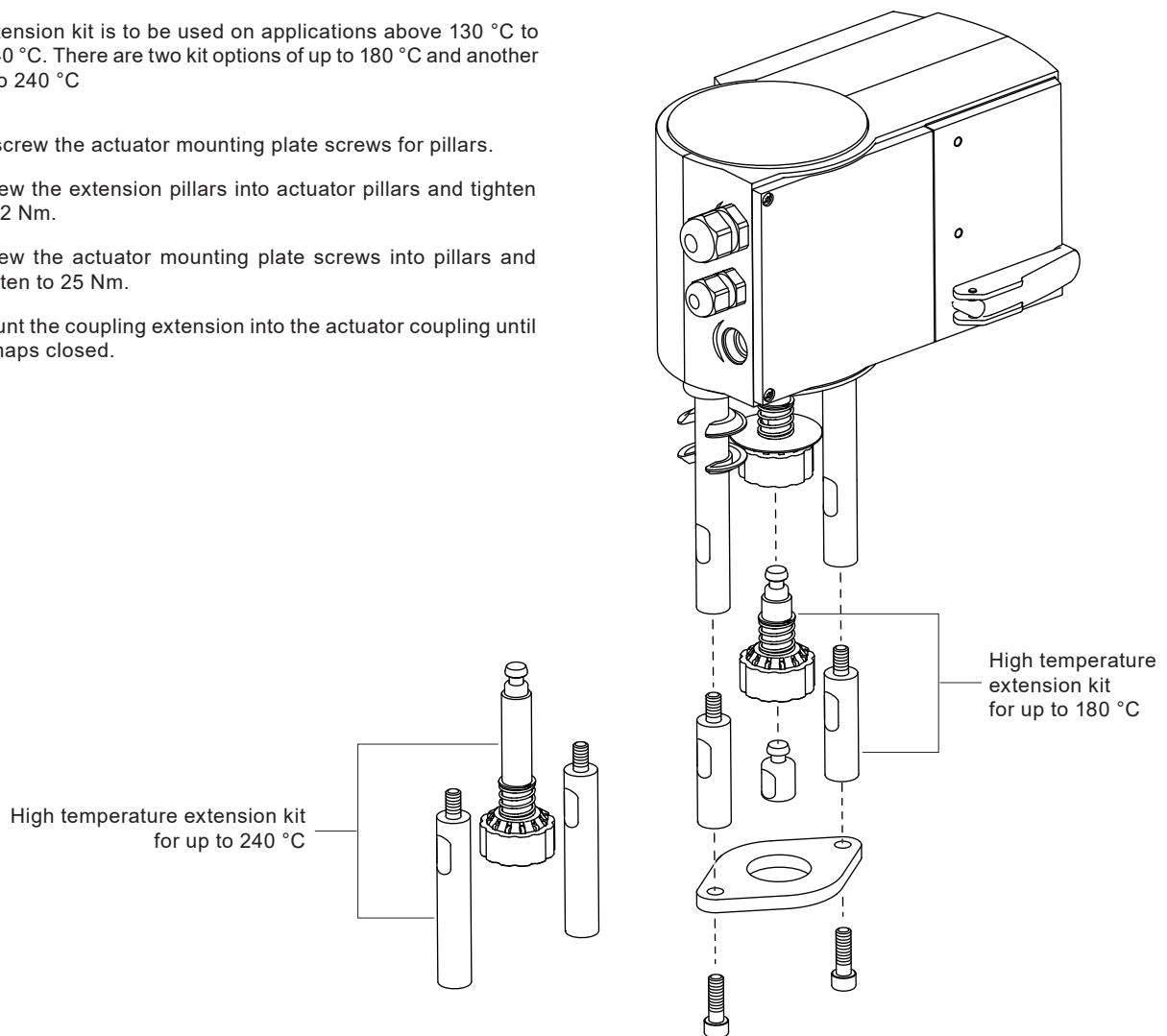

Pressure/temperature limits – BCV4_

Body design conditions:		PN40, PN63 or PN100	JIS/KS 20K, 30K or 40K	ASME class 150, class 300 or ASME class 600	
PMA	Maximum allowable pressure	EN	PN40	40 bar g @ 50 °C	
			PN63	63 bar g @ 50 °C	
			PN100	100 bar g @ 50 °C	
	ASME	ASME 150	19.6 bar g @ 38 °C	284 psi g @ 100 °F	
		ASME 300	51.1 bar g @ 38 °C	741 psi g @ 100 °F	
		ASME 600	102.1 bar g @ 38 °C	1480 psi g @ 100 °F	
	JIS / KS	JIS/KS 20K	34 bar g @ 120 °C		
		JIS/KS 30K	51 bar g @ 120 °C		
		JIS/KS 40K	68 bar g @ 120 °C		
TMA	Maximum allowable temperature	EN	PN40	300 °C @ 27.6 bar g	
			PN63	400 °C @ 37.5 bar g	
			PN100	400 °C @ 59.5 bar g	
	ASME	ASME 150	425 °C @ 5.5 bar g	797 °F @ 80 psi g	
		ASME 300	425 °C @ 28.8 bar g	797 °F @ 418 psi g	
		ASME 600	425 °C @ 57.5 bar g	797 °F @ 834 psi g	
	JIS / KS	JIS/KS 20K	300 °C @ 20 bar g		
		JIS/KS 30K	425 °C @ 30 bar g		
		JIS/KS 40K	425 °C @ 40 bar g		
Minimum allowable temperature	EN	PN40	-10 °C		
		PN63	-29 °C		
		PN100	-29 °C		
	ASME	ASME 150	-29 °C	-20 °F	
		ASME 300	-29 °C	-20 °F	
		ASME 600	-29 °C	-20 °F	
	JIS / KS	JIS/KS 20K	-10 °C		
		JIS/KS 30K	-29 °C		
		JIS/KS 40K	-29 °C		
PMO	Maximum operating pressure for saturated steam service	EN	PN40	31.1 bar g @ 237 °C	
			PN63	47.0 bar g @ 261 °C	
			PN100	70.8 bar g @ 287 °C	
	ASME	ASME 150	13.9 bar g @ 197 °C	201 psi g @ 386 °F	
		ASME 300	41.7 bar g @ 254 °C	605 psi g @ 489 °F	
		ASME 600	80.0 bar g @ 295 °C	1160 psi g @ 563 °F	
	JIS / KS	JIS/KS 20K	30.6 bar g @ 236 °C		
		JIS/KS 30K	44.6 bar g @ 258 °C		
		JIS/KS 40K	58.5 bar g @ 276 °C		
TMO	Maximum operating temperature	EN	PN40	300 °C @ 27.6 bar g	
			PN63	400 °C @ 37.5 bar g	
			PN100	400 °C @ 59.5 bar g	
	ASME	ASME 150	425 °C @ 5.5 bar g	797 °F @ 80 psi g	
		ASME 300	425 °C @ 28.8 bar g	797 °F @ 418 psi g	
		ASME 600	425 °C @ 57.5 bar g	797 °F @ 834 psi g	
	JIS / KS	JIS/KS 20K	300 °C @ 20 bar g		
		JIS/KS 30K	425 °C @ 30 bar g		
		JIS/KS 40K	425 °C @ 40 bar g		
Minimum operating temperature	EN	PN40	-10 °C		
		PN63	-29 °C		
		PN100	-29 °C		
	ASME	ASME 150	-29 °C	-20 °F	
		ASME 300	-29 °C	-20 °F	
		ASME 600	-29 °C	-20 °F	
	JIS / KS	JIS/KS 20K	-10 °C		
		JIS/KS 30K	-29 °C		
		JIS/KS 40K	-29 °C		

Designed for a maximum cold hydraulic test pressure of:

1.5 x PMA of the relative end connection of choice

Pressure/temperature limits – BCV4_

**BCV41 Screwed BSP
BCV43 Flanged EN 1092**

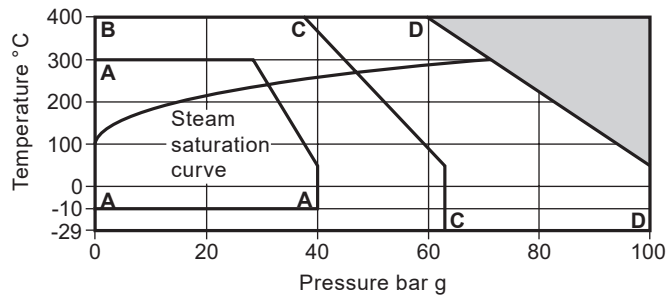

- The product **must not** be used in this region.
- A - B** Flanged EN 1092 PN40 and Screwed BSP
- B - C** Flanged EN 1092 PN63
- B - D** Flanged EN 1092 PN100

**BCV41 Screwed NPT
BCV42 Socket weld
BCV43 Flanged ASME
BCV44 Butt weld**

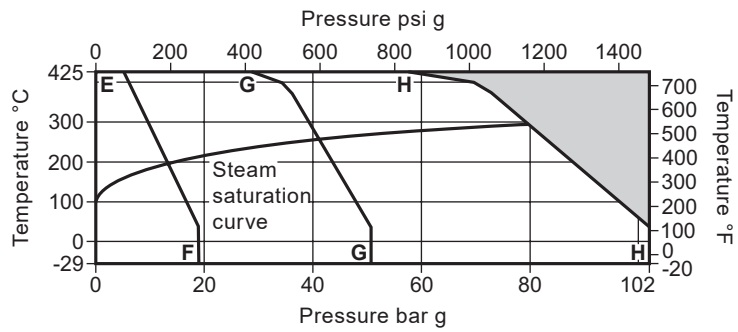

- The product **must not** be used in this region.
- E - F** Flanged ASME class 150
- E - G** Flanged ASME class 300, Screwed NPT and Socket weld class 3000 (B 16.11)
- E - H** Flanged ASME class 600, Socket weld class 6000 (B 16.11) and Butt weld

BCV43 Flanged JIS/KS

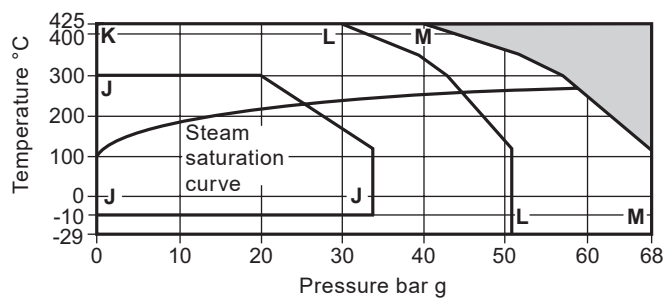

- The product **must not** be used in this region.
- J - J** Flanged JIS/KS 20K
- K - K** Flanged JIS/KS 30K
- L - L** Flanged JIS/KS 40K

Pressure/temperature limits – BCV6_

Body design conditions:		PN40, PN63 or PN100	ASME class 150, class 300 or ASME class 600	
		JIS/KS 20K, 30K or 40K		
PMA	EN	PN40	40 bar g @ 100 °C	
		PN63	63 bar g @ 100 °C	
		PN100	100 bar g @ 100 °C	
	ASME	ASME 150	19.0 bar g @ 38 °C	275 psi g @ 100 °F
		ASME 300	49.6 bar g @ 38 °C	719 psi g @ 100 °F
		ASME 600	99.3 bar g @ 38 °C	1440 psi g @ 100 °F
	JIS / KS	JIS/KS 20K	34 bar g @ 120 °C	
		JIS/KS 30K	51 bar g @ 120 °C	
		JIS/KS 40K	68 bar g @ 120 °C	
TMA	EN	PN40	400 °C @ 27.4 bar g	
		PN63	580 °C @ 39.5 bar g	
		PN100	580 °C @ 62.7 bar g	
	ASME	ASME 150	538 °C @ 1.4 bar g	1000 °F @ 20 psi g
		ASME 300	538 °C @ 25.2 bar g	1000 °F @ 365 psi g
		ASME 600	538 °C @ 50.0 bar g	1000 °F @ 725 psi g
	JIS / KS	JIS/KS 20K	425 °C @ 20 bar g	
		JIS/KS 30K	490 °C @ 30 bar g	
		JIS/KS 40K	490 °C @ 40 bar g	
Minimum allowable temperature	EN	PN40	-10 °C	
		PN63	-29 °C	
		PN100	-29 °C	
	ASME	ASME 150	-29 °C	-20 °F
		ASME 300	-29 °C	-20 °F
		ASME 600	-29 °C	-20 °F
	JIS / KS	JIS/KS 20K	-10 °C	
		JIS/KS 30K	-29 °C	
		JIS/KS 40K	-29 °C	
PMO	EN	PN40	32.2 bar g @ 240 °C	
		PN63	49.2 bar g @ 264 °C	
		PN100	75.1 bar g @ 291 °C	
	ASME	ASME 150	13.8 bar g @ 197 °C	200 psi g @ 386 °F
		ASME 300	33.8 bar g @ 242 °C	490 psi g @ 467 °F
		ASME 600	64.6 bar g @ 281 °C	937 psi g @ 538 °F
	JIS / KS	JIS/KS 20K	30.6 bar g @ 236 °C	
		JIS/KS 30K	44.6 bar g @ 258 °C	
		JIS/KS 40K	58.5 bar g @ 276 °C	
TMO	EN	PN40	400 °C @ 27.4 bar g	
		PN63	580 °C @ 39.5 bar g	
		PN100	580 °C @ 62.7 bar g	
	ASME	ASME 150	538 °C @ 1.4 bar g	1000 °F @ 20 psi g
		ASME 300	538 °C @ 25.2 bar g	1000 °F @ 365 psi g
		ASME 600	538 °C @ 50.0 bar g	1000 °F @ 725 psi g
	JIS / KS	JIS/KS 20K	425 °C @ 20 bar g	
		JIS/KS 30K	490 °C @ 30 bar g	
		JIS/KS 40K	490 °C @ 40 bar g	
Minimum operating temperature	EN	PN40	-10 °C	
		PN63	-29 °C	
		PN100	-29 °C	
	ASME	ASME 150	-29 °C	-20 °F
		ASME 300	-29 °C	-20 °F
		ASME 600	-29 °C	-20 °F
	JIS / KS	JIS/KS 20K	-10 °C	
		JIS/KS 30K	-29 °C	
		JIS/KS 40K	-29 °C	

Designed for a maximum cold hydraulic test pressure of:

1.5 x PMA of the relative end connection of choice

Pressure/temperature limits – BCV6_

**BCV61 Screwed BSP
BCV63 Flanged EN 1092**

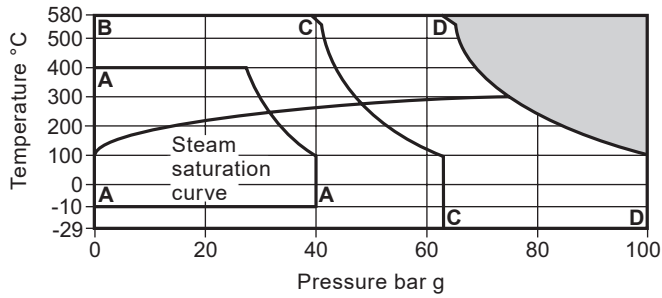

- The product **must not** be used in this region.
- A - B** Flanged EN 1092 PN40 and Screwed BSP
- B - C** Flanged EN 1092 PN63
- B - D** Flanged EN 1092 PN100

**BCV61 Screwed NPT
BCV62 Socket weld
BCV63 Flanged ASME
BCV64 Butt weld**

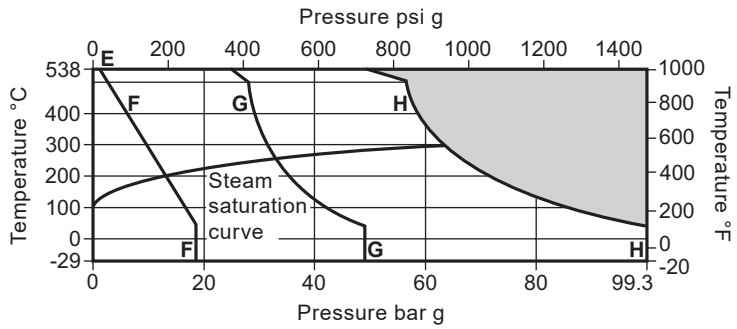

- The product **must not** be used in this region.
- E - F** Flanged ASME class 150
- E - G** Flanged ASME class 300, Screwed NPT and Socket weld class 3000 (B 16.11)
- E - H** Flanged ASME class 600, Socket weld and Butt weld class 6000 (B 16.11)

BCV63 Flanged JIS / KS

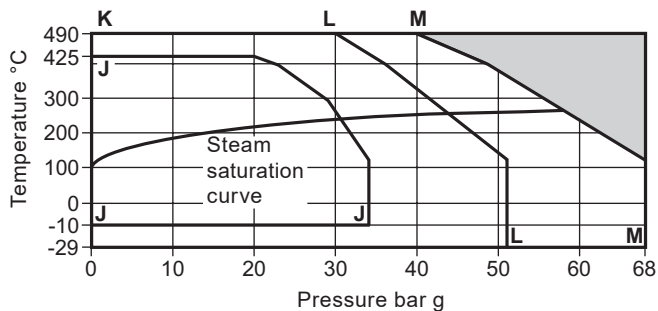

- The product **must not** be used in this region.
- J - J** Flanged JIS/KS 20K
- K - L** Flanged JIS/KS 30K
- K - M** Flanged JIS/KS 40K

Pressure/temperature limits – BCV7_

Body design conditions:			PN25	ASME class 125 or ASME class 250	
			JIS/KS 10K		
PMA	Maximum allowable pressure	EN	PN25	25.0 bar g @ 120 °C	
		ASME	ASME 125	11.5 bar g @ 140 °C	166 psi g @ 284 °F
			ASME 250	26.7 bar g @ 140 °C	387 psi g @ 284 °F
		JIS / KS	JIS/KS 10K	13.7 bar g @ 120 °C	
TMA	Maximum allowable temperature	EN	PN25	300 °C @ 20 bar g	
		ASME	ASME 125	232 °C @ 8.6 bar g	449 °F @ 125 psi g
			ASME 250	232 °C @ 17.2 bar g	449 °F @ 249 psi g
		JIS / KS	JIS/KS 10K	300 °C @ 9.8 bar g	
Minimum allowable temperature		EN	PN25	-10 °C	
		ASME	ASME 125	-29 °C	-20 °F
			ASME 250	-29 °C	-20 °F
		JIS / KS	JIS/KS 10K	-10 °C	
PMO	Maximum operating pressure for saturated steam service	EN	PN25	22.5 bar g @ 220 °C	
		ASME	ASME 125	10.0 bar g @ 184 °C	145 psi g @ 363 °F
			ASME 250	18.0 bar g @ 209 °C	261 psi g @ 408 °F
		JIS / KS	JIS/KS 10K	12.3 bar g @ 191 °C	
TMO	Maximum operating temperature	EN	PN25	300 °C @ 20.0 bar g	
		ASME	ASME 125	232 °C @ 8.6 bar g	449 °F @ 125 psi g
			ASME 250	232 °C @ 17.2 bar g	449 °F @ 249 psi g
		JIS / KS	JIS/KS 10K	300 °C @ 9.8 bar g	
Minimum operating temperature		EN	PN25	-10 °C	
		ASME	ASME 125	-29 °C	-20 °F
			ASME 250	-29 °C	-20 °F
		JIS / KS	JIS/KS 10K	-10 °C	

Designed for a maximum cold hydraulic test pressure of:

1.5 x PMA of the relative end connection of choice

Pressure/temperature limits – BCV7_

**BCV71 Screwed BSP
BCV73 Flanged EN 1092**

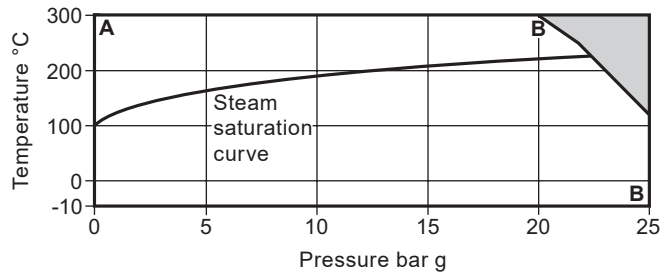

 The product **must not** be used in this region.
A - B Flanged EN 1092 PN25 and Screwed BSP

**BCV71 Screwed NPT
BCV73 Flanged ASME**

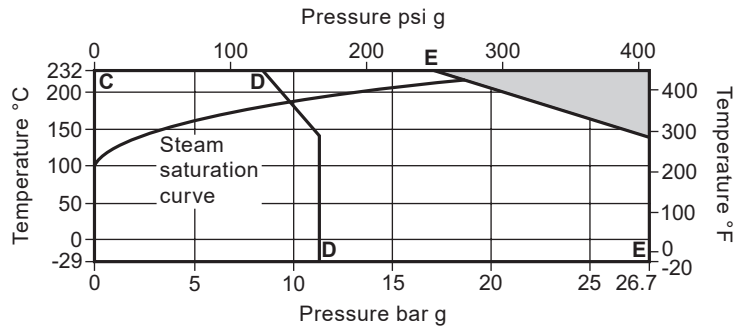

 The product **must not** be used in this region.
C - D Flanged ASME class 125
C - E Flanged ASME class 250 and Screwed NPT

BCV73 Flanged JIS/KS

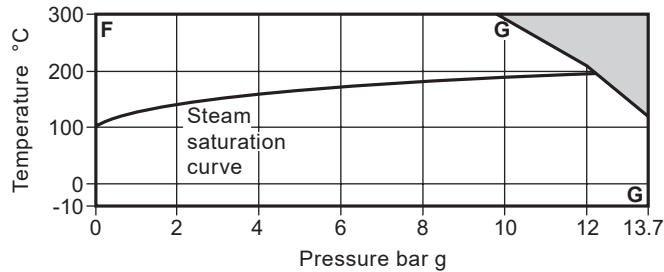

 The product **must not** be used in this region.
F - G Flanged JIS/KS 10K

Pressure/temperature limits – BCV8_

Body design conditions:		PN63 or PN100		ASME class 600	
		JIS/KS 30K or 40K			
PMA	Maximum allowable pressure	EN	PN63	63 bar g @ 300 °C	
			PN100	100 bar g @ 300 °C	
	ASME	ASME 600	103.4 bar g @ 50 °C	1500 psi g @ 122 °F	
	JIS / KS	JIS/KS 30K	51 bar g @ 120 °C		
		JIS/KS 40K	68 bar g @ 120 °C		
	TMA	Maximum allowable temperature	EN	PN63	490 °C @ 42.8 bar g
PN100				490 °C @ 68.0 bar g	
ASME		ASME 600	538 °C @ 29.8 bar g	1000 °F @ 432 psi g	
JIS / KS		JIS/KS 30K	490 °C @ 30.0 bar g		
		JIS/KS 40K	510 °C @ 40.0 bar g		
Minimum allowable temperature		EN	PN63	-29 °C	
	PN100		-29 °C		
	ASME	ASME 600	-29 °C	-20 °F	
	JIS / KS	JIS/KS 30K	-29 °C		
		JIS/KS 40K	-29 °C		
	PMO	Maximum operating pressure for saturated steam service	EN	PN63	63.0 bar g @ 280 °C
PN100				99.0 bar g @ 310 °C	
ASME		ASME 600	85.7 bar g @ 300 °C	1243 psi g @ 572 °F	
JIS / KS		JIS/KS 30K	44.6 bar g @ 257 °C		
		JIS/KS 40K	58.6 bar g @ 274 °C		
TMO		Maximum operating temperature	EN	PN63	490 °C @ 42.8 bar g
	PN100			490 °C @ 68.0 bar g	
	ASME	ASME 600	538 °C @ 29.8 bar g	1000 °F @ 432 psi g	
	JIS / KS	JIS/KS 30K	490 °C @ 30.0 bar g		
		JIS/KS 40K	510 °C @ 40.0 bar g		
	Minimum operating temperature	EN	PN63	-29 °C	
PN100			-29 °C		
ASME		ASME 600	-29 °C	-20 °F	
JIS / KS		JIS/KS 30K	-29 °C		
		JIS/KS 40K	-29 °C		

Designed for a maximum cold hydraulic test pressure of:

1.5 x PMA of the relative end connection of choice

Pressure/temperature limits – BCV8_

BCV83 Flanged EN 1092

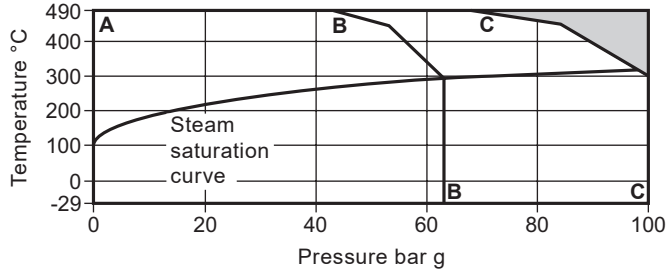

 The product **must not** be used in this region.
A - B Flanged EN 1092 PN63
A - C Flanged EN 1092 PN100

BCV82 Socket weld
 BCV83 Flanged ASME
 BCV84 Butt weld

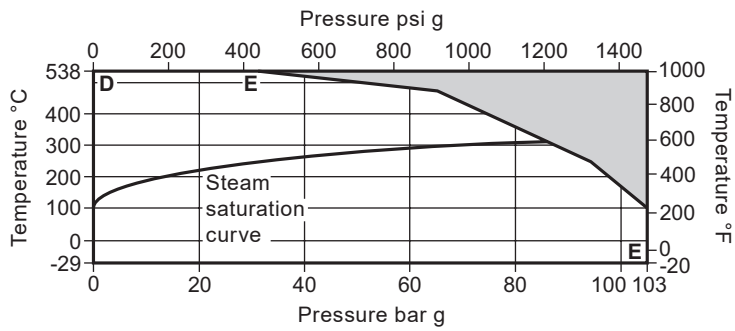

 The product **must not** be used in this region.
D - E Flanged ASME class 600, socket weld and butt weld

BCV83 Flanged JIS/KS

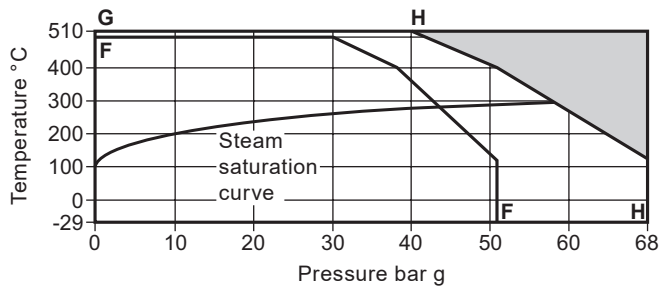

 The product **must not** be used in this region.
F - F Flanged JIS/KS 20K
G - H Flanged JIS/KS 30K

Kvs values

Valve size	DN15	DN20	DN25	DN32	DN40	DN50
Kvs value	0.5	0.5	0.5	1.6	1.6	1.6

For conversion: C_v (UK) = $K_v \times 0.963$ C_v (US) = $K_v \times 1.156$

Size	ASME	PN		DN 15	DN 20	DN 25	DN 32	DN 40	DN 50
A	125		JIS/KS 10K	-	-	184	-	222	254
	300		JIS/KS 20K	190.5		197	-	235	267
	600		JIS/KS 30K	203	206	210	251	251	286
			JIS/KS 40K						
		40		130	150	160	180	200	230
		100		210	230		260	260	300
B	125		JIS/KS 10K	392			421	416	
	300		JIS/KS 20K	392			421	416	
	600	40	JIS/KS 30K	422			449		
			100	JIS/KS 40K	422			449	
B1	125		JIS/KS 10K	378			432	427	
	300		JIS/KS 20K	378			432	427	
	600	40	JIS/KS 30K	408			460		
			100	JIS/KS 40K	408			460	
C			230						
C1				170			300		
D	125		JIS/KS 10K	42.5	57.0	54.5	65.5	76.5	84.5
	300		JIS/KS 20K	42.5	57.0	54.5	65.5	76.5	84.5
	600	40	JIS/KS 30K	49.5		56.5	71.5	85.5	
			100	JIS/KS 40K	49.5		56.5	71.5	85.5
Weight									
Electric version	125		JIS/KS 10K	12	12.8	13	19.5	20	23
	300		JIS/KS 20K	12	12.8	13	19.5	20	23
	600	40	JIS/KS 30K	16	18	19	25	28	33
			100	JIS/KS 40K	16	18	19	25	28
Pneumatic version	125		JIS/KS 10K	12	12.8	13	30.5	31	34
	300		JIS/KS 20K	12	12.8	13	30.5	31	34
	600	40	JIS/KS 30K	16	18	19	36	39	44
			100	JIS/KS 40K	16	18	19	36	39

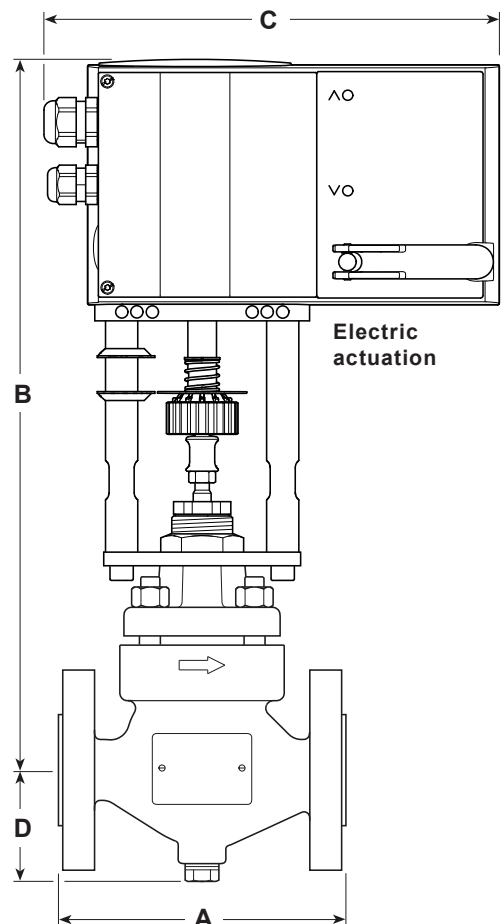
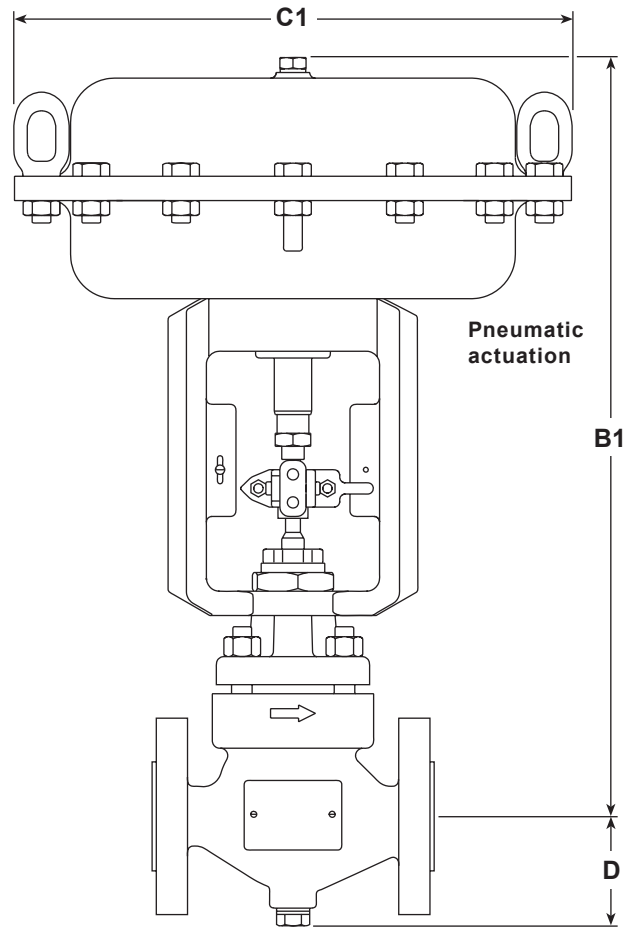

BCV selection guide

Valve size	DN15, DN20, DN25, DN32, DN40 and DN50 ½", ¾", 1", 1¼", 1½" and 2"	DN15
Valve series	BCV	BCV
Body material	4 = Carbon steel 6 = Stainless steel 7 = SG iron 8 = Alloy steel	4
Connections	1 = Screwed - Not available for the BCV8_ 2 = Socket weld - Not available for the BCV7_ 3 = Flanged 4 = Butt weld - Not available for the BCV7_	3
Stem sealing	H = Graphite	H
Seating	W = Stainless Steel 316L with Stellite	W
Type of trim	S = Standard trim	S
Trim-balancing	U = Unbalanced	U
Bonnet type	S = Standard	S
Bolting	S = Standard	S
Flow coefficient	To be specified	Kvs 0.5
Connection type	To be specified	Flanged ASME 300
Actuation	PN = Pneumatic EL = Electrical 230 Vac, 110 Vac or 24 Vac/dc	PN

Selection example

DN15	-	BCV	4	3	H	W	S	U	S	S	-	Kvs 0.5	-	Flanged ASME 300	PN
------	---	-----	---	---	---	---	---	---	---	---	---	---------	---	------------------	----

How to order

Example: 1 off Spirax Sarco DN15 BCV43 pneumatically actuated control valve having flanged ASME 300 connections.

Safety information, installation and maintenance

For full details see the Installation and Maintenance Instructions (IM-P403-103) supplied with the product.

Installation note: The blowdown control valve should preferably be installed with the actuator vertically above the pipework and the flow direction as indicated on the valve body. It can be fitted in other positions, but not upside down.

Disposal: This product is recyclable. No ecological hazard is anticipated with the disposal of the product, providing due care is taken.

Spare parts

The spare parts available are detailed below. No other parts are supplied as spares.

Please note that the spare parts available for the BCV blowdown control valve are the same for both the electrically and pneumatically actuated versions.

Available spares

Actuator clamping nut (Only for high pressure version)		A
Gasket set		B, G
Stem seal kits	Graphite packing	C1
Plug stem and seat kit	Linear trim (No gaskets supplied)	D2, E

How to order spares

Always order spares by using the description given in the column headed 'Available spares', and state the size and type of valve and specify clearly the full product description as found on the label of the blowdown control valve body, as this will ensure that the correct spare parts are supplied.

Example: 1 off Actuator clamping nut for a Spirax Sarco DN15 BCV43 blowdown control valve.

