

M850-W and M850-P Flow Computers Quickstart Guide



M850-W



M850-P

Please note that this is the 'Quickstart Guide' and that all relevant Sections for this product are contained in the main Installation and Maintenance Instructions IM-P333-26.

1. Contents

2. Safety information	5
------------------------------	----------

3. General product and delivery information	9
3.1 Equipment delivery, handling and storage	
3.2 Purpose	10
3.3 Available options	11
3.4 Basic functions	12
3.5 Assistance, service, returns and decommissioning	14

7. Technical information for the M850-W and M850-P	15
---	-----------

8. Mechanical installation	22
8.1 Mounting instructions for the wall mounted B850-W	24
8.2 Mounting instructions for the panel mounted B850-P	28

9. Electrical installation	29
9.1 Important - Please read the following general wiring notes:	
9.2 Important - Please read the following general mains wiring notes	30

10. Commissioning	34
--------------------------	-----------

11. Symbols of failure	45
-------------------------------	-----------

Certain computer programs contained in this product [or device] were developed by Spirax-Sarco Limited ('the Work(s)').

Copyright © Spirax-Sarco Limited 2023

All Rights Reserved

Spirax-Sarco Limited grants the legal user of this product (or device) the right to use the Work(s) solely within the scope of the legitimate operation of the product (or device). No other right is granted under this licence. In particular and without prejudice to the generality of the foregoing, the Work(s) may not be used, sold, licensed, transferred, copied or reproduced in whole or in part or in any manner or form other than as expressly granted here without the prior written consent of Spirax-Sarco Limited.

Manufacturer

Spirax Sarco Limited
Runnings Road
Cheltenham
GL51 9NQ
www.spiraxsarco.com

2. Safety information





Safe operation of this product can only be guaranteed if it is properly installed, commissioned, used and maintained by qualified personnel (see the following sections) in compliance with the operating instructions. General installation and safety instructions for pipeline and plant construction, as well as the proper use of tools and safety equipment must also be complied with.

In the UK, your attention is drawn to IEE Regulations (BS 7671). Elsewhere, other regulations will normally apply. All wiring materials and methods shall comply with relevant EN and IEC standards where applicable. This product must be installed indoors only



Warning

This product is designed and constructed to withstand the forces encountered during normal use. Use of the product other than as a steam flow computer, or failure to install the product in accordance with these instructions, product modifications or repair could:

- Cause damage to the product/property.
- Cause injury or fatality to personnel.
- Invalidate the  and  marks.

Isolate the mains supply before opening the product as hazardous voltages may be exposed.

These instructions must be stored in a safe place near the installation of the steam flow computer at all times.



Warning

This product complies with the requirements of the following directives and harmonized standards:

Low Voltage Directive by meeting the standards of:

- EN 61010-1 Safety requirements for electrical equipment for measurement, control and laboratory use.

Electromagnetic Compatibility Directive by meeting the standards of:

- Immunity EN 61326-1 Table 2
- Radiated and conducted emissions EN 61326-1 Group 1 Class B.

The product may be exposed to interference above the limits of EN 61326 if:

- The product or its wiring is located near a radio transmitter.

Excessive electrical noise occurs on the mains supply. Power line protectors (ac) should be installed if mains supply noise is likely. Protectors can combine filtering, suppression, surge and spike arrestors.
- Cellular telephones and mobile radios may cause interference if used within approximately 1 metre (39") of the product or its wiring. The actual separation distance necessary will vary according to the surroundings of the installation and the power of the transmitter.

2.1 Intended use

- i) Check that the product is suitable for use with the application.
- ii) Determine the correct installation situation.
- iii) Spirax Sarco products are not intended to withstand external stresses that may be induced by any system to which they are fitted. It is the responsibility of the installer to consider these stresses and take adequate precautions to minimise them.

2.2 Access

Ensure safe access and if necessary a safe working platform (suitably guarded) before attempting to work on the product.

2.3 Lighting

Ensure adequate lighting, particularly where detailed or intricate work is required.

2.4 Hazardous environment around the product

Consider: explosion risk areas, lack of oxygen (e.g. tanks, pits), dangerous gases, extremes of temperature, hot surfaces, fire hazard (e.g. during welding), excessive noise, moving machinery.

2.5 The system

Consider the effect on the complete system of the work proposed. Will any proposed action (e.g. closing isolation valves, electrical isolation) put any other part of the system or any personnel at risk?

Dangers might include isolation of vents or protective devices or the rendering ineffective of controls or alarms. Ensure isolation valves are turned on and off in a gradual way to avoid system shocks.

2.6 Tools and consumables

Before starting work ensure that you have suitable tools and / or consumables available.

2.7 Protective clothing

Consider whether you and/or others in the vicinity require any protective clothing to protect against the hazards of, for example, chemicals, high/low temperature, radiation, noise, falling objects, and dangers to eyes and face.

2.8 Permits to work

All work must be carried out or be supervised by a suitably competent person. Installation and operating personnel should be trained in the correct use of the product according to the Installation and Maintenance Instructions. Where a formal 'permit to work' system is in force it must be complied with. Where there is no such system, it is recommended that a responsible person should know what work is going on and, where necessary, arrange to have an assistant whose primary responsibility is safety. Post 'warning notices' if necessary.

2.9 Handling

Manual handling of large and/or heavy products may present a risk of injury. Lifting, pushing, pulling, carrying or supporting a load by bodily force can cause injury particularly to the back. You are advised to assess the risks taking into account the task, the individual, the load and the working environment and use the appropriate handling method depending on the circumstances of the work being done. Arrange suitable lifting gear if required.

2.10 Disposal

The M850 contains a battery. On disposal of the unit or component, appropriate precautions should be taken in accordance with Local/National regulations.

Unless otherwise stated in the Installation and Maintenance Instructions, with the exception of the battery, this product is recyclable and no ecological hazard is anticipated with its disposal providing due care is taken.

2.11 Returning products

Customers and stockists are reminded that under EC Health, Safety and Environment Law, when returning products to Spirax Sarco they must provide information on any hazards and the precautions to be taken due to contamination residues or mechanical damage which may present a health, safety or environmental risk. This information must be provided in writing including Health and Safety data sheets relating to any substances identified as hazardous or potentially hazardous.

The symbols, used on the product, mean:



Equipment protected throughout by double insulation or reinforced insulation.



Functional earth (ground) terminal, to enable the product to function correctly.
Not used to provide electrical safety.



Caution, risk of electric shock.



Caution, risk of danger, refer to accompanying documentation.

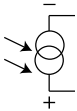

Optically isolated current source or sink.



Caution, Electrostatic Discharge (ESD) sensitive circuit. Do not touch or handle without proper electrostatic discharge precautions.



ac - alternating current



dc - direct current

3. General product and delivery information

The M850 forms part of a flowmetering system and is used with the Spirax Sarco range of flowmeters: Gilflo, ILVA, linear flowmeters and orifice plate assemblies - See Section 4 'System overview' which illustrates the complete system. Depending on the application, it may also be supplied with a differential pressure transmitter, pressure transmitter and/or a temperature transmitter.

These Installation and Maintenance Instructions will enable the rapid connection and commissioning of the flowmetering system.

All the details for this are displayed in a simple and easy to read format.

3.1 Equipment delivery, handling and storage

Factory shipment

Prior to shipment, the Spirax Sarco M850 is tested, calibrated and inspected to ensure proper operation.

Receipt of shipment

Each carton should be inspected at the time of delivery for possible external damage. Any visible damage should be recorded immediately on the carrier's copy of the delivery slip. Each carton should be unpacked carefully and its contents checked for damage:

Content of M850-P

- 1 x Flow computer M850-P
- 2 x Fixing clamps
- 1 x Printed Quickstart Guide
- 1 x USB (Full installation and maintenance instructions, configuration software)
- 1 x Set of terminal blocks
- 1 x Carton package

Content of M850-W

- 1 x Flow computer M850-W
 - 1 x Printed Quickstart Guide
 - 1 x USB (Full installation and maintenance instructions, configuration software)
 - 1 x Carton package
-

If it is found that some items have been damaged or are missing, notify Spirax Sarco immediately and provide full details. In addition, damage must be reported to the carrier with a request for their on-site inspection of the damaged item and its shipping carton.

Storage

If a flow computer is to be stored for a period prior to installation, the environmental storage conditions should be at a temperature between -30 °C and 70 °C (-22 °F and 158 °F), and between 5% and 95% relative humidity (non-condensing).

Before installing and connecting the power ensure there is no condensation within the unit.

3.2 Purpose

M850-P and M850-W devices are microprocessor based, universal flow computers designed for measurement of:

- Flow and heat of steam and water according to IAPWS-IF97,
- Flow and heat of liquids other than water according to characteristics provided by user,
- Flow of technical gases.

M850 flow computers can be used for three different applications of an installation. The flow computers are designated for industrial application in independent measurement applications and as component of computerized measurement and control systems. Implemented math functions enable calculation of flow and energy balances. Extended functions of events and process values recording make it possible to perform analysis of technological processes and alarm conditions. Data recording of process values enables to use this device in places beyond the reach of computer networks. Four output relays provide with signaling and simple control functions. The flow computers are a freely programmable in a broad range and enables configuration of displaying the results depending on user's needs. Comprehensive programming menu allows simple configuration of the instrument.

The device has a panel mount or wall mount construction for indoor industrial applications.

Flow computers can work with the following flowmeters:

- Differential pressure devices ILVA and Gilflo type,
- Differential pressure devices (orifices and nozzles) according to iteration algorithm according to PN EN ISO 5167 standard (only for water and steam),
- Differential pressure devices with approximation by square root curve,
- Volume flowmeters,
- Mass flowmeters.
- Devices are available in six language versions: English, French, German, Spanish, Portuguese or Polish. Language change is available from the device keyboard.

3.3 Available options

Both versions of the M850 series have the same functions and are available as follows:

- **M850-P** for panel mounting and is powered by 24 Vdc.
- **M850-W** for wall mounting and has been adapted to be powered by 100/240 Vac.

Additionally, each version can be optionally equipped with one or two analog outputs 4 - 20 mA.

Available versions

M850	-x	
	-P	Panel mounted version
	-W	Wall mounted version
	-0	Option without analog 4 - 20 mA output
	-1	Option with one analog 4 - 20 mA output
	-2	Option with two analog 4 - 20 mA outputs

3.4 Basic functions

- Measuring channels

The M850 has 12 available inputs; analog, RTD and pulse:

	4 - 20 mA	0 - 20 mA	Pt100	Ni100	PULS*
IN1	+	+			
IN2	+	+			
IN3	+	+			
IN4	+	+			
IN5	+	+			
IN6	+	+			
IN7			+	+	
IN8			+	+	
IN9			+	+	
IN10					+
IN11					+
IN12					+

* **PULS - type inputs** can operate in three modes:

- **State monitoring**, can follow binary signal shorting (closing)/opening; each of the two binary states can be assigned to any analog value (e.g. -1.00/10.0);

Value corresponding to the binary state can be used for simple control or as a value in the math functions (e.g. direction of flow);

- **Frequency measurement** in the range 0.001 Hz ...10 kHz; programmable frequency range allows calibration of the measured value to engineering units (e.g. flow);
- **Pulse counting** should be chosen if a flowmeter with a constant pulse value was connected to the binary input.

Inputs can work with a passive signals (reed-type contact, or OC transistor signals), active voltage signals and the NAMUR standard.

- Math functions and additional measurements

There are 8 channels that can be assigned to an unassigned input as an additional measurement or value calculated from a formula in which can be used measurements value, other calculated values and constant values in the operations of additions, difference, multiplication, division and square root. This allows e.g. to make a balance of flows and energy, the calculation of the average value and the quotient of two values.

- Totalisers

For each measurement inputs, both binary inputs and for each calculated value can be assigned two independent totalisers. Additionally can be attributed totaliser which reset itself every certain period of time (hour/day/month) and totaliser of exceedances triggered after exceeding the preset value.

- Results logging

The results of measurements, calculations and the states of totalisers may be recorded in the device's internal memory with a capacity of 2 GB. The data are stored in text form and secure by encrypted checksum. Additionally can be recorded the events (power interruptions, change of settings, exceedance of alarm and control thresholds, etc.) and authorised activities. The internal memory may contain maximum of 250 files.

- Results displaying

On the front panel there is backlit TFT LCD graphic display and three tri-color LEDs. Depending on the configuration, results of measurements and calculations are presented in digital form (big numbers), analog lines, the table of min/max/average value or in a graph. They can also be displayed collectively in the form of tables that are individually configurable. There is a possibility of sequential displaying screens.

- Keypad - function keys

This device is equipped with seven function buttons. The buttons have changeable functions, depending on the currently displayed information. In addition there is 12-button keypad for numbers and letters entering.

- Relay outputs

Four relays outputs can be assigned to alarm and control thresholds, allow to implement a signalization of exceedance and a simple two-state control. Relays can also be configured to work as pulse outputs. Then a relay is assigned to one of the available totalisers. Number of pulses corresponds to totaliser incrementation. M850-P version has low power solid-state relays, whilst M850-W has electromechanical power relays.

- Current loop outputs 4 - 20 mA (optional)

M850 devices can be equipped with one or two optional analog current loop outputs 4 - 20 mA. These outputs allow to send a signal linearly dependent on any chosen value (measured or calculated). The loop has to be powered by an external voltage source (by connected receiver supply). Current outputs are galvanically isolated from other circuits of the flow computer.

- Communication with a computer system

The unit can be connected to the master computer system by:

- Built-in serial RS-485 port; available is ASCII own protocol and Modbus RTU protocol.
- Ethernet port, available is web server and Modbus TCP protocol.
- In addition, the RS-485 port can be used to connect the GSM module, it enables transfer of information about failures, alarms and measurement values in the form of SMS text messages.

- Report software

Additional software – 850-REPORT, for easier viewing archived results, together with the basic mathematical processing and data selection.

3.5 Assistance, service, returns and decommissioning



3.5.1 For technical assistance

Contact your local Spirax Sarco representative.
Details can be found on order/delivery documentation or on our web site: www.spiraxsarco.com

3.5.2 Service, Maintenance and Cleaning

No special servicing, preventative maintenance or inspection of the product is required.

For cleaning, use a dry cloth. Do not use detergent or water.

3.5.3 Serviceable parts

There are no user serviceable parts, battery is good for the life of the product.

3.5.4 Returning faulty equipment

Please return all items to your local Spirax Sarco representative. Please ensure all items are suitably packed for transit (preferably in the original cartons).

Please provide the following information with any equipment being returned:

1. Your name, company name, address and telephone number, order number and invoice and return delivery address.
2. Description and serial number of equipment being returned.
3. Full description of the fault or repair required.
4. If the equipment is being returned under warranty, please indicate:
 - Date of purchase.
 - Original order number.

3.5.5 Decommissioning

If the product is to be decommissioned please pay full attention to all sections of Section 2 - Safety Information.

7. Technical information M850-W and M850-P

User interface, front panel

Display type	LCD TFT color, 3.5", with LED backlight
Display size/resolution	43.8 mm x 77.4 mm/272 (RGB) x 480 px,
LED indication	3 two-color LEDs, red/green: ALARM, REC, USB
Keyboard	19 membrane buttons

Inputs organisation

Number of inputs	6 x I type (0/4 - 20 mA):	IN1, IN2, IN3, IN4, IN5, IN6
	3 x RTD (4-wire):	IN7, IN8, IN9
	3 x PULS:	IN10, IN11, IN12

I type (0/4 - 20 mA current loop analog inputs)

Signal type	0-20 mA or 4-20 mA
Transmitter connection	2-wire passive transmitter (supplied from M850) or active transmitter (current source transmitter)
Input resistance	95 Ω \pm 10% (protected with PTC 50 mA fuse in series)
Transmitters supply	24 Vdc +10% / -20%; max 22 mA per channel (protected with PTC 50 mA fuse and 100 Ω resistor in series)
A/C converter resolution	18 bit (24 bit Sigma-Delta ADC)
50 Hz/60 Hz filter	Sinc3 digital filter
Damping (1st order Low Pass Software Filter time constant)	2 s/5 s/10 s/20 s/30 s/1 min/2 min/3 min/5 min
Measurement resolution	> 0.01% of FS
Accuracy (at T _{amb} = +25 °C/+77 °F)	\pm 0.1% of FS (typical Ω 0.05% of FS)
Temperature drift	Maximum \pm 0.02% of FS/°C
Maximum input voltage	\pm 40 Vdc/SELV
Galvanic isolation between inputs	No; common potential of functional GND for all inputs
Galvanic isolation to Analog Outputs, RS-485/RS-422, Ethernet	250 Vac continuous; 1500 Vac for 1 minute

M850-W and M850-P Flow Computers

RTD type (3 analog inputs for temperature sensors)

Sensor types	Pt-100 x K; Ni-100 x K; where K = 1..11 (K – multiplier, e.g.: K = 2 for Pt-200)
Measuring range	-200 .. +850 °C / -328 .. +1562 °F for Pt100 x K -60 .. +150 °C / -76 .. +302 °F for Ni100 x K
Sensor connection	4-wire (2-wire with wire bridges)
Wire resistance compensation	Automatic , additional manual in range -99.99 .. +99.99 Ω
Maximum resistance of connecting wires	50 Ω
A/C converter resolution	18 bit (24 bit Sigma-Delta ADC)
50 Hz/60 Hz filter	Sinc3 digital filter
Damping (1 st order Low Pass Filter time constant)	2 s/5 s/10 s/20 s/30 s/1 min/2 min/3 min/5min
Measurement resolution	> 0.05% of reading or 0.1 Ω (TBV)
Accuracy (at T _{amb} = +25 °C/+77 °F)	±0.5 °C/±0.9 °F (typical ±0.3 °C/±0.54 °F)
Temperature drift	Maximum ±0.02 °C / °C / 0.036 °F/°F
Max input voltage	±40 Vdc/SELV
Galvanic isolation between inputs	No; common potential of functional GND for all inputs
Galvanic isolation to Analog Outputs, RS-485/RS-422, Ethernet	250 Vac continuous; 1500 Vac for 1 minute

PULS type inputs (binary/pulse/frequency)

Measuring range	0 .. 20 kHz (cut off for $f < 0.001$ Hz) (0 ..1 kHz with filter jumper J1/J2/J3 ON)
Minimum pulse width	25 μ s (0.5 ms with filter jumper J1/J2/J3 ON)
Accuracy for frequency measurement (at $T_{amb} = +25$ °C/+77 °F)	0.02%
Maximum input voltage	± 40 Vdc/SELV
Galvanic isolation between inputs	No; common potential of functional GND for all inputs
Galvanic isolation to Analog Outputs, RS-485/RS-422, Ethernet	250 Vac continuous; 1500 Vac for 1 minute
Configuration (default): OC or Contact open / closed	(Internal jumper J4/J5/J6 ON)
Open circuit voltage	5 Vdc
Short circuit current	5 mA
On/off threshold	2.7 V/2.4 V
Configuration: Voltage Input	(Internal jumper J4/J5/J6 OFF)
Signal amplitude	4 .. 36 Vdc
On/off threshold	2.7 V/2.4 V
Input resistance	≥ 10 k Ω

Compensated flow and heat energy measurement

Calculation update rate	1 s
Total accuracy of compensated steam, water, other liquid or technical gas flow measurement	Typical: better then $\pm 0.5\%$ (worst case: better then $\pm 2\%$)

4 -20 mA analog output (optional)

Number of outputs	1 or 2
Output signal	4-20 mA passive (external current loop supply required)
Resolution	16 bit DAC
Loop resistance (R_L) range for $U_{CC} = 24\text{ V}$	0 .. 600 Ω
Minimum loop power supply voltage	$U_{CCmin} = R_L \times 0.022 + 8$
Maximum loop power supply voltage	28 Vdc/SELV
Accuracy (at $T_{amb} = +25\text{ }^\circ\text{C}/+77\text{ }^\circ\text{F}$)	Better than $\pm 0.2\%$ of FS/ $^\circ\text{C}$
Temperature drift	Maximum $\pm 0.02\%$ of FS/ $^\circ\text{C}$
Galvanic isolation to Analog Inputs, RS-485/ RS-422, Ethernet	250 Vac continuous; 1500 Vac for 1 minute

Binary outputs (M850-W-x)

Number of outputs	4
Type of outputs	3 pole (COM, NO, NC) electromechanical relay
Contact rating (resistive load)	3 A at 85 .. 250 Vac/30 Vdc
Maximum switching voltage	250 Vac/125 Vdc
Maximum switching power	750 VA/90 W
Over voltage category	CAT III

Binary outputs (M850-P-x)

Number of outputs	4
Type of outputs	2 pole Solid State Relay
Contact rating (resistive load)	0.1 A at 24 Vac/dc (max 42 Vac or 60 Vdc)/SELV
Maximum ON resistance	20 Ω
Galvanic isolation (optoisolation)	250 Vac continuous; 1500 Vac for 1 minute

RS-485/RS-422

Transmission protocol	ASCII, Modbus RTU, BACnet MSTP, GSM
Number of nodes in network	256
Maximum line length	1200 m (depends on quality of data cable and baud rate)
Baud rate	2.4, 4.8, 9.6, 19.2, 38.4, 57.6, 115.2, 230.4 kbps
Parity control	Even, Odd, None
Frame	1 start bit, 8 data bits, parity 1 bit, 1 stop bit
Internal terminating resistor	Yes, activated with DIP switch
Maximum bus terminal voltages	-8 V ... +13 V/SELV
Minimal driver differential output voltage	1.5 V (for $R_L = 54 \Omega$)
Minimum receiver sensitivity	200 mV
Short-circuit/thermal protection	Yes
Galvanic isolation to Analog Inputs, Analog Outputs, Ethernet	250 Vac continuous; 1500 Vac for 1 minute

Ethernet port

Transmission protocol	Modbus TCP, ICMP (ping), DHCP server, http server, BACnet IP
Interface	10 BaseT Ethernet
Data buffer	300 B
Number of opened connections (simultaneously)	4
Connection type	RJ-45/SELV
LED indication	2 (build in RJ-45 socket)

USB port (for flash memory stick only)

Socket type	A type, according to USB standard
Version	USB 2.0
Recording format	FAT16 (within a limited scope)

Power supply (M850-W-x)

Rated supply voltage 100-240 Vac; 50/60 Hz 

Supply voltage range 85 .. 264 Vac; 47 .. 63 Hz 

Power consumption Maximum 20 VA

Over voltage category CAT III

Power supply (M850-P-x)

Rated supply voltage 24 Vdc  (SELV and Limited Energy Supply)

Supply voltage range 18 .. 36 Vdc 

Power consumption Maximum 8 W

Wire terminals (M850-W-x)

Wire connection/terminals Spring type terminal block

Conductor cross section Solid 0.2 .. 2.5 mm²
Stranded 0.2 .. 1.5 mm²
Stranded with ferrule 0.25 .. 1.5 mm²
AWG 26 .. 12

Cable entry 4 glands type M20, 2 glands type M16
4 conduit hubs ½" NPT

Wire terminals (M850-P-x)

Wire connection/terminals Screw type terminal blocks, plug type

Conductor cross section Solid 1.5 mm² max
Stranded 1 mm² max
Stranded with ferrule 0.25 .. 1.5 mm²
AWG 30 / 14

Enclosure (M850-W-x)

Enclosure type Wall mounting, Polycarbonate material

Dimensions (height x width x depth) See Section 8.1
290 mm x 300 mm x 165 mm (in cardboard box)

Weight net (gross) approximate 1.7 kg

Protection class IP65

Enclosure (M850-P-x)

Enclosure type	Panel mounting, Lexan Resin 920 material
Dimensions (height x width x depth)	110 mm x 206 mm x 63.5 mm (without terminals) 110 mm x 206 mm x 72 mm (with terminals) 135 mm x 230 mm x 110 mm (in cardboard box)
Panel cut-out dimensions	186 mm x 92 mm
Panel thickness	1 .. 5 mm
Weight net (gross)	approximate 0.6 kg (0.7 kg)
Protection class (front/rear)	IP65/IP20

Environmental conditions

Ambient temperature	0 .. +55 °C (32 .. 131 °F)
Relative humidity	5 .. 95% (non-condensing)
Altitude	≤ 2000 m (6 562 ft) above sea level
Storage temperature	-30 .. +70 °C
Pollution degree	3 Panel version (when installed in an enclosure) 3 Wall version
Electrical safety	EN 61010-1 CAN/CSA-C22.2 No. 61010-1, 3rd Edition
EMC	Immunity EN 61326-1 Table 2 Radiated and conducted emissions EN61326-1 Group 1 Class B
Installation location	Indoor use only

8. Mechanical installation

Note: Before actioning any installation observe the 'Safety information' in Section 2.

M850

The M850 is available for **wall mounting** M850-W or for **panel mounting** M850-P. **Note:** All versions must be fitted away from sources of excessive heat, electrical interference and from all areas liable to flooding.

Safety note - product specific

This product **must** be installed indoors only, in one of the following ways:

Wall mounting

Fit cable glands/conduit with a minimum IP65 rating or install in a clean dry room to provide a pollution degree 3 environment in accordance with EN 60529 (Specification for degrees of protection provided by enclosures - IP code).

- Any unused cable glands/conduit entries **must** be sealed with an appropriate IP blind grommet.

Panel mounting

The panel mount version of the M850 is supplied with an IP65 rated seal to be fitted between the flow computer and the panel it is to be mounted into.

In addition a blanking panel (Figure 7) is also available to reduce the appearance size if you are replacing an existing M800 with the new M850 (also IP65 rated).



Fig. 7 Blanking panel

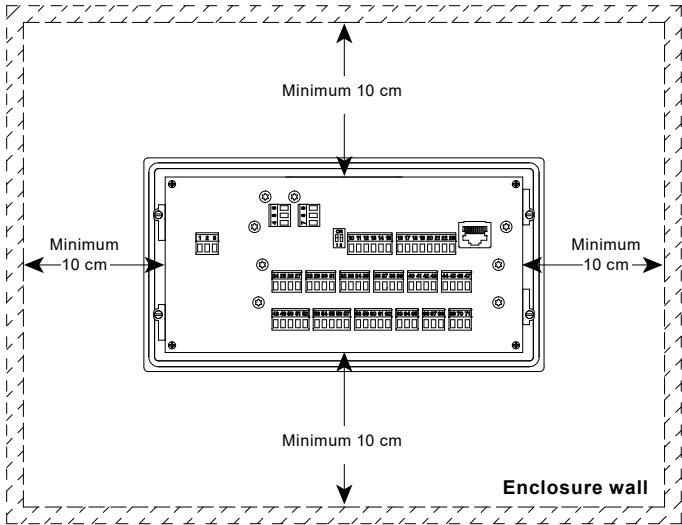

Fig. 8 Panel unit rear view

Environmental conditions

The flow computer should be located in an environment that minimises the effects of heat, vibration, shock and electrical interference.

The flow computer should also be installed away from external magnetic fields, such as those generated from electric motors and large transformers.

Other considerations

Be sure to allow sufficient clearance for:

- Installation of conduit/wiring.
- Viewing of the display.

8.1 Mounting instructions for the wall mounted M850-W:

1. Using the dimensions shown below, drill 3 holes suitable for accepting 5 mm (No.10) screws.
2. Remove the terminals enclosure cover to expose the bottom mounting holes.

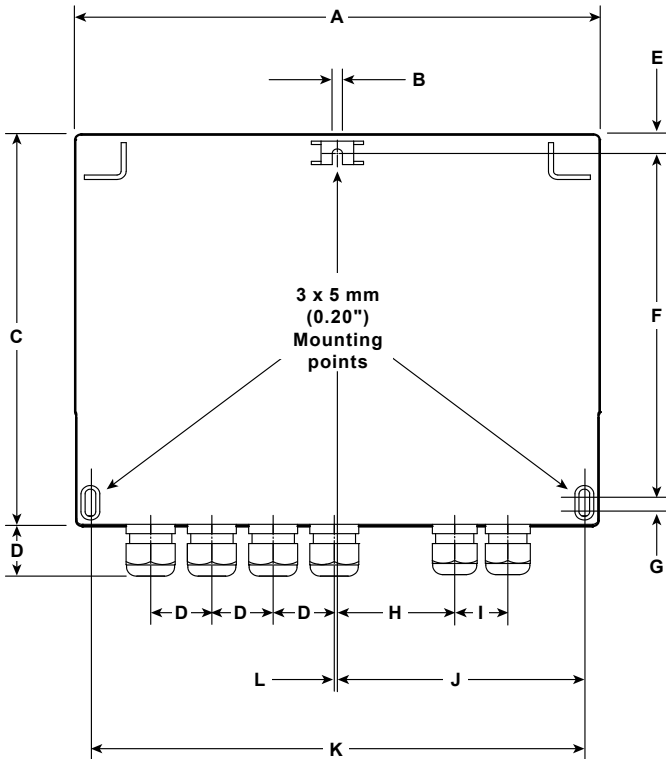

Dimensions (approximate in mm and inches) - M850-W (non cULus version)

A	B	C	D	E	F	G	H	I	J	K	L
257.00 mm	5.00 mm	217.00 mm	30.00 mm	10.60 mm	189.50 mm	10.00 mm	57.50 mm	26.00 mm	121.00 mm	242.00 mm	1.50 mm
10.12"	0.20"	8.54"	1.18"	0.42"	7.46"	0.40"	2.26"	1.02"	4.76"	9.53"	0.06"

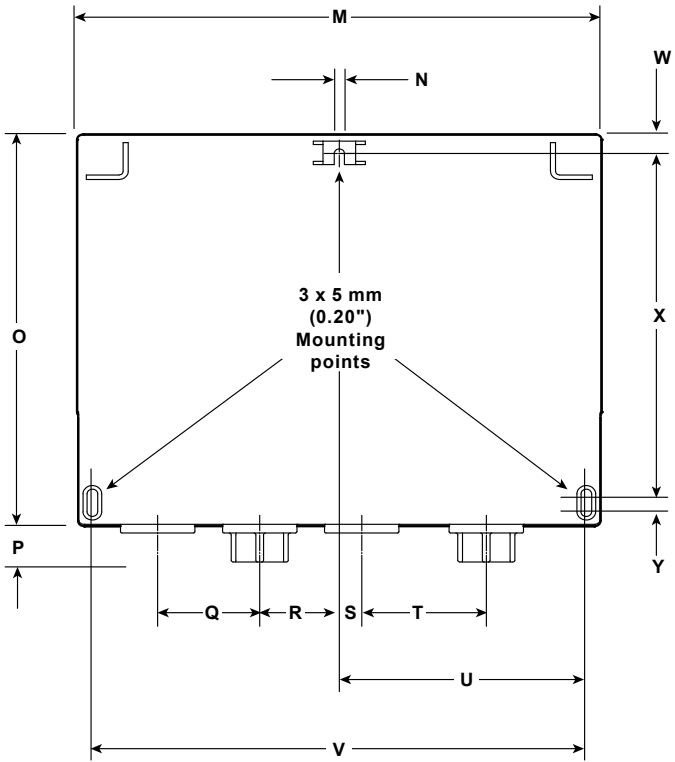

**Dimensions (approximate in mm and inches) -
M850-W (cULus version)**

M	N	O	P	Q	R	S	T	U	V	W	X	Y
257.00 mm	5.00 mm	217.00 mm	21.00 mm	50.00 mm	39.00 mm	11.00 mm	61.00 mm	121.00 mm	242.00 mm	11.00 mm	189.50 mm	10.00 mm
10.12"	0.20"	8.54"	0.83"	1.97"	1.54"	0.43"	2.40"	4.76"	9.53"	0.43"	7.46"	0.39"

M850-W-x



Fig. 9

Bottom mounting eyelet (access through the terminal compartment)

3. Fix an M5 (No.10) screw to the surface for the top mounting. Leave the head of the screw proud of the surface, just enough to allow the top mounting lug of the M850 to slide over.

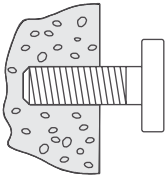

Mounting screw left proud of surface to slot top mounting of M850 over.

4. Slide the top mounting lug over the proud screw.
5. Line up, and fit the screws to the bottom mounting holes.
6. Refit the terminals enclosure cover.

Note: Before actioning any installation observe the 'Safety information' in Section 2.

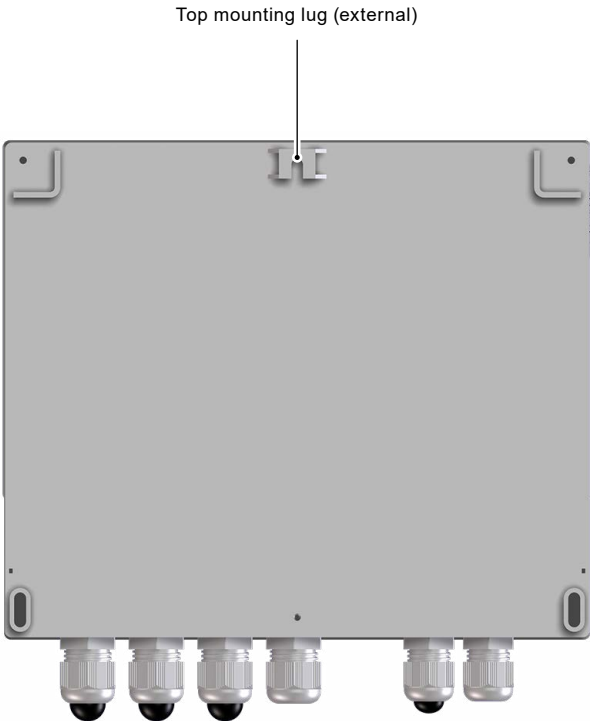
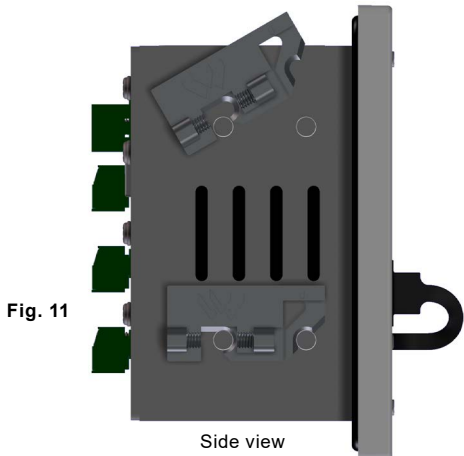

Fig. 10

8.2 Mounting instructions for the panel mounted M850-P:

1. A rectangle aperture 186 mm (7 $\frac{3}{8}$ ") wide x 92 mm (3 $\frac{5}{8}$ ") high is required to mount the panel mounted version of the M850 flow computer.
2. Push the M850 through the aperture ensuring that the seal is fitted correctly.
3. From the reverse side of the panel, using the mounting points on the sides of the M850, assemble the fixing clamps to the body.

Note: Screw clamps removed for clarity



4. Carefully wind in the clamps using the screwdriver slots to tighten the flow computers to the panel.

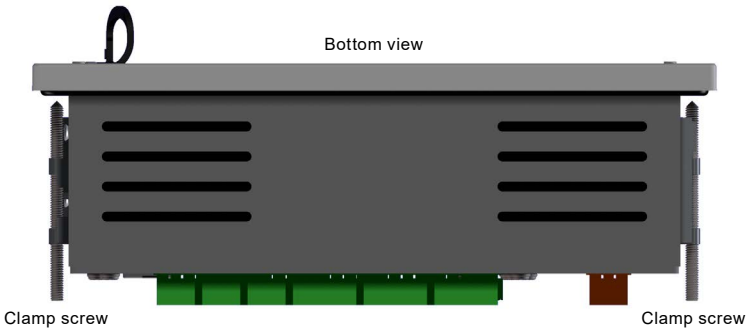

Fig. 12

9. Electrical installation



Note: Before actioning any installation observe the 'Safety information' in Section 2.

9.1 Important - please read the following general wiring notes:

Every effort has been made during the design of the flow computer to ensure the safety of the user but the following precautions must be followed:

1. Maintenance personnel must be suitably qualified in working with equipment containing hazardous live voltages.
2. Ensure correct installation. Safety may be compromised if the installation of the product is not carried out as specified in this manual.
3. Always isolate the flow computer from the mains supply before opening the unit.
4. The design of the flow computer relies on the building installation for overcurrent protection and primary isolation.
5. Overcurrent protection devices rated at 1 amp must be included in all phase conductors of the installation wiring. If overcurrent protection is included in both supply wires then the operation of one must also cause the operation of the other. Refer to IEC 60364 (Electrical Installations of Buildings) or prevalent local standard for full details of requirements for overcurrent protection.
6. Overcurrent protection devices must be fitted to the relay circuit and appropriately rated for the given loads stated in the technical data.
7. Relay contacts must be supplied at the same phase as the product's mains supply.
8. The wall flow computer (M850-W) is designed as an installation category III product.
9. Install wiring in accordance with:



- IEC 60364 - Low-voltage electrical installation.
 - National and Local Electrical Code (NEC) or Canadian code CEC) for the US and Canadian markets. Note; use NEC Class 1 wire with a temperature rating greater than 75 °C. If the cable is to be exposed to a higher temperature, then a higher temperature rating needs to be selected.
10. All external circuits must meet and maintain the requirements of double/reinforced installation as stated in IEC 60364 or equivalent.
 11. Additional protection must be provided to prevent accessible parts (e.g. signal circuits) from becoming Hazardous Live if a wire or screw is accidentally loosened or freed. Ensure all wires are secured to at least one other wire from the same circuit. The attachment must be as close to the terminal block as possible but must not apply undue stress on the connection. Example, use a cable tie to secure the live and neutral wire together. If one wire becomes loose the other wire will prevent it from touching accessible parts.

12. A disconnecting device (switch or circuit breaker) must be included in the building installation. It must:



- Have a rating with sufficient breaking capacity.
- Be in close proximity to the equipment, within easy reach of the operator but not cause difficulty in operating.
- Disconnect all phase conductors.
- Be marked as the disconnecting device for the flow computer.
- Not interrupt a protective earth conductor.
- Not be incorporated into a mains supply cord.
- Comply with the requirements for a disconnecting device specified in IEC 60947-1 (Specification for low-voltage switchgear and controlgear - General rules) and IEC 60947-3 (Switches, disconnectors, switch-disconnectors and fuse-combination units).

13. It is important that the cable screens are connected as shown in order to comply with the electromagnetic compatibility requirements.

9.2 Important - Please read the following general mains wiring notes:

1. The wiring connections are identified on the label inside the terminal cover of the wall mounting version.
2. Fuses should be installed in all live conductors.
3. Double or reinforced insulation must be maintained between:
 - Hazardous live conductors (mains and relays circuits)and
 - Safety extra low voltages (All other components / connectors / conductors).
4. The wiring diagrams show relays and switches in the power off position.

Disconnect device conforming to IEC 60947-1 and IEC 60947-3

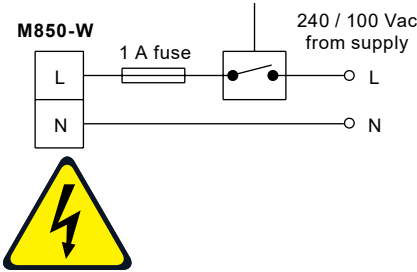

Disconnect device conforming to IEC 60947-1 and IEC 60947-3

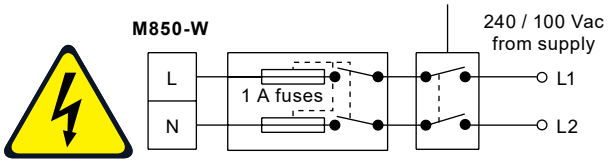

Single phase supply with neutral at earth potential

Mains and signal wiring:

For cable/wire recommendations see IM-P333-26 Flow Computer Installation and Maintenance Instructions.

Screen connection

An earth current loop is created if a wire or screen is connected between two earth points, which are at different potential (voltage). If the instructions are followed correctly, then the screen will only be connected to the earth at one end.

The earth terminal is a functional earth rather than a protective earth.

A protective earth provides protection from electric shock under a single fault condition. This product has double insulation and therefore does not require a protective earth. A functional earth is used in order for the product to operate. In this application, the earth is used as a sink or drain for any electrical interference. The screens must be connected to the earth terminal in order to conform to the EMC directive.

Fig. 13 Wiring diagram – ILVA, Gilflo and Orifice plate systems

Wall mounted M850-W steam flow computer

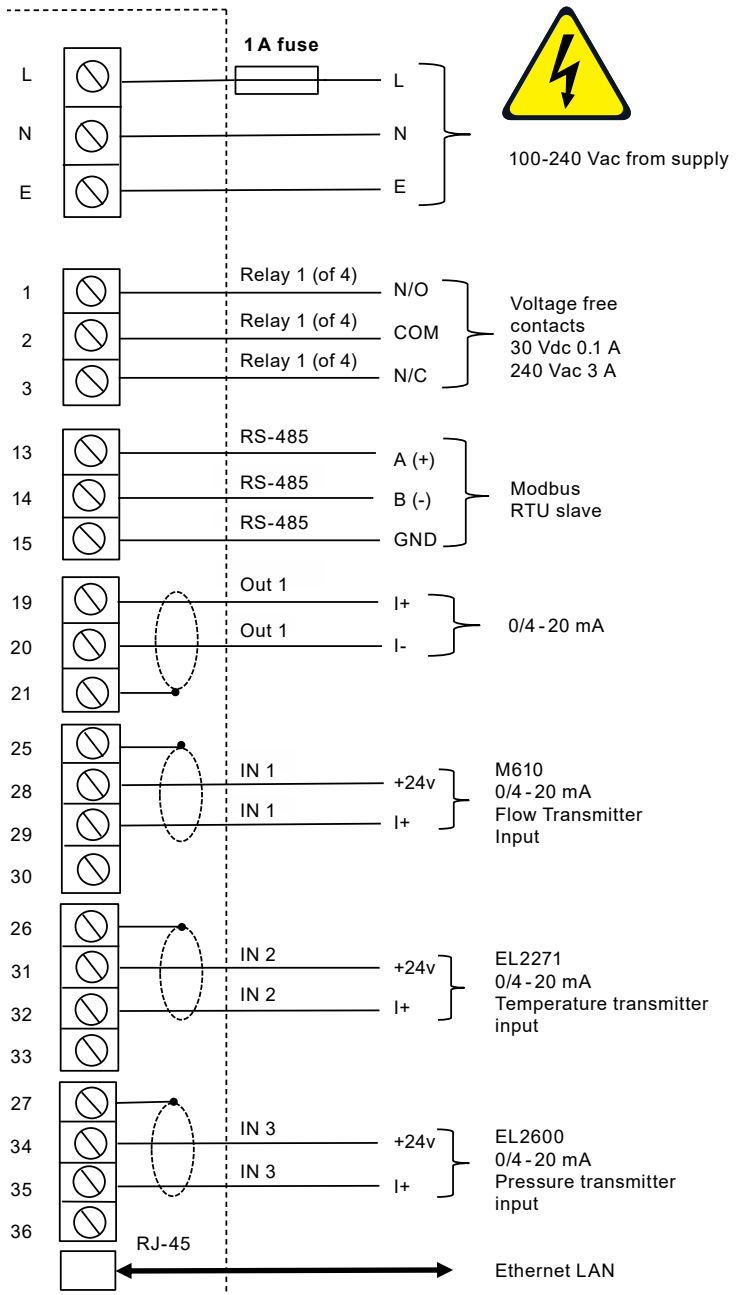

M850-W and M850-P Flow Computers

Fig. 14 Wiring diagram – ILVA, Gilflo and Orifice plate systems

Panel mounted M850-P steam flow computer

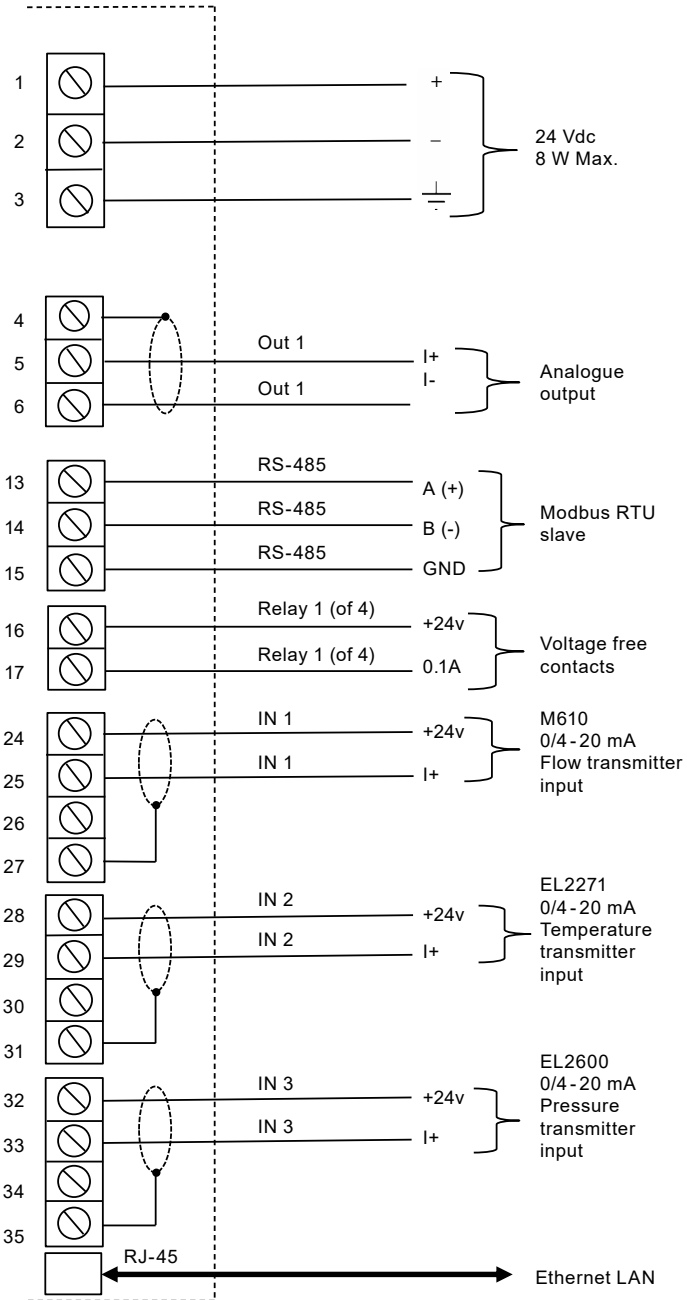

M850-W and M850-P Flow Computers

10. Commissioning

M850 flow computer commissioning using PC software for quick start-up

The M850 flow computer can be commissioned via the key pad on the front panel of the unit itself, or via separate PC software. For quick start commissioning the PC software is used and illustrated in this manual.

The quick start commissioning assumes that the M850 will be used with either Spirax Sarco ILVA, Gilflo or M410 (Orifice plate) flowmeters that all use a differential pressure cell. The quickstart guide will show you how to set up the inputs from the DP Cell and pressure and temperature sensors as a stand-alone system only. To commission other types of flowmeters or additional inputs and outputs please refer to the full installation and maintenance manual (IM-P333-26).

1. Download the commissioning software supplied with the product onto your PC.
2. 'Click' on the icon.
3. Select the language you wish the software to use (English, French, German, Spanish, Portuguese or Polish). 'Click' OK.



4. A grey screen will appear. 'Click' on File/New Settings and select either imperial or metric units.

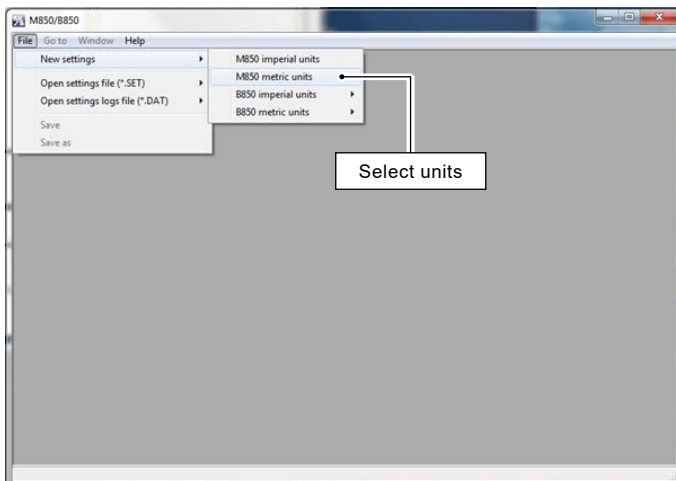

5. Type in a name that you wish to identify the flowmeter into application A, i.e. Boiler house. 'Click' on 'Configure the installation'.

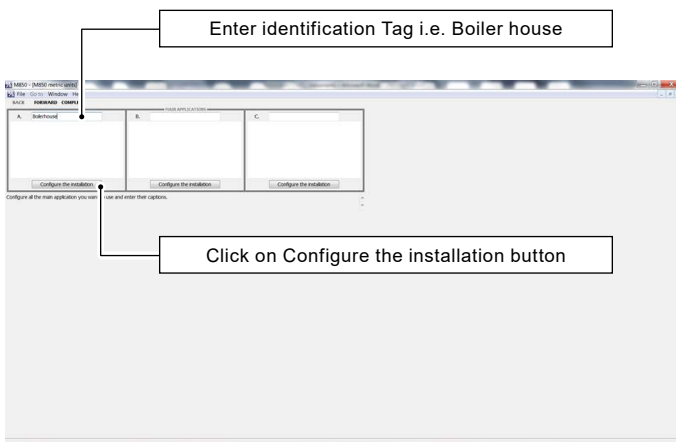

6. Select 'The flow of steam' and 'Next'.

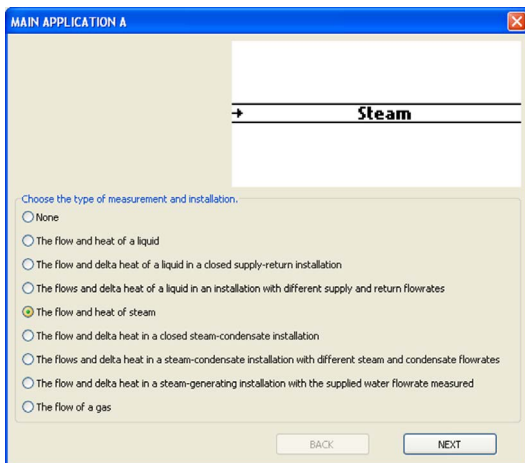

7. Select the option that you require.

To measure saturated steam either a pressure sensor or temperature sensor can be used.

If Superheated steam is being measured both pressure and temperature sensors will be required to calculate density compensation.

We have used pressure for this sample installation.

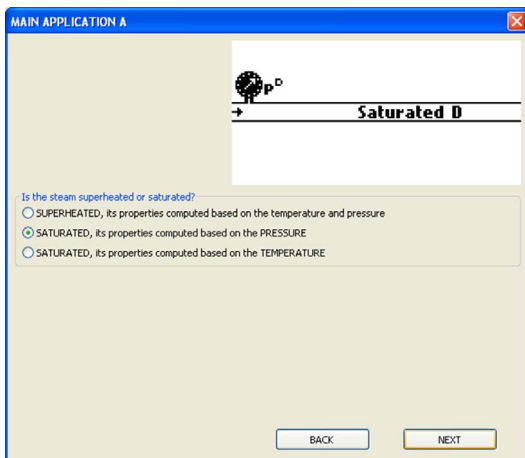

8. Select a differential pressure device and 'Click' on 'Complete'.

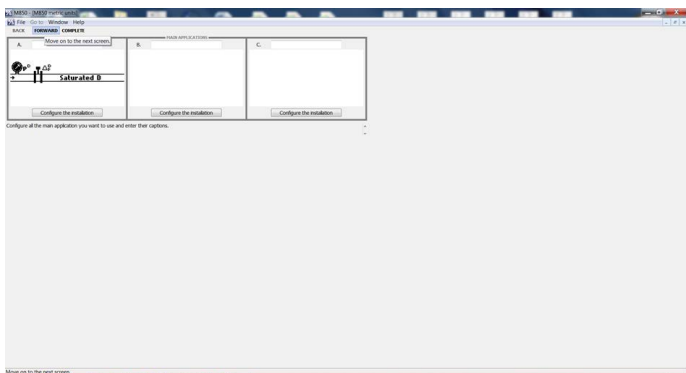
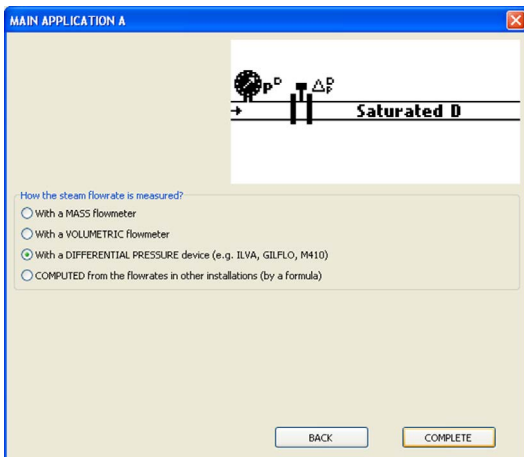

9. Forward through the next two main application screens.
10. Choose the flowmeter type and size you are using from the drop down menu (ILVA, Gilflo or Orifice flange taps (M410)). Enter the MAX F and V-Z coefficients from the flowmeter calibration certificate supplied with the flowmeter (ILVA and Gilflo). Or the information from the Orifice plate tab.

'Click' Forward.

ILVA/Gilflo

Select the flowmeter type and size

Enter Max F and V, W, X, Y, Z coefficients from the flowmeter calibration certificate (ILVA and Gilflo).

Orifice plate (M410)

Enter the values from the orifice plate tab if selected

11. Forward through the next screen (pD computed value).
12. Forward through the next screen (qmD computed value).
13. Forward through the next screen (qvD computed value).
14. At next screen pD measured value (this is your pressure sensor) add a title i.e.: line pressure and assign an input between 2-6.

Change the units to bar g.

Set pressure range to suit sensor i.e. 4 mA = 0 bar g and 20 mA = 10 bar g.

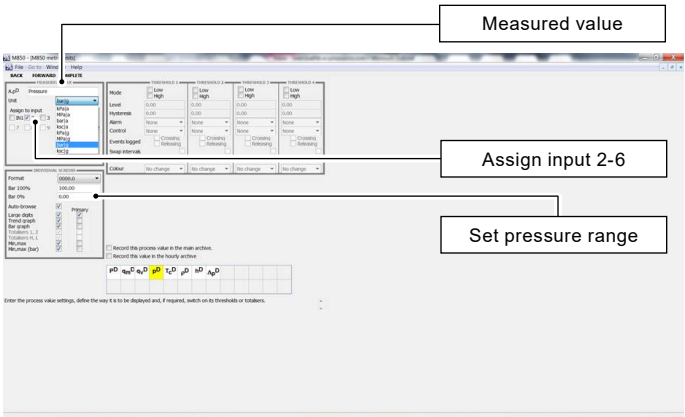

15. Forward through the next screen (TcD computed value).
16. Forward through the next screen (pD computed value).
17. Forward through the next screen (hD computed value).
18. At next screen Pd measured value (this is your DP Cell), add a title i.e. 'Differential Pressure', select mbar units and assign to input 1.
19. Forward through the next screen (Assignment) - **Note:** The pressure range must be set.
20. Forward through the next screen (main archive).

21. At the next screen (main screen for Application A), 'Click' on the 'Mass flowrate' icon.

The button will turn yellow.

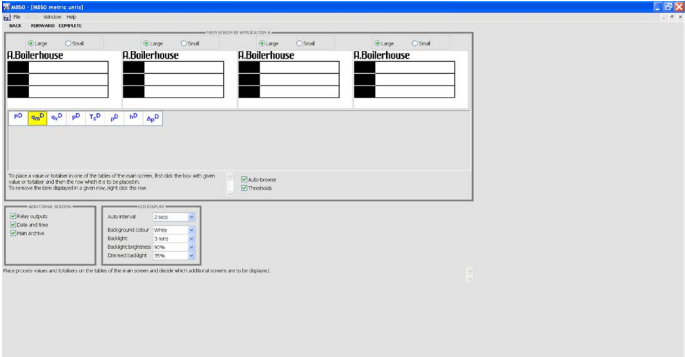

22. 'Click' on the top line of table A. The mass flowrate will show in the table.

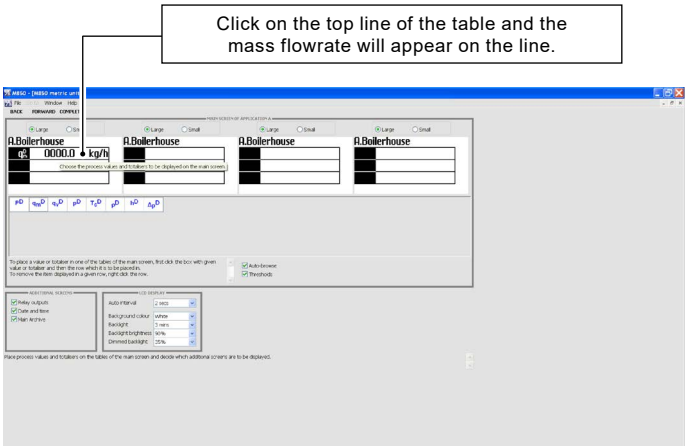

23. Repeat Step 22 for the pressure.

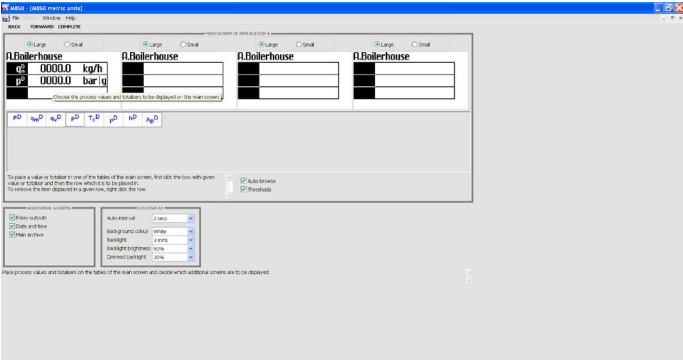

24. Forward through the next screen (4-20 mA outputs).

25. At next screen (media manager) 'Click' on 'Complete'.

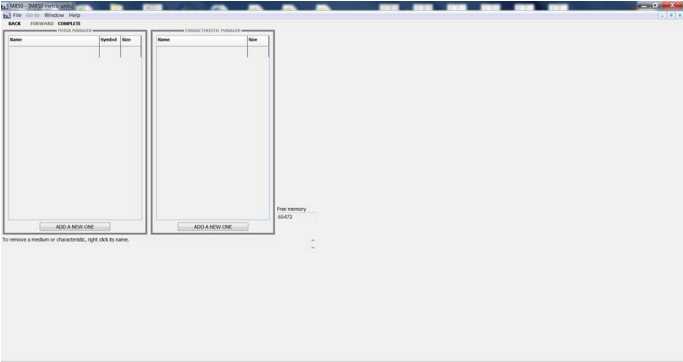

The configuration is now complete.

Save the file to your PC, and copy to a USB stick (memory stick), to enable you to download the file to the M850 flow computer.

Quickstart commissioning flowchart

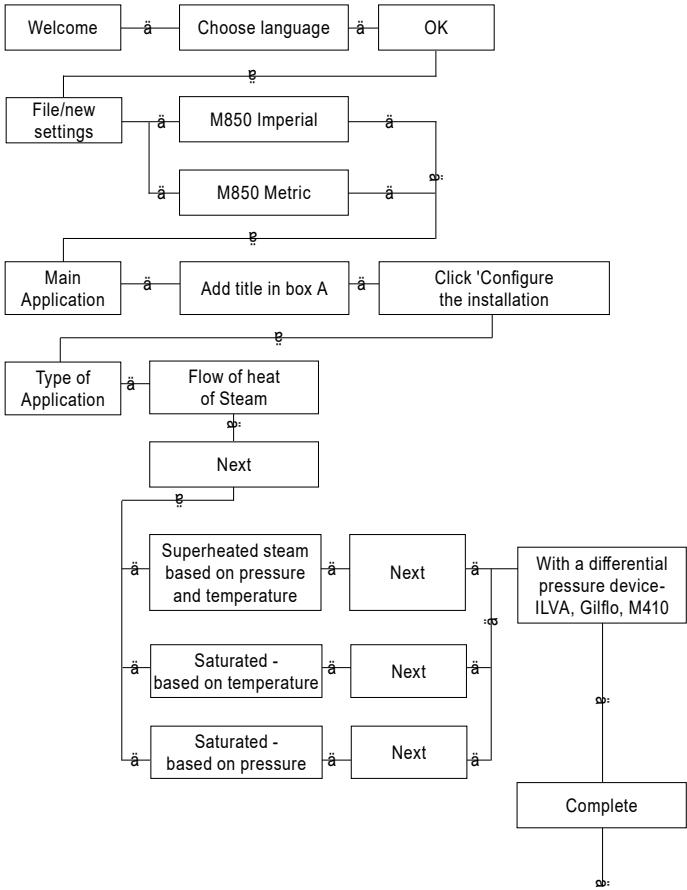

Continued on next page

Continued from previous page

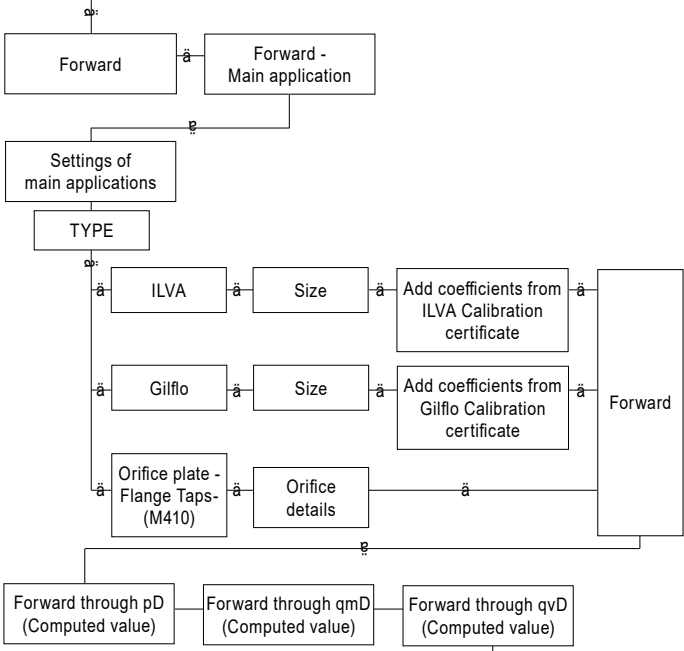

Depending on which application has been chosen, this part may differ from the illustration.
 Measuring saturated steam based on pressure will only show pD.
 Measuring saturated steam based on temperature will only show tD.
 Measuring superheated steam will show both pD and tD as illustrated.

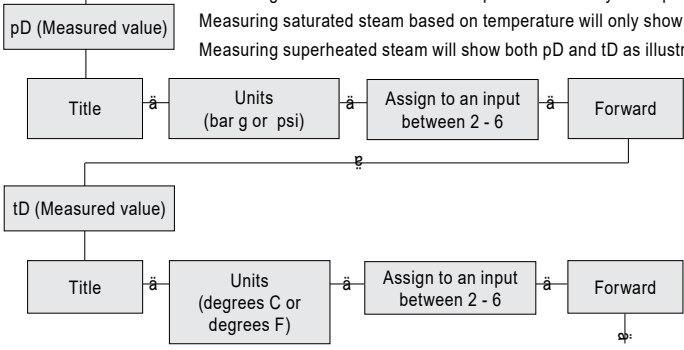

Continued on next page

Continued from previous page

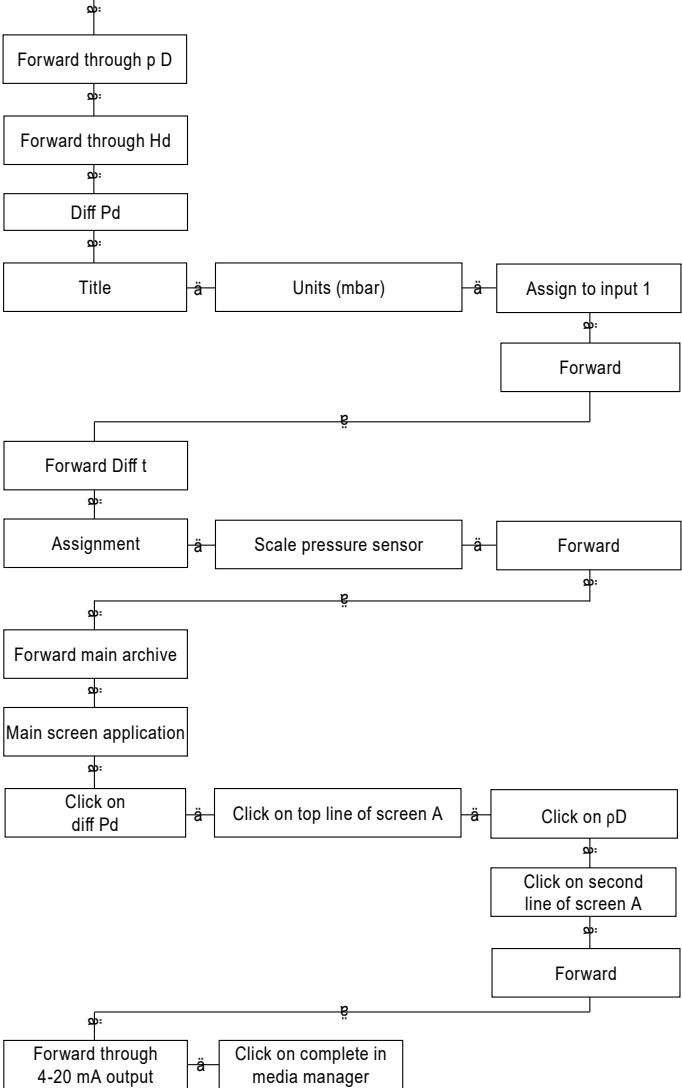

11. Symbols of failure

Failure notification of measurement inputs

Failures associated with particular channels are marked with appropriate symbols on the display.

Symbols of failure:

-F-	RTD sensor failure
- -	4-20 mA transducer failure, current below 3.6 mA
-E-	4-20 mA transducer failure, current above 22 mA
-S-	steam parameters below saturation curve (only when detection of steam saturation is on)
-R-	exceeding the range
-W-	wait (after power on, when data is not ready)
-C-	internal communication error

Symbols of failure are displayed instead of the result for all related channels, e.g. for measurement input and the calculation channel in which the result is used.

No signal from the sensor assigned to the particular input is treated as a failure and marked on the display with the '-F' (failure) symbol. Detection of a failure may trigger displaying the appropriate message and then require confirmation by the user even if the cause of the failure ended earlier. Depending on the settings during programming the device, a failure may cause the excitation of corresponding output relay till the confirmation or for the entire duration of failure. Failure and its disappearance may be recorded in the Event log.

If a GSM module is connected to the RS-485 port, failure information can be sent via text message to specified phone numbers.

