

LP10-4

Level Probe

Installation and Maintenance Instructions

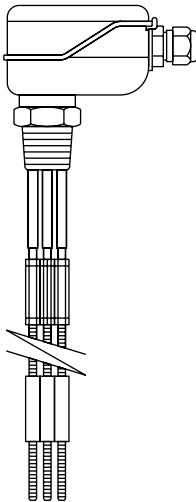

1. Safety information
2. General product information
3. Installation
4. Wiring
5. Maintenance

1. Safety information

Your attention is drawn to any National or local regulations.

The product is designed and constructed to withstand the forces encountered during normal use. Use of the product for any other purpose, or failure to install the product in accordance with these Installation and Maintenance Instructions, could cause damage to the product and may cause injury or fatality to personnel.

Pressure equipment not bearing the CE mark is classified 'Sound Engineering Practice' in accordance with Article 3, Paragraph 3 of the Pressure Equipment Directive 97/23/EC.

Note: By law, SEP products cannot be marked with the CE symbol.

Warning

If this product is not used in the manner specified by this IMI, then the protection provided may be impaired.

1.1 Intended use

- i) Check that the product is suitable for use with the intended fluid.
- ii) Check material suitability, pressure and temperature and their maximum and minimum values. If the maximum operating limits of the product are lower than those of the system in which it is being fitted, or if malfunction of the product could result in a dangerous overpressure or overtemperature occurrence, ensure a safety device is included in the system to prevent such over-limit situations.
- iii) Determine the correct installation situation and direction of fluid flow.
- iv) Spirax Sarco products are not intended to withstand external stresses that may be induced by any system to which they are fitted. It is the responsibility of the installer to consider these stresses and take adequate precautions to minimise them.
- v) Remove protection covers from all connections and protective film from all name-plates, where appropriate, before installation on steam or other high temperature applications.

Safe operation of these products can only be guaranteed if they are properly installed, commissioned, used and maintained by qualified personnel (see Section 1.11) in compliance with the operating instructions. General installation and safety instructions for pipeline and plant construction, as well as the proper use of tools and safety equipment must also be complied with.

1.2 Access

Ensure safe access and if necessary a safe working platform (suitably guarded) before attempting to work on the product. Arrange suitable lifting gear if required.

1.3 Lighting

Ensure adequate lighting, particularly where detailed or intricate work is required.

1.4 Hazardous liquids or gases in the pipeline

Consider what is in the pipeline or what may have been in the pipeline at some previous time. Consider: flammable materials, substances hazardous to health, extremes of temperature.

1.5 Hazardous environment around the product

Consider: explosion risk areas, lack of oxygen (e.g. tanks, pits), dangerous gases, extremes of temperature, hot surfaces, fire hazard (e.g. during welding), excessive noise, moving machinery.

1.6 The system

Consider the effect on the complete system of the work proposed. Will any proposed action (e.g. closing isolation valves, electrical isolation) put any other part of the system or any personnel at risk?

Dangers might include isolation of vents or protective devices or the rendering ineffective of controls or alarms. Ensure isolation valves are turned on and off in a gradual way to avoid system shocks.

1.7 Pressure systems

Ensure that any pressure is isolated and safely vented to atmospheric pressure. Consider double isolation (double block and bleed) and the locking or labelling of closed valves. Do not assume that the system has depressurised even when the pressure gauge indicates zero.

1.8 Temperature

Allow time for temperature to normalise after isolation to avoid danger of burns.

1.9 Tools and consumables

Before starting work ensure that you have suitable tools and/or consumables available. Use only genuine Spirax Sarco replacement parts.

1.10 Protective clothing

Consider whether you and/or others in the vicinity require any protective clothing to protect against the hazards of, for example, chemicals, high/low temperature, radiation, noise, falling objects, and dangers to eyes and face.

1.11 Permits to work

All work must be carried out or be supervised by a suitably competent person. Installation and operating personnel should be trained in the correct use of the product according to the Installation and Maintenance Instructions.

Where a formal 'permit to work' system is in force it must be complied with. Where there is no such system, it is recommended that a responsible person should know what work is going on and, where necessary, arrange to have an assistant whose primary responsibility is safety.

Post 'warning notices' if necessary.

1.12 Handling

Manual handling of large and/or heavy products may present a risk of injury. Lifting, pushing, pulling, carrying or supporting a load by bodily force can cause injury particularly to the back. You are advised to assess the risks taking into account the task, the individual, the load and the working environment and use the appropriate handling method depending on the circumstances of the work being done.

1.13 Residual hazards

In normal use the external surface of the product may be very hot.

Many products are not self-draining. Take due care when dismantling or removing the product from an installation.

1.14 Freezing

Provision must be made to protect products which are not self-draining against frost damage in environments where they may be exposed to temperatures below freezing point.

1.15 Safety information - Product specific for level control and level limiting/alarm products in steam boilers

Products/systems must be selected, installed, operated, and tested in accordance with:

- Local or National standards and regulations.
- Guidance Notes, (Health and Safety Executive BG01 and INDG436 in the UK).
- The requirements of Approvals Authorities.
- Boiler Insurance Bodies.
- Boiler manufacturer's specifications.

Two independent low water limiting/alarm systems must be installed on steam boilers. Level probes must be installed in separate protection tubes/chambers, with sufficient clearance between the tips, and earth.

Each probe must be connected to an independent controller. The alarm relays must isolate the boiler heat supply at low alarm status.

A high water alarm may be part of the water level control, or a separate system. An independent high water alarm system must be fitted if it is considered a safety requirement. In this case, the relays must simultaneously isolate the feedwater supply and the boiler heat supply at high alarm status. All boiler water limiters/alarms require regular functional testing.

A suitable water treatment regime must be used to ensure continuous safe and correct operation of the control and limiter systems. Consult the above authorities and a competent water treatment company.

1.16 Disposal

Unless otherwise stated in the Installation and Maintenance Instructions, this product is recyclable and no ecological hazard is anticipated with its disposal providing due care is taken.

1.17 Returning products

Customers and stockists are reminded that under EC Health, Safety and Environment Law, when returning products to Spirax Sarco they must provide information on any hazards and the precautions to be taken due to contamination residues or mechanical damage which may present a health, safety or environmental risk. This information must be provided in writing including Health and Safety data sheets relating to any substances identified as hazardous or potentially hazardous.

— 2. General product information —

2.1 Description

The Spirax Sarco LP10-4 level probe is designed for use with a Spirax Sarco LC1300 or LC1350 controller to provide on/off level control and alarm functions in steam boilers, tanks, or other vessels. The probe is also suitable for use with a wide range of conductive liquids.

2.2 Pressure/temperature limits

| | | | |
|-------------------------|--------------|----------|-------------|
| Nominal pressure rating | | | PN40 |
| Maximum pressure | Standard | 32 bar g | (464 psi g) |
| | UL certified | 30 bar g | (435 psi g) |
| Maximum temperature | Standard | 239°C | (462°F) |
| | UL certified | 235°C | (455°F) |
| Ambient temperature | Maximum | 70°C | (158°F) |
| | Minimum | -20°C | (-4°F) |

2.3 Technical data

| | | | |
|--|---------|---------------------|---------|
| Pollution degree | | | 3 |
| Maximum cable length (probe to controller) | | 30 m | (98 ft) |
| Sensing depth | Maximum | 2095 mm | (82.5") |
| | Minimum | 75 mm | (3") |
| Minimum conductivity (when used with an LC1300 level controller) | | 1 μ S/cm @ 25°C | (77°F) |

2.4 How the LP10-4 level probe works

The LP10-4 has four detachable tips which are cut to length on installation to give the required switching levels. The probe body is earthed through its 1" screwed connection, and the boiler or tank normally forms the earth return path. If the probe is to be used in a non-conductive tank, (concrete or plastic, for example), use one of the tips as an earth return, or provide a separate earthing rod or plate.

When a tip is immersed in a conductive liquid it completes an electrical circuit to earth. When the level drops below the tip, the resistance to earth becomes high, signalling to the controller that the tip is out of the liquid.

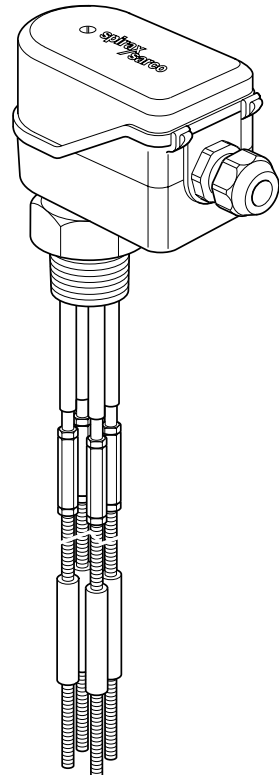

Fig. 1

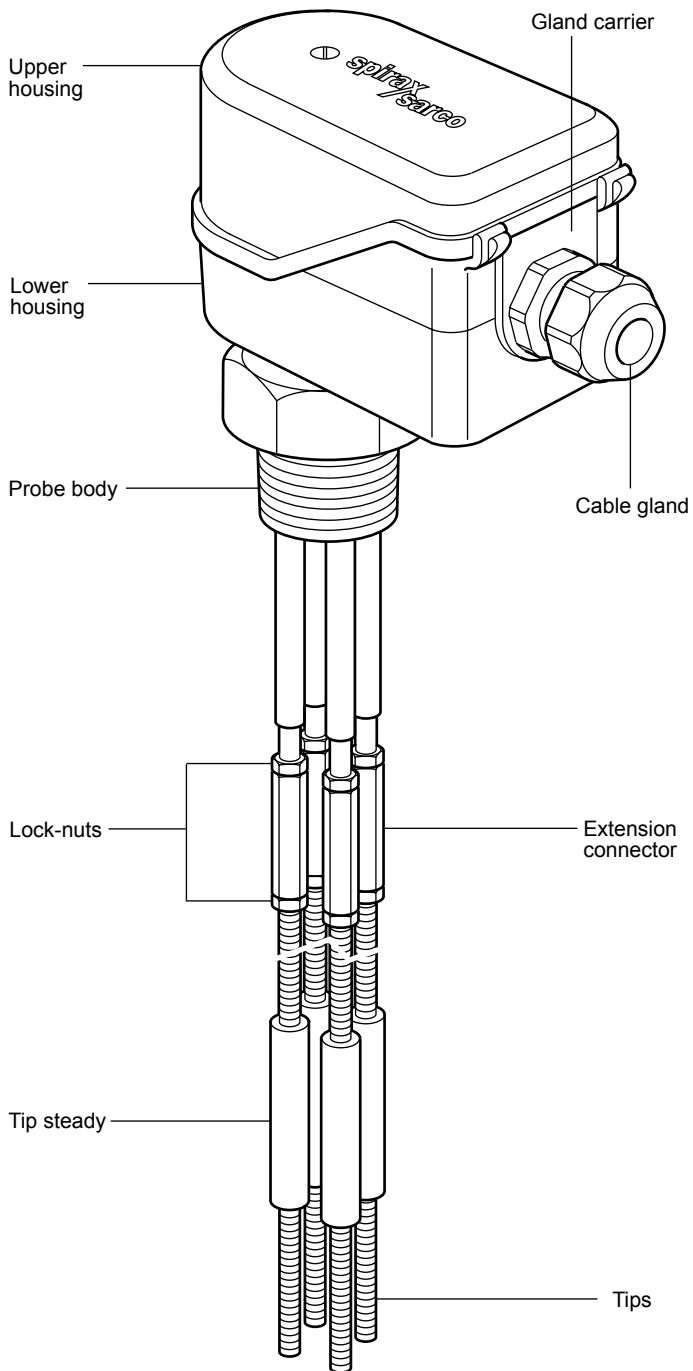

Fig. 2

3. Installation

3.1 General

For steam boiler applications, the probe may be installed in an external chamber or inside the boiler. A protection tube must be used for boiler shell installations, and suitable designs are shown in separate literature.

WARNING

Though two probes may be installed in one protection tube, where two low water level alarms are required in a boiler, these must be completely independent. Separate probes, in separate protection tubes or chambers, and separate controllers must be used.

Wherever possible the boiler manufacturer should be consulted for advice on the working and alarm water levels.

WARNING

Under certain circumstances the water level inside a boiler can be different to that shown in the gauge glass. Separate literature on this subject is available from Spirax Sarco.

Do not install the probe outdoors without additional weather protection. The probe is designed for installation in a 1" BSP parallel (Rp1), or 1" NPT threaded flange. These threads should always be specified for new installations.

The tip steady provides lateral support as well as insulating the tips from each other.

The switching levels are at the extreme end of the probe tips, which are cut to length to give the required alarm or pump signals to the controller.

Probe tips are supplied in sets of four, 1 000 mm (3.28 ft) long, complete with coupling pieces, lock-nuts, and two steadies. Two tip assemblies may be joined together if necessary to give a maximum total tip length of 2 095 mm (6.87 ft).

WARNING

The tip steady is an essential part of the probe and must be fitted. Failure to fit the tip steady may lead to short-circuits between the tips, or by the tips touching the protection tube - a potentially hazardous situation.

3.2 Installation procedure

CAUTION: To avoid bending or twisting the probe tips, it is important to support the probe along its length when handling, particularly if the probe is over 1 m (39") long. Do not allow the probe tips to rotate in the probe body when tightening the connectors or lock-nuts.

- Fit the four tips to the probe using the extension connectors and lock-nuts provided.
- Ensure that the extension connectors are threaded fully onto the probe tips.
- Tighten the lock-nuts.
- Align the probe tips, and make sure they are more or less the same length, so that all tips will fit into a tip steady.
- Place a tip steady over the end of the tips.
- Using the plastic cap from the packaging or other suitable protector, smartly tap the steady onto the probe tips with the flat of the hand. Once started in this way, the tip steady can be temporarily positioned quite easily by sliding it down the tips.
- Fit the second tip steady in the same manner (see Figure 3).
- If used, fit the second set of extension connectors, probe tips, and two more steadies in the same way (see Figure 4).
- Tighten the connector lock-nuts.

WARNING

Failure to tighten the connector lock-nuts fully may lead to tips becoming loose or falling off.

- Ensure the water is at the first required level. This could, for example, be the low alarm level. (Typically, levels sensed by a four tip probe might be high alarm, pump off, pump on, and low alarm).
- Mark a metal rod with a water-soluble felt pen, and dip the boiler to find the depth from the top of the probe mounting flange to the water level. Alternatively, take the level from a gauge glass.
- Transfer this level to the probe tip, and measuring from the underside of the probe body, mark the position of the proposed cut (nick with a file or hacksaw) on the probe tip, **15 mm (0.6") less than the dipped length** - double check before cutting the probe to length. See Figure 3.
- Repeat this procedure for the other tips.
The probe tips are identified by coloured sleeves.

| | | | | | |
|--------------|-------|---------------|-------|--------------|-------|
| Brown | Tip 1 | Orange | Tip 3 | Black | Earth |
| Red | Tip 2 | Yellow | Tip 4 | | |

Position the lowest tip steady(ies), above the water level if possible. The steady should support all probe tips, and be at least 15 mm (0.6") away from the end of the shortest tip(s). The maximum length for an unsupported tip is 250 mm (9.8"). The minimum tip length is 75 mm (3") (no extension connector fitted). See Figure 3.

If a probe steady is fitted to less than all four probe tips, cut off the unused section of the tip steady to avoid it catching on the probe mounting flange when removing the probe for maintenance. See Figure 4.

3.3 Install the probe as follows:

- Ensure both male and female threads (1" BSP taper / 1" NPT, 41 A/F) are in good condition.
- Use up to three turns (no more) of PTFE thread sealing tape on the probe thread.
WARNING: Do not use excessive tape. Do not use paste type jointing compound.
- Fit and tighten the probe by hand initially. Use a suitable spanner to tighten the probe. Under no circumstances use a pipe wrench.
- Due to the nature of a taper/parallel joint it is not possible to recommend tightening torque figures.
- Do not overtighten. There should always be visible thread on the probe.
- **Note:** The probe thread will not 'bottom out' (i.e. probe body hexagon contacts the face of the female screwed connection), unless there is excessive wear or an out-of-tolerance female thread, in which case it will be necessary to replace or re-work the flange or connection.

3.4 Subsequent removal and refitting

WARNING: Ensure boiler or vessel is depressurised and vented to atmosphere before attempting to unscrew or remove the probe:

- Always use correct size spanner, not a pipe wrench.
- Inspect male and female threads for signs of damage, which may have occurred through overtightening, leading to torn threads or even localised cold welding (galling / picking up).
- If damage has occurred, replace the probe.

Fig. 3
Standard installation (for probes up to 1 000 mm (39"). For installations up to 2 095 mm (6.87 ft), see Fig. 4.

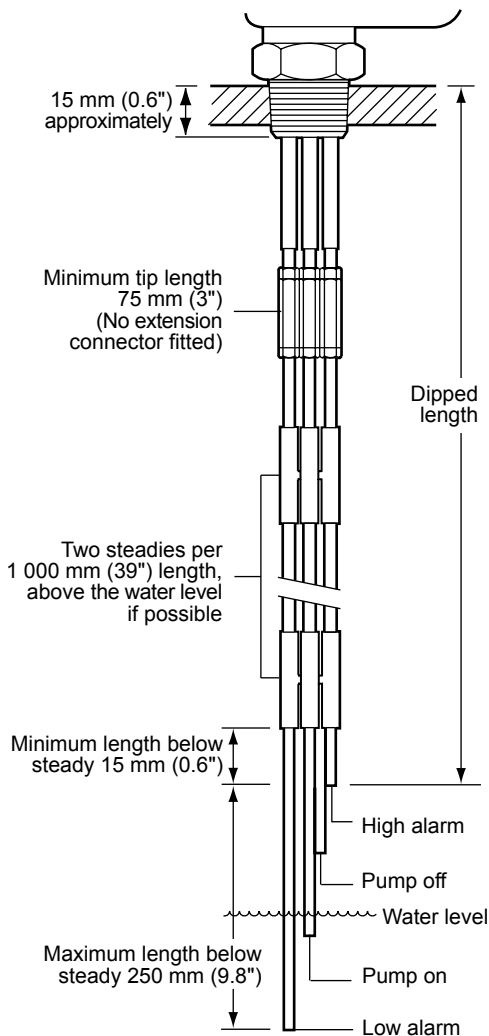
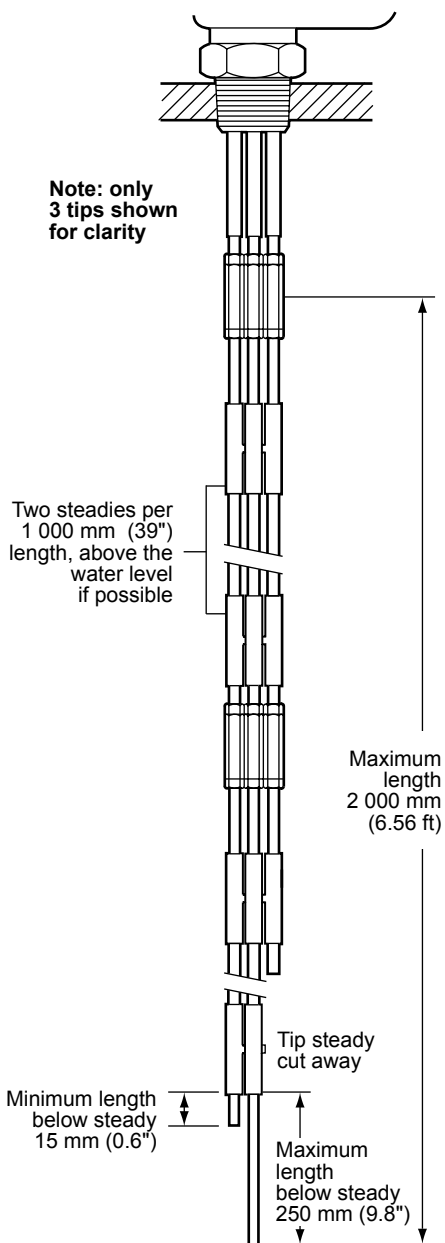

Fig. 4
Installation for 1 000 mm to 2 000 mm (39" to 6.56 ft) depth, extended using second probe tip, extension connectors and steady.



4. Wiring

4.1 General information

Cabling should be installed in accordance with BS 6739 - Instrumentation in Process Control Systems: Installation design and practice or local equivalent.

4.2 Cable specification - Note that the cable must be screened

Use 5-core (or 4-core and earth) 1 mm² (18 - 16 AWG), high temperature cable. This may be solid or stranded, with a maximum length of 30 m (98 ft) for the LC1300. Pirelli FP200 or Delta Crompton Firetuf OHLS are two suitable types for the standard probe.

4.3 Connection

Remove the upper housing screw to gain access to the wiring terminals.

The LP104 is supplied with four crimp terminals for connection to the probe tips. An un-insulated crimp ring terminal is supplied for the probe body earth connection. It can be fitted to either of the two M3 female threads, (see Figure 5).

An additional screw and crimps are provided, together with coloured sleeves for easy identification of wiring. A connector set is available as a spare from Spirax Sarco, Stock No. 4024480.

Caution: - Do not use standard crimps – the ones supplied are a special high temperature type.

Use a dual-purpose crimp tool (for insulated and un-insulated crimps) to make the connections, e.g. RS Components 534-806 or Farnell 210-511.

A M20 cable gland is provided for cable with an overall diameter of 5 mm - 12 mm. The probe can be connected to Pg16, ½" BSP, ½" NPT or M20 threaded flexible conduit by removing the gland and fitting a back nut (an M20 back nut is supplied with the product).

Do not install low voltage cables near high voltage cables or switchgear, as this may reduce the performance of, or cause damage to the product. Probe cables must not use the same conduit/wiring trays as power cables or other wiring.

Ensure internal wires and crimp terminals have not been stressed or damaged during installation. Remove upper housing and check wiring before commissioning the system.

The wiring loom may be disconnected and removed from the LP10-4 probe without disturbing the cable gland:-

- Remove the upper housing and lift the gland carrier, complete with wiring, out of the lower housing. Ensure that sufficient cable or flexible conduit length is provided and to ensure that no strain is placed on the unit.
- Do not over-tighten upper housing screw.

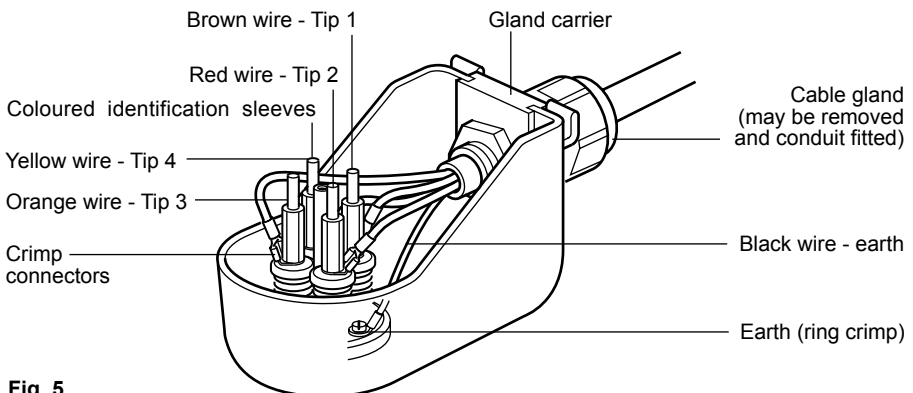

Fig. 5

4.4 Screen connection

An earth current loop is created if a wire or screen is connected between two earth points that are at different potential (voltage). If the instructions are followed correctly, then the probe cable screen will only be connected to earth at one end.

Note. The probe earth terminal is a functional earth rather than a protective earth.

A **protective earth** provides protection from electric shock under a single fault condition. This product is protected by double insulation and therefore does not require a protective earth.

A **functional earth** is used in order for the product to operate. In this application, the earth (boiler shell) is used as the common of the probe. It also provides a sink/drain for any electrical interference.

- Ensure that the screen is connected to earth terminal of the probe and to the common terminal of the controller.
- Ensure the common terminal of the controller is not internally earthed (all Spirax Sarco boiler controls are internally isolated from earth).
- The common terminal of the controller must only be earthed via the probe.

Caution:

Do not connect the common terminal to an earth local to the controller.

To do so may induce an earth current loop, which may reduce the performance or damage the product.

4.5 Wiring diagram

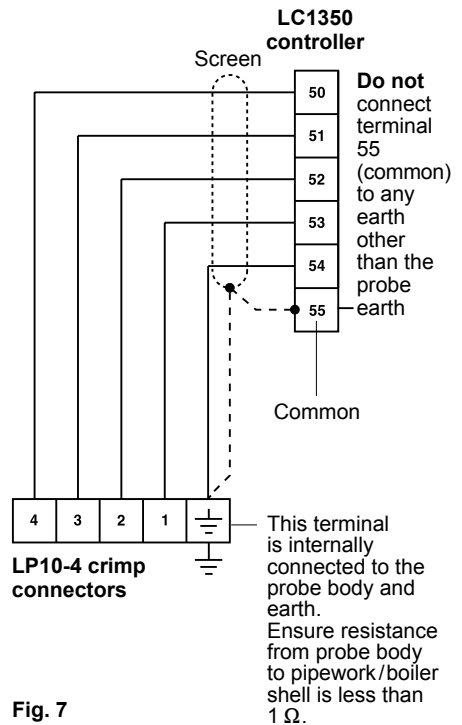
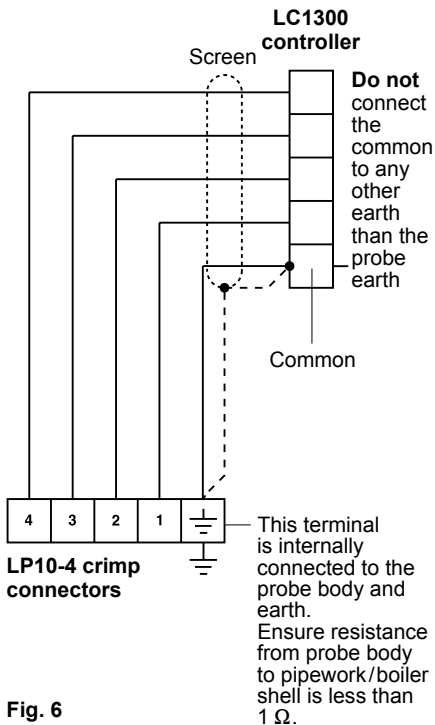

5. Maintenance

Probe body cleaning instructions - Use a cloth dampened with tap / de-ionised water or isopropyl alcohol. Use of other cleaning materials could damage the product and invalidate the warranty.

Frequent maintenance of the probe should not be necessary. However steam boiler water level controls do require regular testing in accordance with National and Regional regulations, and in the UK, Guidance Notes published by the Health and Safety Executive.

The UK Health and Safety Executive recommends that boiler controls should be inspected at least at quarterly intervals. We recommend that this frequency is also followed outside the UK unless National or Regional regulations state otherwise.

Where regular tests are carried out properly in a well run boiler house with good water treatment, it may be that only an annual inspection of the probe is required.

This is a matter, however, for the user to decide in liaison with the boiler inspector in order to determine a sensible inspection programme to suit the individual boiler plant.

We recommend that the inspection is carried out as follows:

- Depressurise and vent boiler/vessel, - observe safety precautions.
- Disconnect the electrical supply to controller.
- Remove probe upper housing and inspect for dirt or moisture.
- Disconnect wiring and remove probe.
- Clean housing if necessary.
- Check condition of probe.
- Clean probe tips and insulation if necessary with a cloth or soft bristle brush - **do not** use abrasive or conductive products such as steel wool.

WARNING

If scale is present on the probe, it will also be forming on the boiler, and a competent water treatment specialist must be consulted as soon as possible.

- Check that all extension connector lock-nuts are tight.
- Inspect the probe controller wiring, and the controller supply wiring.
- Check the controller for damage.
- Reassemble and carry out a full functional check of the equipment.

Available spares

Connector set

Stock No. 4024480
