

# Fig 7, 33, 33.1, 34, 34HP, 36, 36HP, 37, 3616, Fig 3716 and Fig 3616 Food+ Flanged Strainers

## Installation and Maintenance Instructions

---

---

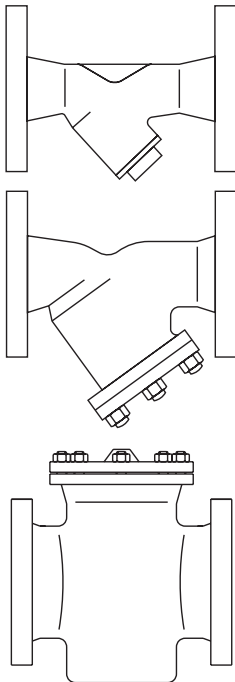

1. Safety information
2. General product information
3. Installation
4. Commissioning
5. Operation
6. Fault finding
7. Maintenance
8. Spare parts

---

Fig 7, 33, 33.1, 34, 34HP, 36, 36HP, 37, 3616, Fig 3716 and Fig 3616 Food+ Flanged Strainers

# 1. Safety information

Safe operation of these products can only be guaranteed if they are properly installed, commissioned, used and maintained by qualified personnel (see Section 1.11) in compliance with the operating instructions. General installation and safety instructions for pipeline and plant construction, as well as the proper use of tools and safety equipment must also be complied with.

## Fig 3616 Food+ DN15 to 100, EC1935/2004 version, safety instructions

Fig 3616 Food+ DN15 to 100, EC1935/2004 version is intended to be connected into a system that can operate an EC1935 compliant process.

To minimise the risk of non-intentionally added substances in the system, it is essential that an appropriate CIP (cleaning in place) cycle is carried out by the end user prior to first use in a food contact application.

A list of the materials that could come directly or indirectly into contact with foodstuffs can be found in the Declaration of Compliance available for this product.

### 1.1 Intended use

Referring to the Installation and Maintenance Instructions, name-plate and Technical Information Sheet, check that the product is suitable for the intended use/application.

The products listed below comply with the requirements of the European Pressure Equipment Directive 2014/68/EU and carry the  mark when so required.

The products fall within the following Pressure Equipment Directives:

Product			Group 2 Gases	Group 2 Liquids
Fig 7	PN16	DN200	2	SEP
		DN250	2	SEP
	ASME 150	DN200 - DN250	2	SEP
Fig 33 Fig 33.1	All connections	DN15 - DN25	SEP	SEP
		DN32 - DN50	SEP	SEP
		DN65 - DN125	1	SEP
		DN150 - DN200	1	SEP

Fig 7, 33, 33.1, 34, 34HP, 36, 36HP, 37, 3616, Fig 3716 and Fig 3616 Food+ Flanged Strainers

Product		Group 2 Gases	Group 2 Liquids	
Fig 34 and Fig 36	PN16	DN15 - DN25	SEP	SEP
		DN32	SEP	SEP
		DN40 - DN50	1	SEP
		DN65 - DN125	1	SEP
		DN150 - DN200	1	SEP
		DN250 - DN300	2	SEP
		DN350 - DN400	3	1
	PN25	DN200	2	SEP
		DN250	2	1
		DN300 - DN400	3	1
	PN40	DN15 - DN25	SEP	SEP
		DN32	SEP	SEP
		DN40 - DN50	1	SEP
		DN65 - DN100	1	SEP
		DN125 - DN200	2	SEP
		DN250	2	1
		DN300 - DN400	3	1

Fig 7, 33, 33.1, 34, 34HP, 36, 36HP, 37, 3616, Fig 3716 and Fig 3616 Food+ Flanged Strainers

Product		Group 2 Gases	Group 2 Liquids
ASME 150	DN15 - DN25	SEP	SEP
	DN32 - DN50	SEP	SEP
	DN65 - DN100	1	SEP
	DN125 - DN150	1	SEP
	DN200 - DN250	2	SEP
	DN300 - DN400	3	1
ASME 300	DN15 - DN25	SEP	SEP
	DN32	SEP	SEP
	DN40 - DN50 Stainless steel	1	SEP
	DN40 - DN50 Carbon steel	1	SEP
	DN65 - DN100	1	SEP
	DN125 - DN200	2	SEP
	DN250	2	1
DN300 - DN400	3	1	
JIS / KS 10	DN15 - DN25	SEP	SEP
	DN32 - DN65	SEP	SEP
	DN80 - DN125	1	SEP
	DN150 - DN250	1	SEP
	DN300 - DN350	2	SEP
	DN400	3	1
JIS / KS 20	DN15 - DN25	SEP	SEP
	DN32	SEP	SEP
	DN40 - DN50	1	SEP
	DN65 - DN100	1	SEP
	DN125 - DN200	2	SEP
	DN250	2	1
	DN300 - DN400	3	1

Fig 34  
and  
Fig 36

Fig 7, 33, 33.1, 34, 34HP, 36, 36HP, 37, 3616, Fig 3716 and Fig 3616 Food+ Flanged Strainers

Product		Group 2 Gases	Group 2 Liquids	
Fig 34HP and Fig 36HP	All connections	DN15 - DN25	SEP	SEP
		DN40 - DN100	SEP	SEP
		DN150 - DN200	2	SEP
Fig 37	PN16	DN15 - DN25	SEP	SEP
		DN32	SEP	SEP
		DN40 - DN50	1	SEP
		DN65 - DN125	1	SEP
		DN150 - DN200	1	SEP
	PN25	DN200	2	SEP
	PN40	DN15 - DN25	SEP	SEP
		DN32	SEP	SEP
		DN40 - DN50	1	SEP
		DN65 - DN100	1	SEP
		DN125 - DN150	2	SEP
	ASME 150	DN15 - DN25	SEP	SEP
		DN32 - DN50	SEP	SEP
		DN65 - DN100	1	SEP
		DN125 - DN200	1	SEP
JIS / KS 10	DN15 - DN25	SEP	SEP	
	DN32 - DN65	SEP	SEP	
	DN80 - DN125	1	SEP	
	DN150 - DN200	1	SEP	
JIS / KS 20	DN15 - DN25	SEP	SEP	
	DN32	SEP	SEP	
	DN40 - DN65	1	SEP	
	DN80 - DN125	1	SEP	
	DN150 - DN200	2	SEP	

Fig 7, 33, 33.1, 34, 34HP, 36, 36HP, 37, 3616, Fig 3716 and Fig 3616 Food+ Flanged Strainers

Product		Group 2 Gases	Group 2 Liquids		
Fig 3616	PN16	DN15 - DN25	SEP	SEP	
		DN32 - DN50	SEP	SEP	
		DN65 - DN125	1	SEP	
		DN150 - DN200	1	SEP	
	ASME 150	DN15 - DN25	SEP	SEP	
		DN32 - DN50	SEP	SEP	
		DN65 - DN100	1	SEP	
		DN125 - DN150	1	SEP	
		DN200	2	SEP	
	JIS / KS 10	DN15 - DN25	SEP	SEP	
		DN32 - DN65	SEP	SEP	
		DN80 - DN125	1	SEP	
		DN150 - DN200	1	SEP	
	Fig 3716	PN16	DN15 - DN25	SEP	SEP
			DN32 - DN50	SEP	SEP
			DN65 - DN125	1	SEP
DN150 - DN200			1	SEP	
ASME 150		DN15 - DN25	SEP	SEP	
		DN32 - DN50	SEP	SEP	
		DN65	1	SEP	
		DN125 - DN200	1	SEP	
JIS / KS 10		DN15 - DN25	SEP	SEP	
		DN32 - DN65	SEP	SEP	
		DN80 - DN125	1	SEP	
		DN150 - DN200	1	SEP	

Fig 7, 33, 33.1, 34, 34HP, 36, 36HP, 37, 3616, Fig 3716 and Fig 3616 Food+ Flanged Strainers

- i) These products have been specifically designed for use on steam, air or water /condensate as stated in Group 2 of the above mentioned Pressure Equipment Directive.
- ii) Check material suitability, pressure and temperature and their maximum and minimum values. If the maximum operating limits of the product are lower than those of the system in which it is being fitted, or if malfunction of the product could result in a dangerous overpressure or overtemperature occurrence, ensure a safety device is included in the system to prevent such over-limit situations.
- iii) Determine the correct installation situation and direction of fluid flow.
- iv) Spirax Sarco products are not intended to withstand external stresses that may be induced by any system to which they are fitted. It is the responsibility of the installer to consider these stresses and take adequate precautions to minimise them.
- v) Remove protection covers from all connections and protective film from all name-plates, where appropriate, before installation on steam or other high temperature applications.
- vi) Prior to use, the user shall ensure the fluid compatibility with the equipment material.

## 1.2 Access

Ensure safe access and if necessary a safe working platform (suitably guarded) before attempting to work on the product. Arrange suitable lifting gear if required.

## 1.3 Lighting

Ensure adequate lighting, particularly where detailed or intricate work is required.

## 1.4 Hazardous liquids or gases in the pipeline

Consider what is in the pipeline or what may have been in the pipeline at some previous time. Consider: flammable materials, substances hazardous to health, extremes of temperature.

## 1.5 Hazardous environment around the product

Consider: explosion risk areas, lack of oxygen (e.g. tanks, pits), dangerous gases, extremes of temperature, hot surfaces, fire hazard (e.g. during welding), excessive noise, moving machinery.

## 1.6 The system

Consider the effect on the complete system of the work proposed. Will any proposed action (e.g. closing isolation valves, electrical isolation) put any other part of the system or any personnel at risk?

Dangers might include isolation of vents or protective devices or the rendering ineffective of controls or alarms. Ensure isolation valves are turned on and off in a gradual way to avoid system shocks.

## 1.7 Pressure systems

Ensure that any pressure is isolated and safely vented to atmospheric pressure. Consider double isolation (double block and bleed) and the locking or labelling of closed valves. Do not assume that the system has depressurised even when the pressure gauge indicates zero.



## 1.8 Temperature

Allow time for temperature to normalise after isolation to avoid danger of burns.

## 1.9 Tools and consumables

Before starting work ensure that you have suitable tools and/or consumables available. Use only genuine Spirax Sarco replacement parts.

## 1.10 Protective clothing

Consider whether you and/or others in the vicinity require any protective clothing to protect against the hazards of, for example, chemicals, high/low temperature, radiation, noise, falling objects, and dangers to eyes and face.

## 1.11 Permits to work

All work must be carried out or be supervised by a suitably competent person.

Installation and operating personnel should be trained in the correct use of the product according to the Installation and Maintenance Instructions.

Where a formal 'permit to work' system is in force it must be complied with. Where there is no such system, it is recommended that a responsible person should know what work is going on and, where necessary, arrange to have an assistant whose primary responsibility is safety.

Post 'warning notices' if necessary.

## 1.12 Handling

Manual handling of large and/or heavy products may present a risk of injury. Lifting, pushing, pulling, carrying or supporting a load by bodily force can cause injury particularly to the back. You are advised to assess the risks taking into account the task, the individual, the load and the working environment and use the appropriate handling method depending on the circumstances of the work being done.

## 1.13 Residual hazards

In normal use the external surface of the product may be very hot. If used at the maximum permitted operating conditions the surface temperature of some products may reach temperatures of 300 °C (572 °F).

Many products are not self-draining. Take due care when dismantling or removing the product from an installation (refer to 'Maintenance instructions').

## 1.14 Freezing

Provision must be made to protect products which are not self-draining against frost damage in environments where they may be exposed to temperatures below freezing point.

## 1.15 Disposal

Unless otherwise stated in the Installation and Maintenance Instructions, this product is recyclable and no ecological hazard is anticipated with its disposal providing due care is taken.

Please visit the Spirax Sarco product compliance web pages:

<https://www.spiraxsarco.com/product-compliance>

for up to date information on any substances of concern that may be contained within this product. Where no additional information is provided on the Spirax Sarco product compliance web page, this product may be safely recycled and/or disposed providing due care is taken. Always check your local recycling and disposal regulations.

## 1.16 Returning products

Customers and stockists are reminded that under EC Health, Safety and Environment Law, when returning products to Spirax Sarco they must provide information on any hazards and the precautions to be taken due to contamination residues or mechanical damage which may present a health, safety or environmental risk. This information must be provided in writing including Health and Safety data sheets relating to any substances identified as hazardous or potentially hazardous.

## 1.17 Working safely with cast iron products on steam

Cast iron products are commonly found on steam and condensate systems. If installed correctly using good steam engineering practices, it is perfectly safe.

However, because of its mechanical properties, it is less forgiving compared to other materials such as SG iron or carbon steel. The following are the good engineering practices required to prevent waterhammer and ensure safe working conditions on a steam system.

### Safe Handling

Cast Iron is a brittle material. If the product is dropped during installation and there is any risk of damage the product should not be used unless it is fully inspected and pressure tested by the manufacturer.

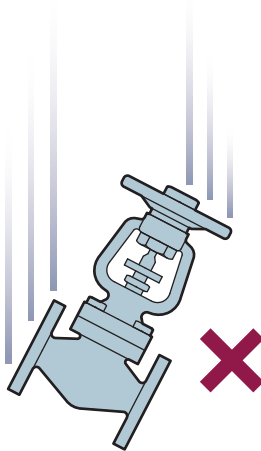
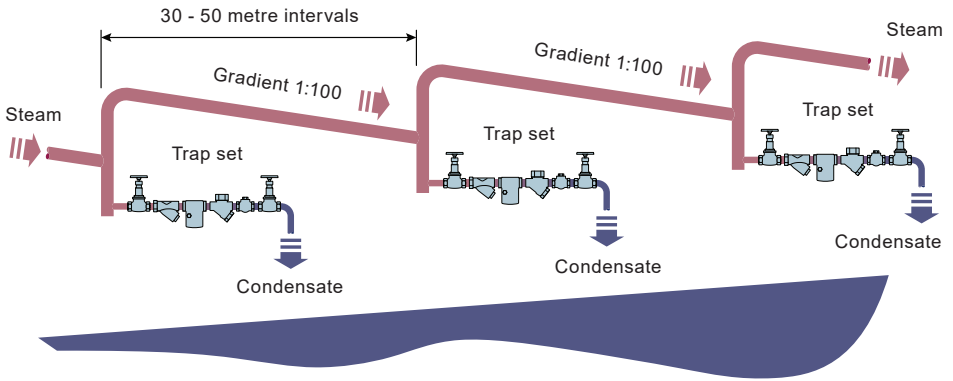

Fig 7, 33, 33.1, 34, 34HP, 36, 36HP, 37, 3616, Fig 3716 and Fig 3616 Food+ Flanged Strainers

## Prevention of waterhammer

Steam trapping on steam mains:



## Steam Mains - Do's and Don'ts:

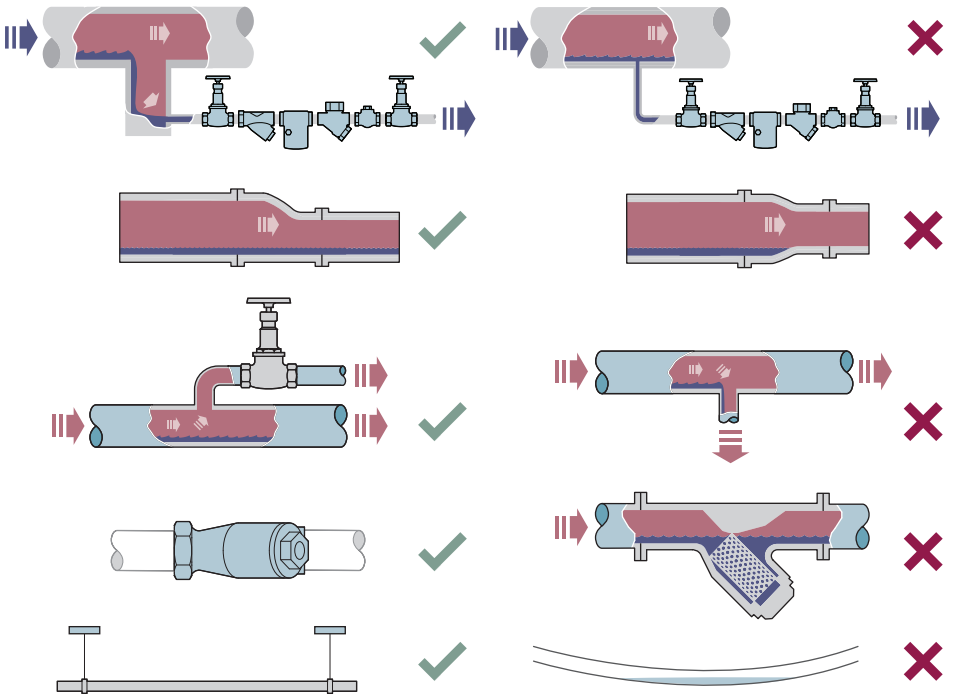
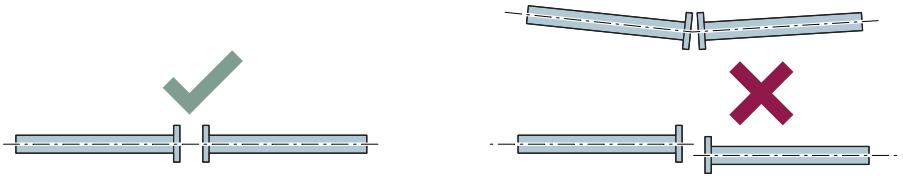

Fig 7, 33, 33.1, 34, 34HP, 36, 36HP, 37, 3616, Fig 3716 and Fig 3616 Food+ Flanged Strainers

# Prevention of tensile stressing

Pipe misalignment:



Installing products or re-assembling after maintenance:



Do not over tighten.  
Use correct torque figures.

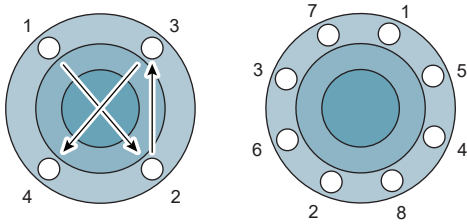

Flange bolts should be gradually tightened across diameters to ensure even load and alignment.

Fig 7, 33, 33.1, 34, 34HP, 36, 36HP, 37, 3616, Fig 3716 and Fig 3616 Food+ Flanged Strainers

**Thermal expansion:**

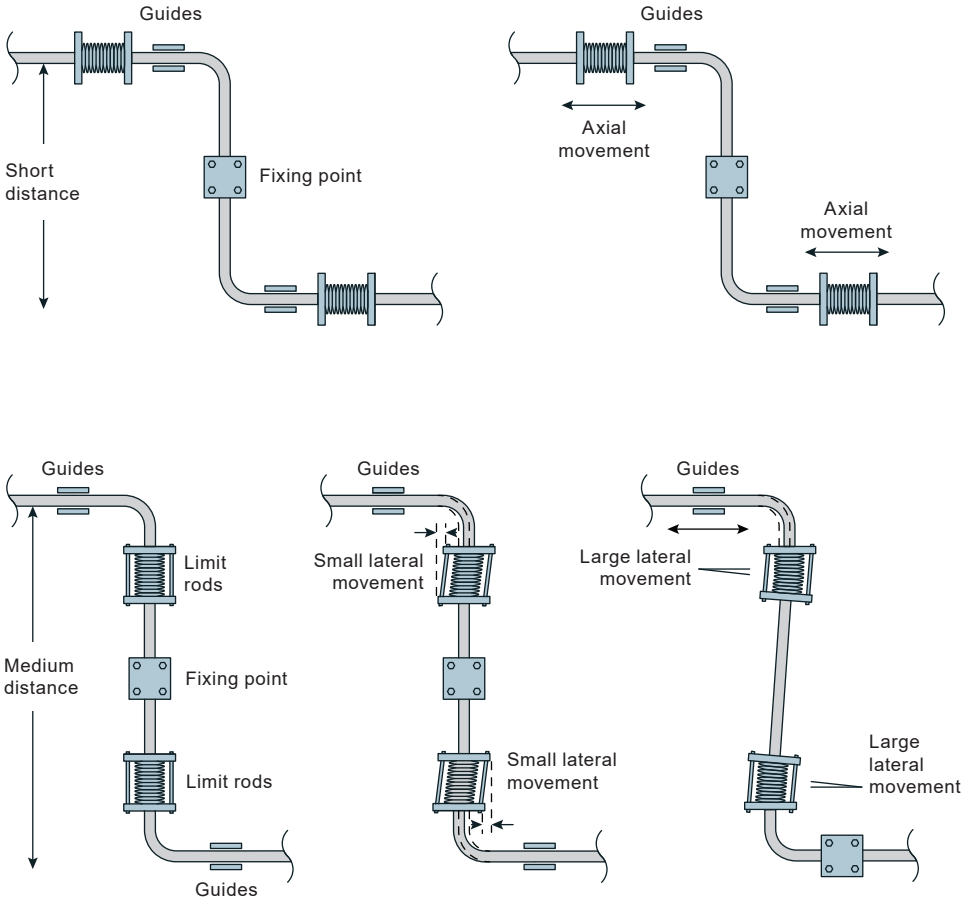

Fig 7, 33, 33.1, 34, 34HP, 36, 36HP, 37, 3616, Fig 3716 and Fig 3616 Food+ Flanged Strainers

## 2. General product information

### 2.1 General description

The products detailed below are all strainers with flanged connections. They are used to protect other pipeline items from damage due to debris and dirt in the system. The Fig 7 strainer is a pot type design - all the others are Y-type designs. The standard stainless steel screen in the DN15 to DN80 sizes has 0.8 mm perforations. In the DN100 to DN200 sizes, they have 1.6 mm perforations. The Fig 7 is fitted with 3.2 mm perforations only (no optional extras are available for the Fig 7). Optional screens are available for the Y-type strainers only, see Section 2.2.

**Note:** For additional information see the following Technical Information Sheets:

Strainer	Body material	Body rating	Size	TI reference
Fig 7	Carbon steel	PN16 - ASME 150	DN200 - DN250 only	TI-P063-03
Fig 33	Cast iron	PN16 - ASME 150	DN15 - DN200	TI-S60-03
Fig 33.1	SG iron	PN16	DN15 - DN200	TI-P166-01
Fig 34 (DIN)	Carbon steel	PN40	DN15 - DN200	TI-P064-01
Fig 34 (ASTM)	Carbon steel	ASME 300	DN15 - DN200	TI-P064-02
Fig 34	Carbon steel	PN40 - ASME 300	DN250 - DN400	TI-P168-07
Fig 34HP	Carbon steel	PN100 - ASME 600	DN15 - DN200	TI-P168-01
Fig 36	Austenitic stainless steel	PN40 - ASME 300	DN15 - DN200	TI-P160-02
Fig 36HP	Austenitic stainless steel	PN100 - ASME 600	DN15 - DN200	TI-P160-11
Fig 37	SG iron	PN40 - ASME 150	DN15 - DN150	TI-P081-01
		PN25 - ASME 150	DN200	TI-P081-01
Fig 3616 (DIN)	Austenitic stainless steel	PN16	DN15 - DN200	TI-P160-05
Fig 3616 (ASTM)	Austenitic stainless steel	ASME 150	DN15 - DN200	TI-P160-04
Fig 3716	SG iron	PN16	DN15 - DN200	TI-P081-03

Fig 7, 33, 33.1, 34, 34HP, 36, 36HP, 37, 3616, Fig 3716 and Fig 3616 Food+ Flanged Strainers

Y-type  
(screwed cap)

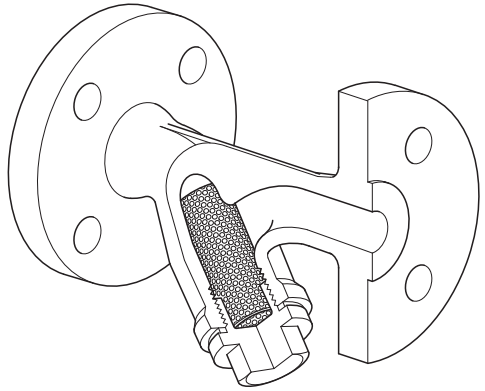
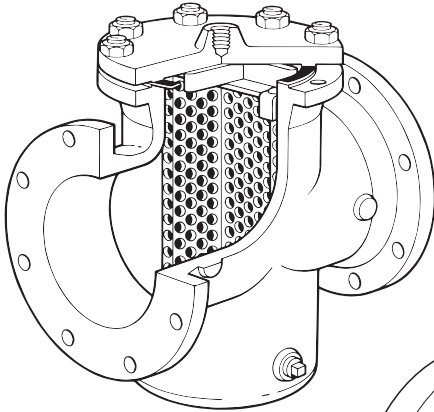

Fig 7



Y-type  
(bolted cap)

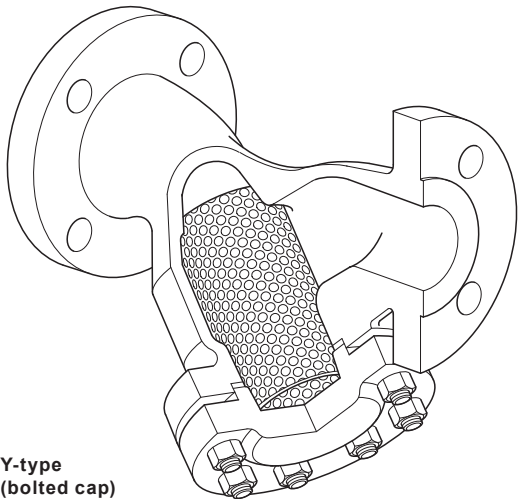

Fig 7, 33, 33.1, 34, 34HP, 36, 36HP, 37, 3616, Fig 3716 and Fig 3616 Food+ Flanged Strainers

## 2.2 Optional extras

<b>Strainer screens</b>	<b>Stainless steel screen</b>	Perforations	1.6, 3 mm
		Mesh	40, 100, 200
	<b>Monel screen</b> (Not available for the Fig 3716)	Perforations	0.8, 3 mm
		Mesh	100

### Blowdown or drain valve connections

The cap can be drilled and tapped to the following sizes to enable a blowdown or drain valve to be fitted.

<b>Strainer</b>	<b>Size</b>	<b>Blowdown valve</b>	<b>Drain valve</b>
<b>Fig 33</b> <b>Fig 33.1</b> <b>Fig 34</b>	<b>DN15</b>	¼"	¼"
	<b>DN20 - DN25</b>	½"	½"
	<b>DN32 - DN40</b>	1"	¾"
	<b>DN50 - DN125</b>	1¼"	¾"
	<b>DN150 - DN200</b>	2"	¾"
	<b>DN250 - DN400</b>	2"	2"
<b>Fig 34HP</b> <b>Fig 36HP</b>	<b>DN15</b>	⅜"	⅜"
	<b>DN20</b>	½"	⅜"
	<b>DN25</b>	¾"	½"
	<b>DN40</b>	1"	½"
	<b>DN50</b>	1"	¾"
	<b>DN65</b>	1¼"	¾"
	<b>DN80</b>	1½"	¾"
	<b>DN100</b>	1½"	1"
	<b>DN150</b>	2"	1"
<b>Fig 36</b> <b>Fig 37</b>	<b>DN15</b>	¼"	¼"
	<b>DN20 - DN25</b>	½"	½"
	<b>DN32 - DN40</b>	1"	¾"
	<b>DN50 - DN125</b>	1¼"	¾"
	<b>DN150 - DN200</b>	2"	¾"
<b>Fig 3616 *</b> <b>Fig 3716 *</b>	<b>DN15 - DN20</b>	⅜"	⅜"
	<b>DN25 - DN32</b>	½"	½"
	<b>DN40 - DN80</b>	¾"	¾"
	<b>DN100 - DN200</b>	1"	¾"

\* **Note:** The Fig 3616 and Fig 3716 can be supplied with ¼" tappings for pressure monitoring (upstream and downstream) of the strainer screen.

Fig 7, 33, 33.1, 34, 34HP, 36, 36HP, 37, 3616, Fig 3716 and Fig 3616 Food+ Flanged Strainers



## 2.3 Pressure/temperature limits (ISO 6552)

**Note:** Values for PMA and TMA are not concurrent for exact operating limits.

**Fig 7**

Body design conditions	PN16	
PMA - Maximum allowable pressure	16 bar g	(232 psi g)
TMA - Maximum allowable temperature	300 °C	(572 °F)
Minimum operating temperature	0 °C	(32 °F)
Product is safe for use under full vacuum conditions.		
Designed for a maximum cold hydraulic test pressure of:	28 bar g	(406 psi g)

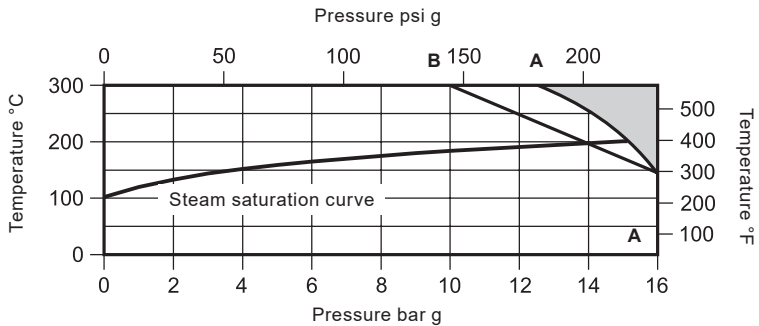

The product **must not** be used in this region.

**A - A** Flanged EN 1092 PN16

**B -A** Flanged ASME 150

**Fig 7, 33, 33.1, 34, 34HP, 36, 36HP, 37, 3616, Fig 3716 and Fig 3616 Food+ Flanged Strainers**

**Fig 33**

Body design conditions		PN16	
PMA	Maximum allowable pressure	16 bar g	(232 psi g)
TMA	Maximum allowable temperature	300 °C	(572 °F)
Minimum operating temperature		0 °C	(32 °F)
Product is safe for use under full vacuum conditions			
Designed for a maximum cold hydraulic test pressure of:		24 bar g	(348 psi g)

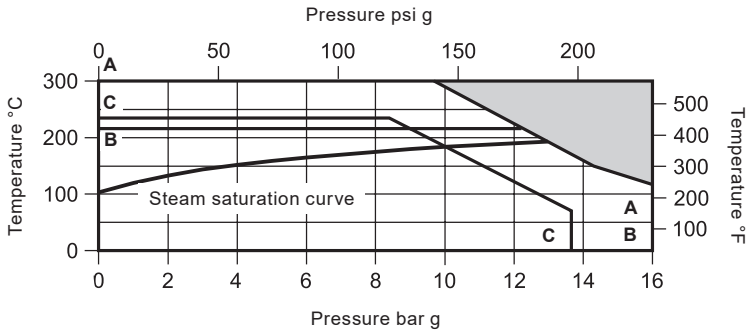

The product **must not** be used in this region.

- A - A** Flanged EN 1092 PN16
- B - B** Flanged AS 2129 Table F
- C - C** Flanged ASME 125 (including DN15, DN20 flanged ASME 150)

**Fig 33.1**

Body design conditions			PN16
PMA	Maximum allowable pressure	16 bar g	(232 psi g)
TMA	Maximum allowable temperature	350 °C	(662 °F)
Minimum allowable temperature		-10 °C	(14 °F)
PMO	Maximum operating pressure for saturated steam service	14.7 bar g	(213 psi g)
TMO	Maximum operating temperature	350 °C	(662 °F)
Minimum operating temperature		-10 °C	(14 °F)
Product is safe for use under full vacuum conditions.			
Designed for a maximum cold hydraulic test pressure of:		24 bar g	(348 psi g)

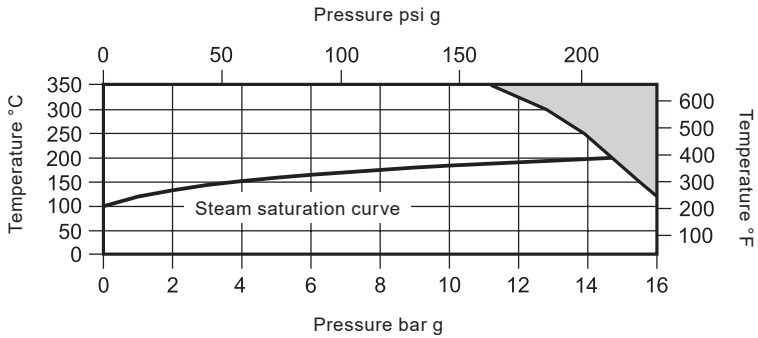

The product **must not** be used in this region.

Fig 7, 33, 33.1, 34, 34HP, 36, 36HP, 37, 3616, Fig 3716 and Fig 3616 Food+ Flanged Strainers

**Fig 34 (DIN and JIS/KS)**

Body design conditions		PN40	
		PN40	40 bar g @ 50 °C (580 psi g @ 122 °F)
		PN25	25 bar g @ 50 °C (362 psi g @ 122 °F)
PMA	Maximum allowable pressure	PN16	16 bar g @ 50 °C (232 psi g @ 122 °F)
		JIS/KS 20	34 bar g @ 120 °C (493 psi g @ 248 °F)
		JIS/KS 10	14 bar g @ 120 °C (203 psi g @ 248 °F)
TMA	Maximum allowable temperature	PN40	400 °C @ 23.8 bar g (752 °F @ 345 psi g)
		PN25	400 °C @ 14.8 bar g (752 °F @ 214 psi g)
		PN16	400 °C @ 9.5 bar g (752 °F @ 138 psi g)
		JIS/KS 20	425 °C @ 20 bar g (797 °F @ 290 psi g)
		JIS/KS 10	300 °C @ 10 bar g (572 °F @ 145 psi g)
Minimum operating temperature		-29 °C	(-20 °F)
Product is safe for use under full vacuum conditions			
Designed for a maximum cold hydraulic test pressure of 1.5 x PMA of the connection of choice			

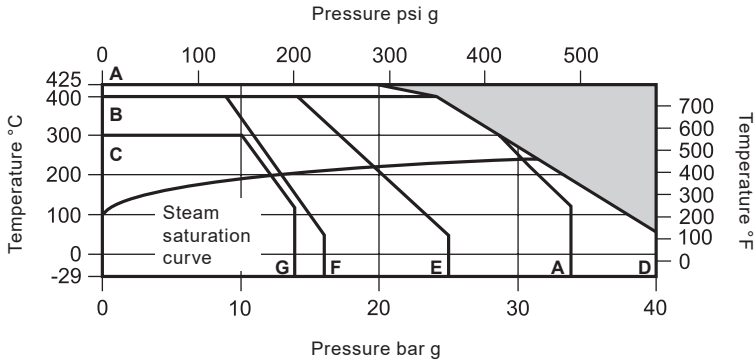

The product **must not** be used in this region.

- A - A Flanged JIS/KS 20
- B - D Flanged EN 1092 PN40
- B - E Flanged EN 1092 PN25
- B - F Flanged EN 1092 PN16
- C - G Flanged JIS/KS 10

**Fig 7, 33, 33.1, 34, 34HP, 36, 36HP, 37, 3616, Fig 3716 and Fig 3616 Food+ Flanged Strainers**

**Fig 34 (ASTM)**

Body design conditions		ASME 300		
PMA	Maximum allowable pressure	ASME 150	19.6 bar g @ 38 °C	(284 psi g @ 100 °F)
		ASME 300	51.1 bar g @ 38 °C	(741 psi g @ 100 °F)
TMA	Maximum allowable temperature	ASME 150	425 °C @ 5.5 bar g	(797 °F @ 80 psi g)
		ASME 300	425 °C @ 28.8 bar g	(797 °F @ 418 psi g)
Minimum operating temperature			-29 °C	(-20 °F)
Product is safe for use under full vacuum conditions				
Designed for a maximum cold hydraulic test pressure of 1.5 x PMA of the connection of choice				

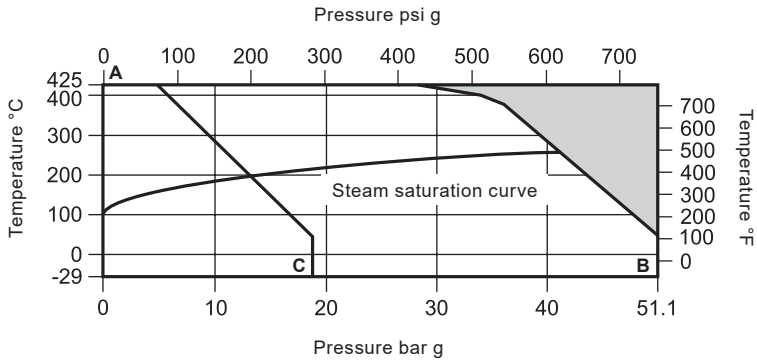

The product **must not** be used in this region.

A - A Flanged ASME 300

A - C Flanged ASME 150

Fig 7, 33, 33.1, 34, 34HP, 36, 36HP, 37, 3616, Fig 3716 and Fig 3616 Food+ Flanged Strainers

**Fig 34HP (DIN)**

Body design conditions		PN63 and PN100		
PMA	Maximum allowable pressure	PN63	63 bar g @ 50 °C	(914 psi g @ 122 °F)
		PN100	100 bar g @ 50 °C	(1 450 psi g @ 122 °F)
TMA	Maximum allowable temperature	PN63	400 °C @ 37.5 bar g	(752 °F @ 544 psi g)
		PN100	400 °C @ 59.5 bar g	(752 °F @ 863 psi g)
Minimum operating temperature			-29 °C	(-20 °F)
Product is safe for use under full vacuum conditions				
Designed for a maximum cold hydraulic test pressure of:	PN63	95 bar g	(1 378 psi g)	
	PN100	150 bar g	(2 176 psi g)	

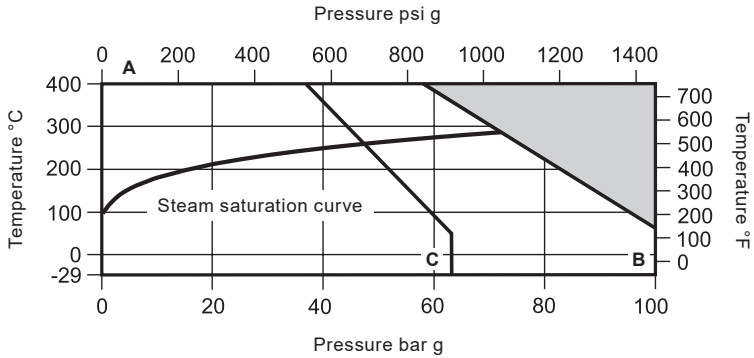

The product **must not** be used in this region.

**A - B** Flanged PN100

**A - C** Flanged PN63

**Fig 34HP (ASTM)**

Body design conditions		ASME 600	
PMA	Maximum allowable pressure	102 bar g @ 38 °C	(1480 psi g @ 100 °F)
TMA	Maximum allowable temperature	425 °C @ 57.5 bar g	(797 °F @ 833 psi g)
Minimum operating temperature		-29 °C	(-20 °F)
Product is safe for use under full vacuum conditions			
Designed for a maximum cold hydraulic test pressure of:		152 bar g	(2 204 psi g)

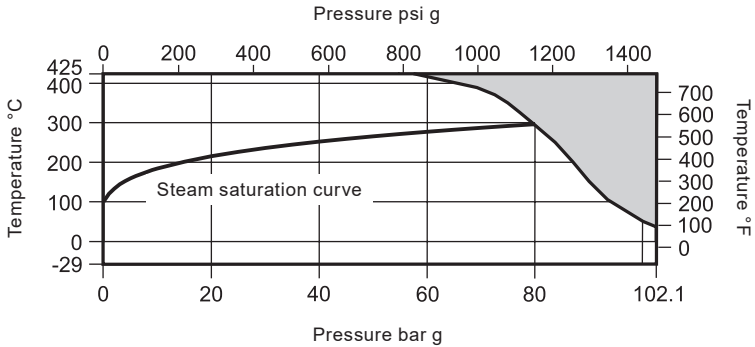

 The product **must not** be used in this region.

Fig 7, 33, 33.1, 34, 34HP, 36, 36HP, 37, 3616, Fig 3716 and Fig 3616 Food+ Flanged Strainers

## Fig 36HP

**A - B** Flanged ASME B16.5 Class 600, ASME 600 RTJ,  
Screwed NPT, Socket weld ASME B16.11 Class 3000 and  
Butt weld ASME B 16.25 Schedule 40 and Schedule 80

Body design conditions		ASME 600	
PMA	Maximum allowable pressure	99.3 bar g	(1440 psi g)
TMA	Maximum allowable temperature	538 °C	(1000 °F)
Minimum operating temperature		-29 °C	(-20 °F)
Product is safe for use under full vacuum conditions			
Designed for a maximum cold hydraulic test pressure of:		153 bar g	(2219 psi g)

**A - C** Flanged EN 1092 PN100 and Screwed BSP T Rp (ISO 7-1)

Body design conditions		PN100	
PMA	Maximum allowable pressure	100 bar g	(1450 psi g)
TMA	Maximum allowable temperature	538 °C	(1000 °F)
Minimum operating temperature		-29 °C	(-20 °F)
Product is safe for use under full vacuum conditions			
Designed for a maximum cold hydraulic test pressure of:		150 bar g	(2175 psi g)

**A - D** Flanged EN 1092 PN63

Body design conditions		PN63	
PMA	Maximum allowable pressure	63 bar g	(913 psi g)
TMA	Maximum allowable temperature	538 °C	(1000 °F)
Minimum operating temperature		-29 °C	(-20 °F)
Product is safe for use under full vacuum conditions			
Designed for a maximum cold hydraulic test pressure of:		95 bar g	(1377 psi g)

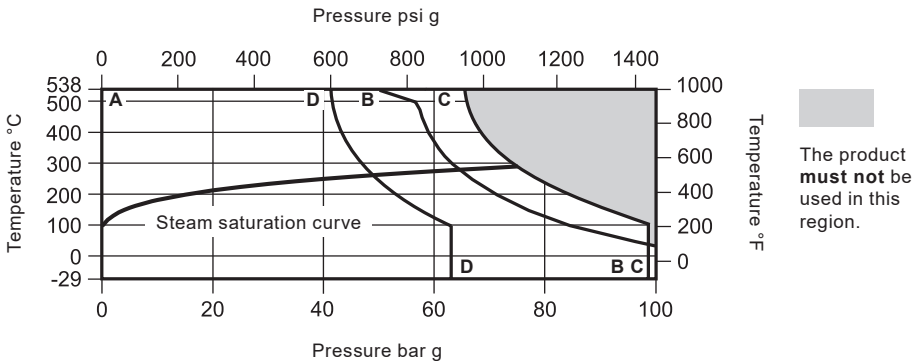
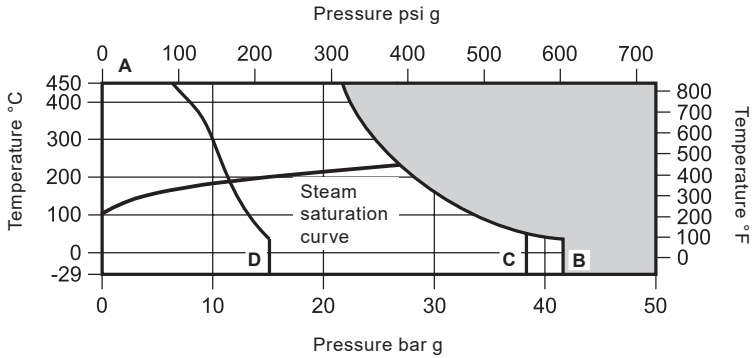

Fig 7, 33, 33.1, 34, 34HP, 36, 36HP, 37, 3616, Fig 3716 and Fig 3616 Food+ Flanged Strainers



**Fig 36**

Body design conditions		ASME 300 or PN50	
PMA	Maximum allowable pressure	41 bar g	(595 psi g)
TMA	Maximum allowable temperature	450 °C	(842 °F)
Minimum operating temperature		-29 °C	(-20 °F)
Product is safe for use under full vacuum conditions			
Designed for a maximum cold hydraulic test pressure of:		76 bar g	(1 102 psi g)



The product **must not** be used in this region.

- A - B Flanged PN100
- A - C Flanged PN63
- C - D Flanged ASME/ANSI 150

**Fig 37**

Body design conditions		DN200 only	PN40	PN25
PMA	Maximum allowable pressure	DN200 only	40 bar g (580 psi g)	25 bar g (363 psi g)
TMA	Maximum allowable temperature		350 °C (662 °F)	0 °C (32 °F)
Minimum operating temperature		DN65 and above	0 °C (32 °F)	
Product is safe for use under full vacuum conditions				
Designed for a maximum cold hydraulic test pressure of:		PN40	60 bar g (870 psi g)	
		PN25 DN200 only	38 bar g (551 psi g)	

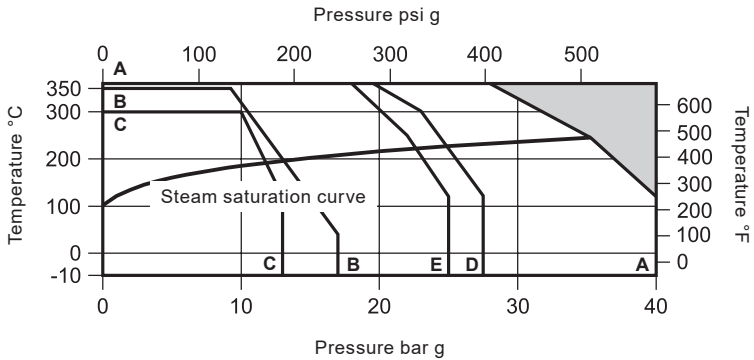

The product **must not** be used in this region.

- A - B Flanged EN 1092 PN40
- A - D Flanged JIS/KS 20K
- A - E Flanged EN 1092 PN25
- B - B Flanged ASME 150
- C - C Flanged JIS/KS 10K

**Fig 7, 33, 33.1, 34, 34HP, 36, 36HP, 37, 3616, Fig 3716 and Fig 3616 Food+ Flanged Strainers**

**Fig 3616 (DIN)**

Body design conditions		PN16	
PMA	Maximum allowable pressure	15.7 bar g	(227.7 psi g)
	Maximum EC1935/2004 allowable pressure	13.4 bar g	(174 psi g)
TMA	Maximum allowable temperature	300 °C	(572 °F)
	Maximum EC1935/2004 allowable temperature	200°C	(392°F)
Minimum operating temperature		10 °C	(14 °F)
Product is safe for use under full vacuum conditions			
Designed for a maximum cold hydraulic test pressure of:		24 bar g	(348 psi g)

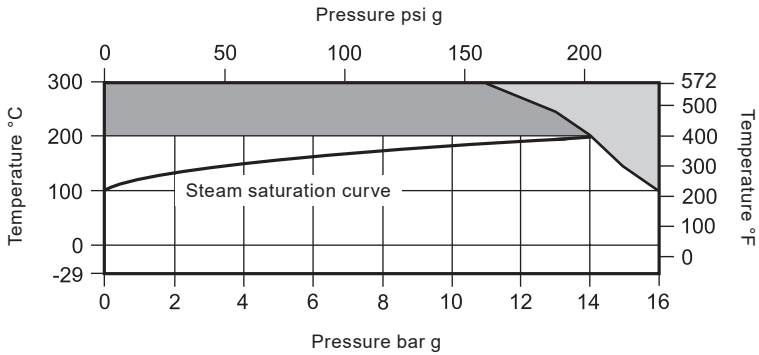

 The product **must not** be used in this region.

 EC1935/2004 product **must not** be used in this region.

**Fig 7, 33, 33.1, 34, 34HP, 36, 36HP, 37, 3616, Fig 3716 and Fig 3616 Food+ Flanged Strainers**

**Fig 3616 (ASTM)**

Body design conditions		ASME 150	
PMA	Maximum allowable pressure	19 bar g	(275.5 psi g)
TMA	Maximum allowable temperature	400 °C	(752 °F)
Minimum operating temperature		-29 °C	(-20 °F)
Product is safe for use under full vacuum conditions			
Designed for a maximum cold hydraulic test pressure of:		30 bar g	(435 psi g)

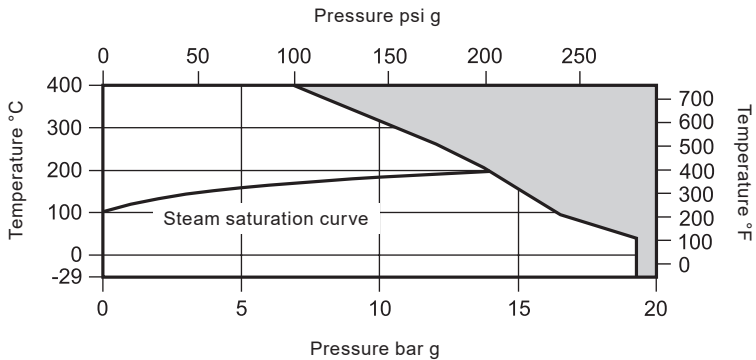



 The product **must not** be used in this region.

Fig 7, 33, 33.1, 34, 34HP, 36, 36HP, 37, 3616, Fig 3716 and Fig 3616 Food+ Flanged Strainers

**Fig 3716 (DIN)**

Body design conditions		PN16	
PMA	Maximum allowable pressure	16 bar g	(232 psi g)
TMA	Maximum allowable temperature	300 °C	(662 °F)
Minimum operating temperature		-10 °C	(14 °F)
Product is safe for use under full vacuum conditions			
Designed for a maximum cold hydraulic test pressure of:		24 bar g	(348 psi g)

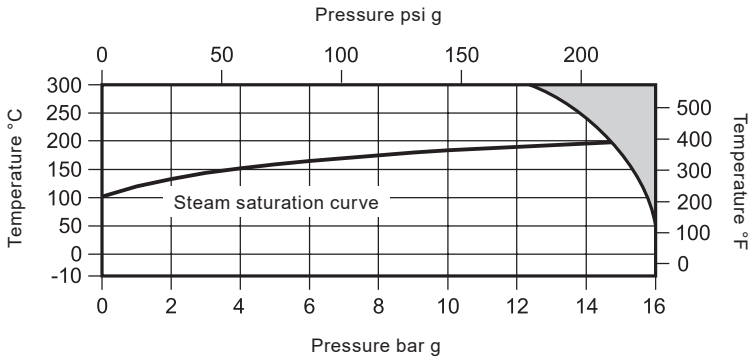

 The product **must not** be used in this region.

## 2.4 Body marking information

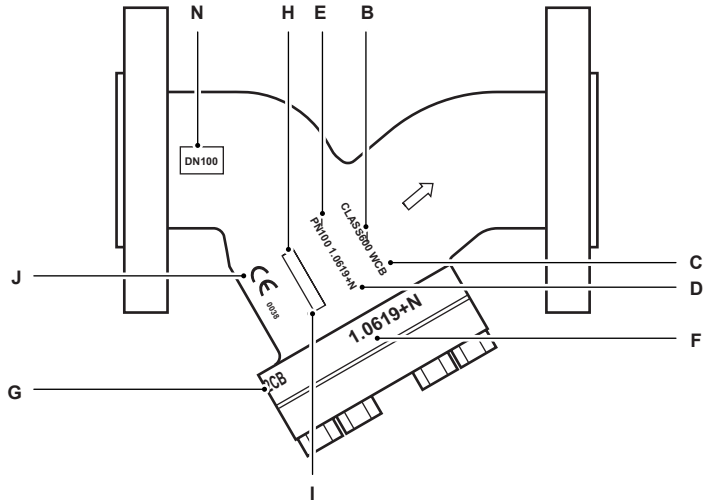

Part	Material						
	Body					Cover	
	A	B	C	D	E	F	G
Fig 7	Fig 7	A216 WCB					
Fig 33	Fig 33	GG 20			PN16		
Fig 33.1	Fig 33.1	JS 1030					
Fig 34HP	Fig 34HP or 34HP	ASME 600	WCB	1.0619+N	PN100	1.0619+N	WCB
Fig 34HP UE	Fig 34HP or 34HP	ASME 600	WCB	1.0619+N	PN100	1.0460	A105N
Fig 34 ASME 150	Fig 34	ASME 150	WCB			C22.8	A105N
Fig 34 ASME 300	Fig 34	ASME 300	WCB			1.0619+N	WCB
Fig 34 EN	Fig 34			1.0619+N or 1.0619+QT	PN40	C22.8	A105N
Fig 36	Fig 36	ASME 300	CF3M	1.4404	PN40		316L
Fig 37	Fig 37	GGG.40			PN40	C22.8	A105N
Fig 3616 ASTM	Fig 3616	ASME 150	CF8M			1.0619+N	WCB
Fig 3616 EN	Fig 3616			1.4408	PN16	1.4401	316L
Fig 3716	Fig 3716	GGG.40			PN16	GGG.40	

Fig 7, 33, 33.1, 34, 34HP, 36, 36HP, 37, 3616, Fig 3716 and Fig 3616 Food+ Flanged Strainers

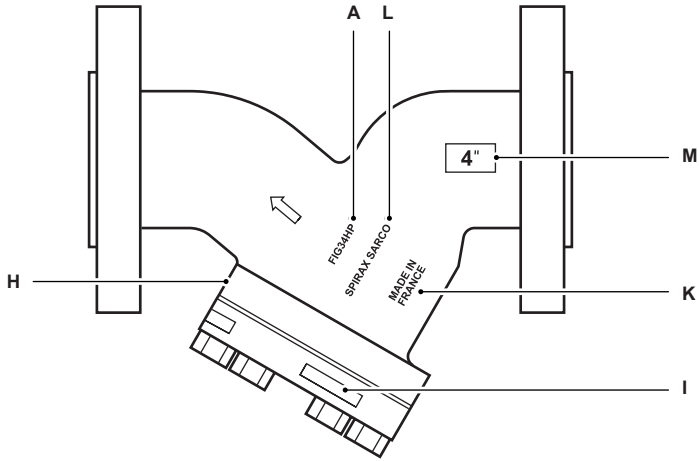

Foundry identification	Melt number	CE marking if necessary	CE0038	Made in France	SPIRAX SARCO or SXS or SPIRAX	DN
H	I		J	K	L	M
•	•		DN200 to DN250	•	•	•
•	•	DN32 to DN50	DN65 to DN200	• Made in China	•	•
•	•		DN25 to DN200	•	•	•
•	•		DN32 to DN200	•	•	•
•	•			•	•	•
•	•			•	•	•
•	•			•	•	•
•	•			•	•	•
•	•			•	•	•
•	•			•	•	•
•	•			•	•	•
•	•			•	•	•
•	•			•	•	•
•	•	DN32 to DN50	DN65 to DN200	•	•	•
•	•			•	•	•

Fig 7, 33, 33.1, 34, 34HP, 36, 36HP, 37, 3616, Fig 3716 and Fig 3616 Food+ Flanged Strainers

## 3. Installation

**Note: Before actioning any installation observe the 'Safety information' in Section 1.**

Referring to the installation and Maintenance Instructions, name-plate and Technical Information Sheet, check that the product is suitable for the intended installation:

- 3.1** Check materials, pressure and temperature and their maximum values. If the maximum operating limit of the product is lower than that of the system in which it is being fitted, ensure that a safety device is included in the system to prevent overpressurisation.
- 3.2** Determine the correct installation situation and the direction of fluid flow.
- 3.3** Remove protection covers from all connections and protective film from all name-plates, where appropriate, before installation on steam or other high temperature applications.
- 3.4** Strainers can be fitted on liquid or steam/gas systems in either horizontal pipework or vertical pipework where the flow is downward. In a horizontal line on steam/gases the strainer pocket should be in the horizontal plane as this reduces the possibility of waterhammer. On liquid systems the strainer pocket should point downwards.
- 3.5** The strainers may be lagged if required.

## 4. Commissioning

After installation or maintenance ensure that the system is fully functional. Carry out tests on any alarms or protective devices.

## 5. Operation

Strainers are passive items and will prevent the onward movement of dirt and debris, which is larger than the holes in the screen. The pressure drop across the strainer will increase as the screen becomes blocked. Regular cleaning/blowdown is recommended to keep the screen clean.



# 6. Fault finding

Symptom	Possible cause	Remedy
No flow through strainer	Blocked screen	Clean or replace screen See Section 7.2
	System is isolated	Check isolation valves
Increased pressure drop across strainer	Screen is blocked up	Clean or replace screen See Section 7.2

Strainer installed on steam or gas

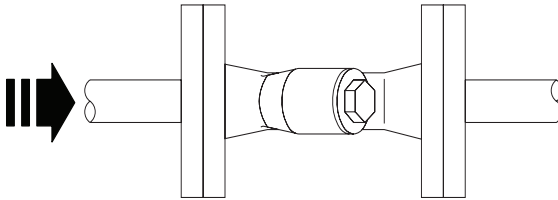

Strainer installed on liquid

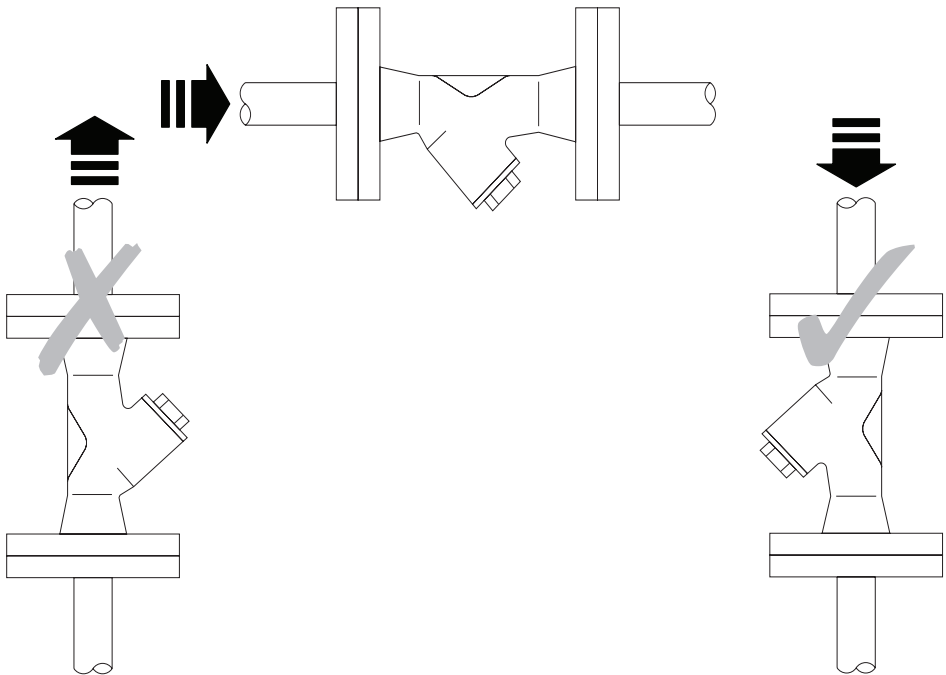

Fig 7, 33, 33.1, 34, 34HP, 36, 36HP, 37, 3616, Fig 3716 and Fig 3616 Food+ Flanged Strainers

# 7. Maintenance

**Note:** Before actioning any maintenance programme observe the 'Safety information' in Section 1.

## Warning

The cover gasket contains a thin stainless steel support ring which may cause physical injury if not handled and disposed of carefully.

## 7.1 General information



Before undertaking any maintenance on the strainer, it must be isolated from both the supply line and return line and any pressure allowed to safely normalise to atmosphere. The trap should then be allowed to cool. When reassembling, ensure that all joint faces are clean.

## 7.2 How to clean or replace the strainer screen:

For identification of parts refer to Section 8 'Spare parts'

- Remove the strainer cap.
- On most sizes up to DN25 the cap is simply unscrewed.
- On all other sizes the cap is retained by bolts/nuts. The number of bolts/nuts used will depend on the strainer size, material of construction and design rating.
- Once the cap is removed the strainer screen can be taken out.
- Clean the screen or replace with a new one.
- Reassemble the screen into the cap by pushing the end into the recess.
- Always fit a new strainer cap gasket ensuring the jointing faces are clean.
- Refit the strainer cap or bolts/nuts using 'Neverseize' compound and tighten to the recommended torque (refer to the relevant Table, pages 35 to 39).
- Ensure that the nuts are tightened equally before final torque is applied.
- Check for leaks.

**Fig 7 strainer - Recommended tightening torques**

Item	Qty	Size	 or mm		N m	(lbf ft)
6	8	DN200	(3/4 UNC) to		80 - 90	(59 - 66)
	10	DN250	BS 1769		110 - 120	(81 - 88)
7	1	DN200		3/4" BSP	50 - 55	(37 - 40)
	1	DN250		1" BSP	50 - 55	(37 - 40)

**Fig 33 and Fig 33.1 strainer - Recommended tightening torques**





Item	Qty	Size	 or mm		N m	(lbf ft)
2	1	DN15	22 A/F	M28	50 - 55	(37 - 40)
	1	DN20	27 A/F	M32	60 - 66	(44 - 49)
	1	DN25	27 A/F	M42	100 - 110	(74 - 81)
	1	DN32	41 A/F	M56	150 - 165	(110 - 121)
	1	DN40	41 A/F	M60	170 - 185	(125 - 136)
	1	DN50	55 A/F	M72	190 - 210	(140 - 154)
5	8	DN65	19 A/F	M12 x 40	20 - 24	(15 - 18)
	8	DN80	19 A/F	M12 x 40	30 - 35	(22 - 26)
	8	DN100	24 A/F	M16 x 50	70 - 77	(51 - 57)
	8	DN125	24 A/F	M16 x 50	80 - 88	(59 - 65)
	8	DN150	30 A/F	M20 x 60	100 - 110	(74 - 81)
	12	DN200	30 A/F	M20 x 70	90 - 100	(66 - 74)



Fig 7, 33, 33.1, 34, 34HP, 36, 36HP, 37, 3616, Fig 3716 and Fig 3616 Food+ Flanged Strainers

**Fig 34 strainer - Recommended tightening torques**

Item	Qty	Size	or		N m	(lbf ft)
				mm 		
2	1	DN15	22 A/F	M28	50 - 55	(37 - 40)
	1	DN20	27 A/F	M32	60 - 66	(44 - 49)
	1	DN25	27 A/F	M42	100 - 110	(74 - 87)
5	4	DN32	19 A/F	M12 x 30	20 - 24	(15 - 18)
	4	DN40	19 A/F	M12 x 30	20 - 24	(15 - 18)
	6	DN50	19 A/F	M12 x 35	20 - 24	(15 - 18)
	8	DN65	19 A/F	M12 x 35	20 - 24	(15 - 18)
	8	DN80	19 A/F	M12 x 35	30 - 35	(22 - 26)
	8	DN100	24 A/F	M16 x 45	50 - 55	(37 - 40)
	8	DN125	30 A/F	M20 x 50	70 - 77	(51 - 57)
	8	DN150	30 A/F	M20 x 55	80 - 88	(59 - 65)
	12	DN200	36 A/F	M24 x 65	120 - 130	(88 - 96)
6	16	DN250 EN and				
		10" ASME 150	1¼"	¾" - 10UNC	160 - 180	(119 - 132)
	16	10" ASME 300	1 <sup>7</sup> / <sub>16</sub> "	7 <sup>8</sup> / <sub>8</sub> " - 9UNC	180 - 200	(132 - 147)
	16	DN300 EN and				
		12" ASME 150	1¼"	¾" - 10UNC	200 - 220	(147 - 162)
	18	12" ASME 300	1 <sup>7</sup> / <sub>16</sub> "	7 <sup>8</sup> / <sub>8</sub> " - 9UNC	210 - 230	(155 - 170)
	20	DN350 EN and				
		14" ASME 150	1¼"	¾" - 10UNC	220 - 240	(162 - 177)
	22	14" ASME 300	1 <sup>7</sup> / <sub>16</sub> "	7 <sup>8</sup> / <sub>8</sub> " - 9UNC	230 - 250	(170 - 184)
	22	DN400 EN and				
	16" ASME 150	1 <sup>7</sup> / <sub>16</sub> "	7 <sup>8</sup> / <sub>8</sub> " - 9UNC	330 - 350	(244 - 258)	
16	16" ASME 300	1 <sup>13</sup> / <sub>16</sub> "	1 <sup>1</sup> / <sub>8</sub> " - 7UNC	380 - 400	(281 - 295)	

**Fig 7, 33, 33.1, 34, 34HP, 36, 36HP, 37, 3616, Fig 3716 and Fig 3616 Food+ Flanged Strainers**

**Fig 34HP strainer - Recommended tightening torques**

Item	Qty	Size	 or mm		N m	(lbf ft)
5	4	DN15	¾" A/F	½" - 13 UNC	20 - 30	(15 - 20)
	4	DN20	¾" A/F	½" - 13 UNC	20 - 30	(15 - 20)
	4	DN25	¾" A/F	½" - 13 UNC	20 - 30	(15 - 20)
	8	DN40	¾" A/F	½" - 13 UNC	30 - 40	(22 - 29)
	8	DN50	¾" A/F	½" - 13 UNC	30 - 40	(22 - 29)
	8	DN65	1 <sup>1</sup> / <sub>16</sub> " A/F	5 <sup>5</sup> / <sub>8</sub> " - 11 UNC	50 - 60	(37 - 44)
	8	DN80	1 <sup>1</sup> / <sub>16</sub> " A/F	5 <sup>5</sup> / <sub>8</sub> " - 11 UNC	50 - 60	(37 - 44)
	8	DN100	1 <sup>1</sup> / <sub>4</sub> " A/F	¾" - 10 UNC	80 - 90	(59 - 66)
	8	DN150	1 <sup>7</sup> / <sub>16</sub> " A/F	7 <sup>7</sup> / <sub>8</sub> " - 9 UNC	100 - 110	(74 - 81)
	12	DN200	1 <sup>13</sup> / <sub>16</sub> " A/F	1 <sup>1</sup> / <sub>8</sub> " - 7 UNC	180 - 190	(133 - 140)

**Fig 36 strainer - Recommended tightening torques**





Item	Qty	Size	 or mm		N m	(lbf ft)
5	4	DN15 and DN20	17 A/F	M10 x 25	22 - 25	(16 - 18)
	4	DN25	17 A/F	M10 x 25	22 - 25	(16 - 18)
	4	DN32 and DN40	19 A/F	M12 x 35	40 - 45	(29 - 33)
	8	DN50	19 A/F	M12 x 35	40 - 45	(29 - 33)
	8	DN65	19 A/F	M12 x 45	40 - 45	(29 - 33)
	8	DN80	19 A/F	M12 x 50	40 - 45	(29 - 33)
	8	DN100	24 A/F	M16 x 50	100 - 110	(73 - 80)
	8	DN125	30 A/F	M20 x 60	160 - 170	(117 - 125)
	8	DN150	30 A/F	M20 x 65	210 - 230	(154 - 169)
	8	DN200	36 A/F	M20 x 75	210 - 230	(154 - 169)

Fig 7, 33, 33.1, 34, 34HP, 36, 36HP, 37, 3616, Fig 3716 and Fig 3616 Food+ Flanged Strainers

**Fig 36HP strainer - Recommended tightening torques**

Item	Qty	Size		or mm		N m	(lbf ft)
5	4	DN15	¾" A/F		½" - 13 UNC	20 - 30	(15 - 20)
	4	DN20	¾" A/F		½" - 13 UNC	20 - 30	(15 - 20)
	4	DN25	¾" A/F		½" - 13 UNC	20 - 30	(15 - 20)
	6	DN40	¾" A/F		½" - 13 UNC	30 - 40	(22 - 29)
	6	DN50	¾" A/F		½" - 13 UNC	30 - 40	(22 - 29)
	6	DN65	1 1/16" A/F		5/8" - 11 UNC	50 - 60	(37 - 44)
	6	DN80	1 1/16" A/F		5/8" - 11 UNC	50 - 60	(37 - 44)
	6	DN100	1 ¼" A/F		¾" - 10 UNC	80 - 90	(59 - 66)
	8	DN150	1 7/16" A/F		7/8" - 9 UNC	100 - 110	(74 - 81)
	8	DN200	1 13/16" A/F		1 1/8" - 7 UNC	180 - 190	(133 - 140)

**Fig 37 strainer - Recommended tightening torques**







Item	Qty	Size		or mm		N m	(lbf ft)
5	1	DN15	22 A/F		M28	50 - 55	(37 - 40)
	1	DN20	27 A/F		M32	60 - 66	(44 - 49)
	1	DN25	27 A/F		M42	100 - 110	(74 - 81)
	1	DN32	46 A/F		M56	250 - 275	(184 - 202)
	1	DN40	50 A/F		M60	250 - 275	(184 - 202)
	1	DN50	60 A/F		M72	310 - 340	(228 - 250)
	8	DN65	19 A/F		M12 x 35	20 - 24	(15 - 18)
	8	DN80	19 A/F		M12 x 35	30 - 35	(19 - 26)
	8	DN100	24 A/F		M16 x 45	70 - 77	(37 - 40)
	8	DN125	30 A/F		M20 x 50	80 - 88	(59 - 65)
	8	DN150	30 A/F		M20 x 55	100 - 110	(74 - 81)
	12	DN200	36 A/F		M24 x 65	090 - 100	(66 - 74)

Fig 7, 33, 33.1, 34, 34HP, 36, 36HP, 37, 3616, Fig 3716 and Fig 3616 Food+ Flanged Strainers

**Fig 3616 strainer - Recommended tightening torques**

Item	Qty	Size	 or mm		N m	(lbf ft)
5	4	DN15 and DN20	13 A/F	M8 x 20	15 - 20	(11 - 15)
	4	DN25	13 A/F	M8 x 20	15 - 20	(11 - 15)
	4	DN32 and DN40	13 A/F	M8 x 20	15 - 20	(11 - 15)
	4	DN50	16 A/F	M10 x 25	22 - 25	(16 - 18)
	4	DN65	17 A/F	M10 x 30	22 - 25	(16 - 18)
	6	DN80	17 A/F	M10 x 30	22 - 25	(16 - 18)
	6	DN100	18 A/F	M12 x 35	50 - 60	(37 - 44)
	8	DN125	19 A/F	M12 x 40	50 - 60	(37 - 44)
	8	DN150	19 A/F	M12 x 40	50 - 60	(37 - 44)
	8	DN200	24 A/F	M16 x 50	100 - 110	(74 - 81)

**Fig 3716 strainer - Recommended tightening torques**

Item	Qty	Size	 or mm		N m	(lbf ft)
5	4	DN15 and DN20	13 A/F	M8 x 20	15 - 20	(11 - 15)
	4	DN25	13 A/F	M8 x 20	15 - 20	(11 - 15)
	4	DN32 and DN40	13 A/F	M8 x 20	15 - 20	(11 - 15)
	4	DN50	17 A/F	M10 x 25	22 - 25	(16 - 18)
	4	DN65	17 A/F	M10 x 30	22 - 25	(16 - 18)
	6	DN80	17 A/F	M10 x 30	22 - 25	(16 - 18)
	6	DN100	19 A/F	M12 x 35	50 - 60	(37 - 44)
	8	DN125	19 A/F	M12 x 40	50 - 60	(37 - 44)
	8	DN150	19 A/F	M12 x 40	50 - 60	(37 - 44)
	8	DN200	24 A/F	M16 x 50	100 - 110	(74 - 81)

# 8. Spare parts

The only parts that are available as spares are detailed in the table below.

## Available spares

Strainer screen (state material, mesh, perforation and size of strainer)	4
<b>Note: The Fig 7 pot type is only available with 3.2 mm perforated stainless steel</b>	
Cap gasket (packet of three)	3

## How to order spares

Always order spares by using the description given in the column headed 'Available spares' and state the size and type.

**Example:** 1 off 100 mesh stainless steel screen for a DN100 Fig 34 steel strainer.

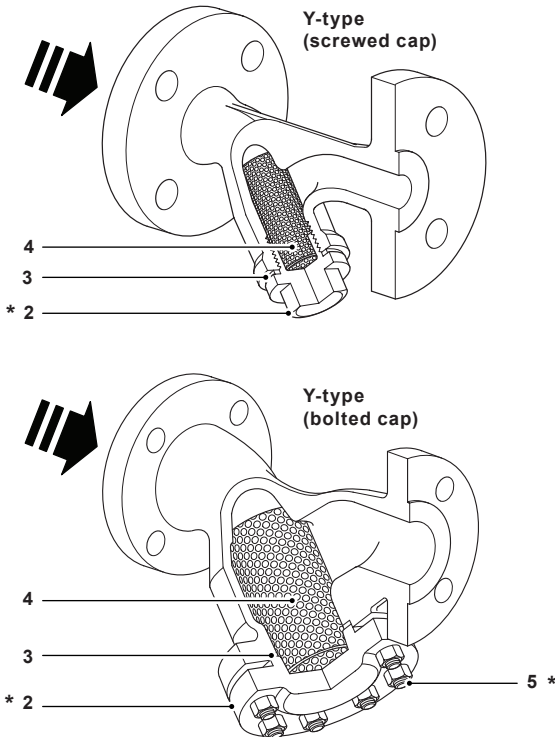

\* **Note:** Items 1, 2, 5, 6 and 7 are annotated for identification of parts relating to the tightening torques on pages 31 to 35.

Fig 7, 33, 33.1, 34, 34HP, 36, 36HP, 37, 3616, Fig 3716 and Fig 3616 Food+ Flanged Strainers



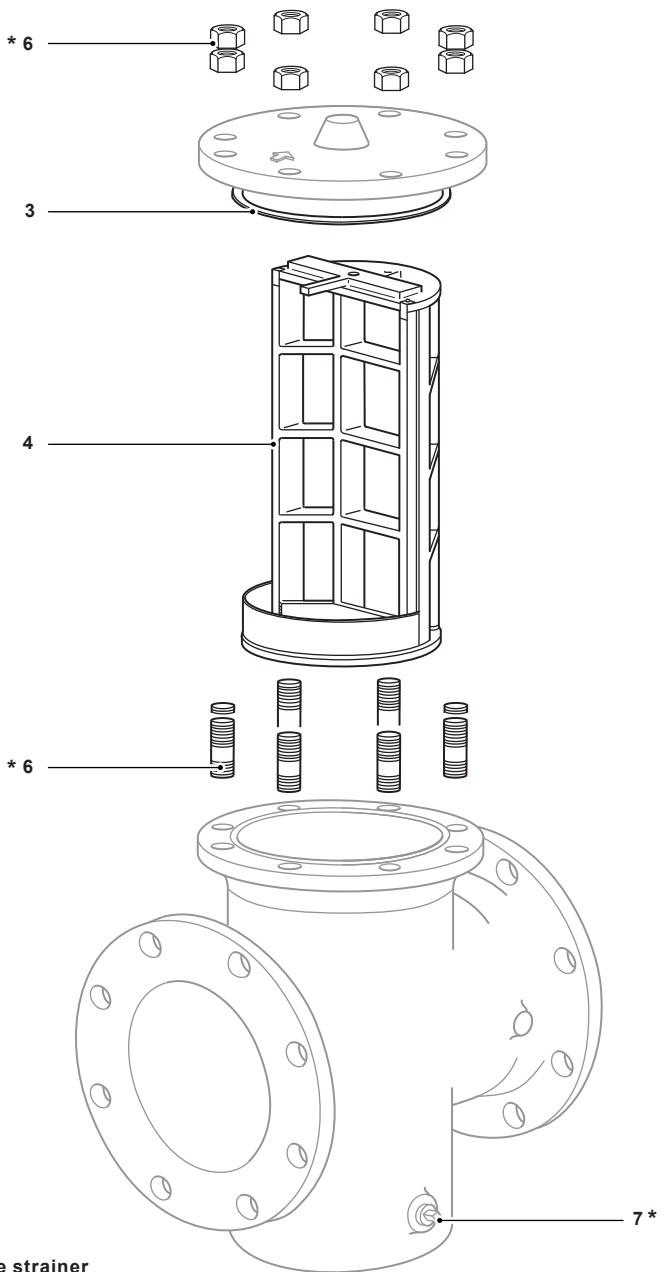

Fig 7 pot type strainer

Fig 7, 33, 33.1, 34, 34HP, 36, 36HP, 37, 3616, Fig 3716 and Fig 3616 Food+ Flanged Strainers

---

Fig 7, 33, 33.1, 34, 34HP, 36, 36HP, 37, 3616, Fig 3716 and Fig 3616 Food+ Flanged Strainers

---

Fig 7, 33, 33.1, 34, 34HP, 36, 36HP, 37, 3616, Fig 3716 and Fig 3616 Food+ Flanged Strainers

---

Fig 7, 33, 33.1, 34, 34HP, 36, 36HP, 37, 3616, Fig 3716 and Fig 3616 Food+ Flanged Strainers