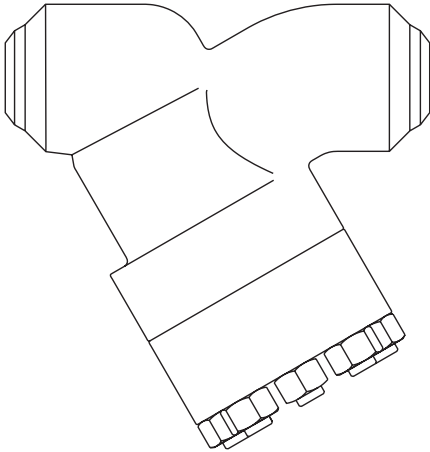

Fig 18HP

Butt weld Strainer

Installation and Maintenance Instructions



1. Safety information
2. General product information
3. Installation
4. Commissioning
5. Operation
6. Maintenance
7. Spare parts
8. Fault finding

Fig 18HP Butt weld Strainer





1. Safety information

Safe operation of this product can only be guaranteed if it is properly installed, commissioned, used and maintained by qualified personnel (see Section 1.11) in compliance with the operating instructions. General installation and safety instructions for pipeline and plant construction, as well as the proper use of tools and safety equipment must also be complied with.

1.1 Intended use

Referring to the Installation and Maintenance Instructions, nameplate and Technical Information Sheet, check that the product is suitable for the intended use / application.

The product listed below complies with the requirements of the EU Pressure Equipment Directive/

UK Pressure Equipment (Safety) Regulations and carry the  /  marks with the Notified Body number when so required.

The product falls within the following Pressure Equipment Directive and Pressure Equipment (Safety) Regulation categories:

Product	Group 1 Gases	Group 2 Gases	Group 1 Liquids	Group 2 Liquids
Fig 18HP	DN15 - DN25	SEP	SEP	SEP
	DN32	2	SEP	2
	DN40 - DN50	2	1	2

- i) This product has been specifically designed for use on air or water/condensate which is in Group 2 gases and liquids of the above mentioned Pressure Equipment Directive. It can also be used on steam, air or water/condensate which is in Group 1 of the Pressure Equipment Directive. The products' use on other fluids may be possible but, if this is contemplated, Spirax Sarco should be contacted to confirm the suitability of the product for the application being considered.
- ii) Check material suitability, pressure and temperature and their maximum and minimum values. If the maximum operating limits of the product are lower than those of the system in which it is being fitted, or if malfunction of the product could result in a dangerous overpressure or overtemperature occurrence, ensure a safety device is included in the system to prevent such over-limit situations.
- iii) Determine the correct installation situation and direction of fluid flow.
- iv) Spirax Sarco products are not intended to withstand external stresses that may be induced by any system to which they are fitted. It is the responsibility of the installer to consider these stresses and take adequate precautions to minimise them.
- v) Remove protection covers from all connections and protective film from all name-plates, where appropriate, before installation on steam or other high temperature applications.
- vi) Prior to use, the user shall ensure the fluid compatibility with the equipment material.

1.2 Access

Ensure safe access and if necessary a safe working platform (suitably guarded) before attempting to work on the product. Arrange suitable lifting gear if required.

1.3 Lighting

Ensure adequate lighting, particularly where detailed or intricate work is required.

1.4 Hazardous liquids or gases in the pipeline

Consider what is in the pipeline or what may have been in the pipeline at some previous time. Consider: flammable materials, substances hazardous to health, extremes of temperature.

1.5 Hazardous environment around the product

Consider: explosion risk areas, lack of oxygen (e.g. tanks, pits), dangerous gases, extremes of temperature, hot surfaces, fire hazard (e.g. during welding), excessive noise, moving machinery.

1.6 The system

Consider the effect on the complete system of the work proposed. Will any proposed action (e.g. closing isolation valves, electrical isolation) put any other part of the system or any personnel at risk?

Dangers might include isolation of vents or protective devices or the rendering ineffective of controls or alarms. Ensure isolation valves are turned on and off in a gradual way to avoid system shocks.

1.7 Pressure systems

Ensure that any pressure is isolated and safely vented to atmospheric pressure. Consider double isolation (double block and bleed) and the locking or labelling of closed valves. Do not assume that the system has depressurised even when the pressure gauge indicates zero.

1.8 Temperature

Allow time for temperature to normalise after isolation to avoid danger of burns.

1.9 Tools and consumables

Before starting work ensure that you have suitable tools and/or consumables available. Use only genuine Spirax Sarco replacement parts.

1.10 Protective clothing

Consider whether you and/or others in the vicinity require any protective clothing to protect against the hazards of, for example, chemicals, high/low temperature, radiation, noise, falling objects, and dangers to eyes and face.

1.11 Permits to work

All work must be carried out or be supervised by a suitably competent person.

Installation and operating personnel should be trained in the correct use of the product according to the Installation and Maintenance Instructions.

Where a formal 'permit to work' system is in force it must be complied with. Where there is no such system, it is recommended that a responsible person should know what work is going on and, where necessary, arrange to have an assistant whose primary responsibility is safety.

Post 'warning notices' if necessary.

Fig 18HP Butt weld Strainer

1.12 Handling

Manual handling of large and/or heavy products may present a risk of injury. Lifting, pushing, pulling, carrying or supporting a load by bodily force can cause injury particularly to the back. You are advised to assess the risks taking into account the task, the individual, the load and the working environment and use the appropriate handling method depending on the circumstances of the work being done.

1.13 Residual hazards

In normal use the external surface of the product may be very hot. If used at the maximum permitted operating conditions the surface temperature of some products may reach temperatures of 538 °C (1000 °F).

Many products are not self-draining. Take due care when dismantling or removing the product from an installation (refer to 'Maintenance instructions').

1.14 Freezing

Provision must be made to protect products which are not self-draining against frost damage in environments where they may be exposed to temperatures below freezing point.

1.15 Disposal

Unless otherwise stated in the Installation and Maintenance Instructions, this product is recyclable and no ecological hazard is anticipated with its disposal providing due care is taken.

1.16 Returning products

Customers and stockists are reminded that under EC Health, Safety and Environment Law, when returning products to Spirax Sarco they must provide information on any hazards and the precautions to be taken due to contamination residues or mechanical damage which may present a health, safety or environmental risk. This information must be provided in writing including Health and Safety data sheets relating to any substances identified as hazardous or potentially hazardous.

Fig 18HP Butt weld Strainer

2. General product information

2.1 General description

The Fig 18HP is an alloy steel butt weld Y-type strainer with flanged screen cover that has been designed in accordance with ASME B16.34:2004 and ASME VIII. The standard stainless steel screen in the DN15 to DN50 size range has 0.8 mm perforations – See Section 2.3 'Optional extras' for alternative perforations / mesh sizes and screen materials. If required, the strainer cover can be drilled and tapped for blowdown and drain valves.

Standards

This product fully complies with the requirements of the EU Pressure Equipment Directive/UK Pressure Equipment (Safety) Regulations and carries the  /  marks when so required.

Certification

This product is available with certification to EN 10204 3.1 and NACE Approval.

Note: All certification/inspection requirements must be stated at the time of order placement.

Note: For additional data see the following Technical Information Sheets: TI-P162-03.

2.2 Sizes and pipe connections

DN15, DN20, DN25, DN32, DN40 and DN50 (½", ¾", 1", 1¼", 1½" and 2")

Screwed BSP (BS21) and NPT (ASME B 1.20.1)

Socket weld ASME B 16.11 and BS 3799

Butt weld ASME B16.25 Schedule 160, Schedule 80 and Schedule 40

2.3 Optional extras

The following optional extras are available for all unit sizes at an extra cost and must be stated at the time of order placement:

Perforations	0.8 mm (standard), 1 mm, 1.6 mm, 3 mm and 6 mm Contact Spirax Sarco for availability of perforations not displayed.
Mesh	M20, M40, M60, M100, M200 and M400 Contact Spirax Sarco for availability of mesh screens not displayed.
Screen material	AISI 316, AISI 316L (standard), AISI 304, AISI 304L and Monel

Blowdown/drain valve connection

The cover can be drilled to the following sizes to enable a blowdown or drain valve to be fitted. This option is available at extra cost.

Strainer	Size	Blowdown valve	Drain valve
Fig 18HP	DN15 - DN25	½"	½"
	DN32 - DN50	1¼"	¾"

Fig 18HP Butt weld Strainer

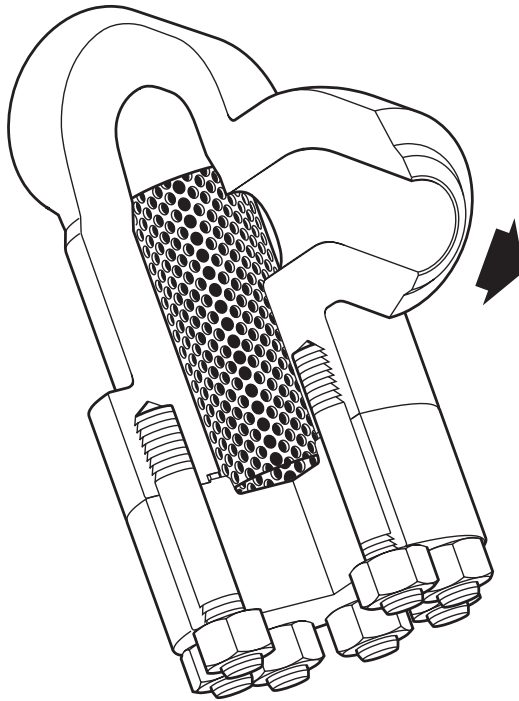
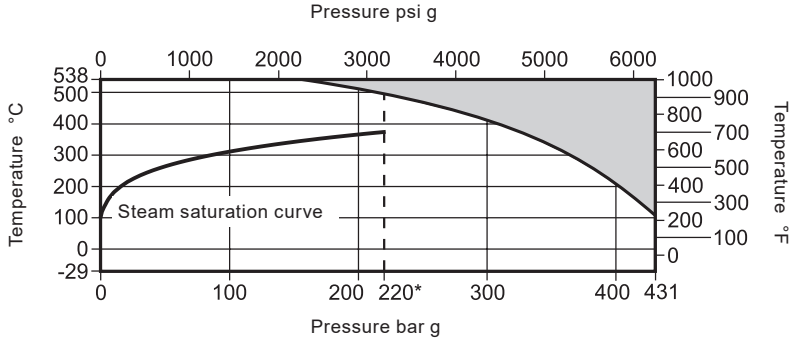

Fig. 1 Fig 18HP, alloy steel, butt weld, Y-type strainer with flanged screen cover

Fig 18HP Butt weld Strainer

2.4 Pressure/temperature limits



The product **must not** be used in this region.

Body design conditions		ASME 2500	
PMA	Maximum allowable pressure	431 bar g @ 38 °C	(6251 psi g @ 100 °F)
TMA	Maximum allowable temperature	538 °C @ 154 bar g	(1000 °F @ 2233 psi g)
Minimum allowable temperature		-29 °C	(-20 °F)
PMO *	Maximum operating pressure for saturated steam service	220 bar g @ 374 °C	(3191 psi g @ 705 °F)
TMO	Maximum operating temperature	538 °C @ 154 bar g	(1000 °F @ 2233 psi g)
Minimum operating temperature		-29 °C	(-20 °F)
Note: For lower operating temperatures consult Spirax Sarco			
Designed for a maximum cold hydraulic test pressure of:		646 bar g	(9369 psi g)

Fig 18HP Butt weld Strainer

2.5 Kv values

Size	DN15	DN20	DN25	DN32	DN40	DN50
perforations 0.8, 1.6 and 3 mm	5	8	13	22	29	46
Mesh M200	4	6	10	17	23	37

If required, please consult Spirax Sarco for the Kv values of the following screens: 1 mm, 6 mm, M20, M40, M60, M100 and M400.

2.6 Dimensions

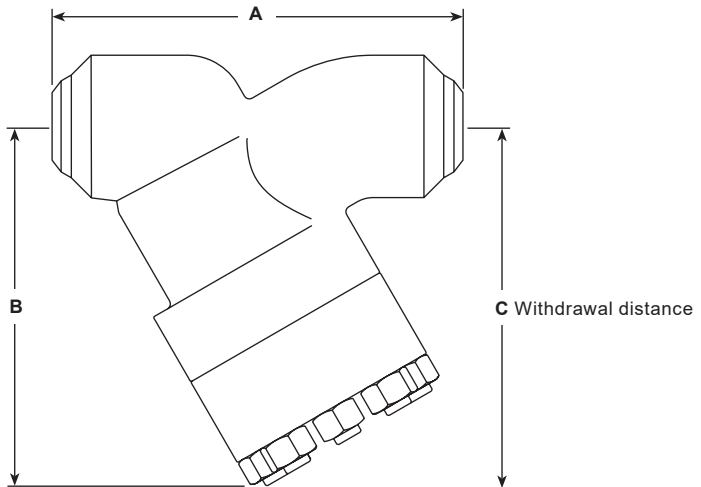

Size	A	B	C	Weight	Volume (L)	Screening area (cm ²)
DN15	180	150	196	8.74	0.130	73 cm ²
DN20				8.79	0.140	
DN25				8.84	0.145	
DN32	280	240	308	28.75	0.850	251 cm ²
DN40				28.82	0.850	
DN50				28.99	0.850	

Fig. 2

Fig 18HP Butt weld Strainer

3. Installation

Note: Before actioning any installation observe the 'Safety information' in Section 1.

Referring to the installation and Maintenance Instructions, name-plate and Technical Information Sheet, check that the product is suitable for the intended installation:

- 3.1** Check materials, pressure and temperature and their maximum values. If the maximum operating limit of the product is lower than that of the system in which it is being fitted, ensure that a safety device is included in the system to prevent overpressurisation.
- 3.2** Determine the correct installation situation and the direction of fluid flow.
- 3.3** Remove protection covers from all connections and protective film from all name-plates, where appropriate, before installation on steam or other high temperature applications.
- 3.4** Strainers can be fitted on liquid or steam/gas systems in either horizontal pipework or vertical pipework where the flow is downward. In a horizontal line on steam/gases the strainer pocket should be in the horizontal plane as this reduces the possibility of waterhammer. On liquid systems the strainer pocket should point downwards.
- 3.5** The strainers may be lagged if required.

4. Commissioning

After installation or maintenance ensure that the system is fully functional. Carry out tests on any alarms or protective devices.

5. Operation

Strainers are passive items and will prevent the onward movement of dirt and debris, which is larger than the holes in the screen. The pressure drop across the strainer will increase as the screen becomes blocked. Regular cleaning / blowdown is recommended to keep the screen clean.

Fig 18HP Butt weld Strainer

Strainer installed on steam or gas

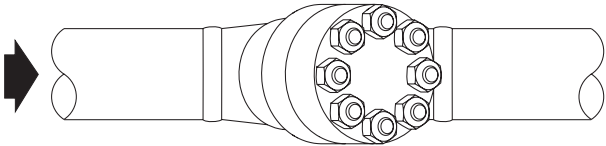

Strainer installed on liquid

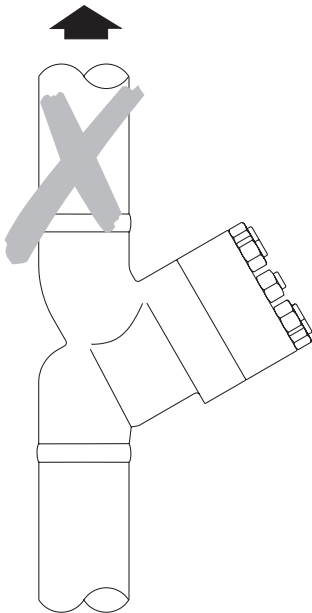
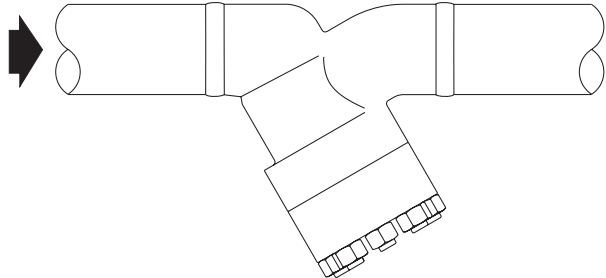

Flow

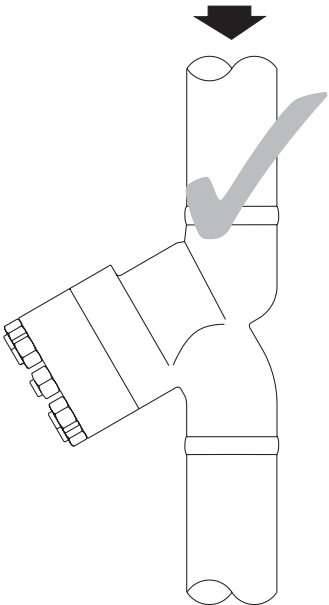

Flow downwards

Fig. 3

Fig 18HP Butt weld Strainer

6. Maintenance

Note: Before actioning any maintenance programme observe the 'Safety information' in Section 1.

Warning

The cover gasket contains a thin stainless steel support ring which may cause physical injury if not handled and disposed of carefully.

6.1 General information

Before undertaking any maintenance on the strainer, it must be isolated from both the supply line and return line and any pressure allowed to safely normalise to atmosphere. The trap should then be allowed to cool. When reassembling, ensure that all joint faces are clean.

6.2 How to clean or replace the strainer screen:

For identification of parts refer to Section 7 'Spare parts'

- Remove the strainer cap (2) by undoing the cover nuts (6) from the cover studs (5). The number of bolts/nuts used will depend on the strainer size, material of construction and design rating.
- Once the cap is removed the strainer screen (4) can be taken out.
- Clean the strainer screen (4) or replace with a new one.
- Reassemble the strainer screen (4) by pushing it into the recess of the cap (2).
- Always fit a new strainer cover gasket (3) ensuring the jointing faces are clean.
- Refit the strainer cover (2) using 'Neverseize' compound on the cover studs and nuts (5 + 6) and tighten. Caution: Ensure that the cover nuts (6) are tightened equally before final torque is applied - See Table 1 for the recommended tightening torque.
- Check for leaks.

Table 1 Recommended tightening torques



Items	Size	Quantity	or		N m	(lbf ft)
						
5 and 6	DN15 - DN25	4	1¼"	¾" - 10 UNC	140 - 150	(104 - 111)
	DN32 - DN50	8	1¼"	¾" - 10 UNC	120 - 130	(89 - 96)

Fig 18HP Butt weld Strainer

7. Spare parts

The spare parts available are shown in solid outline. Parts drawn in a grey line are not supplied as spares.

Available spares

Spares kit 1	Strainer screen and Cover gasket (state material, perforations or mesh and size of strainer)	4 and 3
Spares kit 2	Cover gasket (3 off)	3

How to order spares

Always order spares by using the description given in the column headed 'Available spares' and state the spares kit required plus the size and type of strainer and perforations or mesh required for the screen.

Example: 1 off Spares kit 1 for a DN50 Spirax Sarco Fig 18HP strainer having butt weld connections. The strainer screen is to be stainless steel with 1.6 mm perforations.

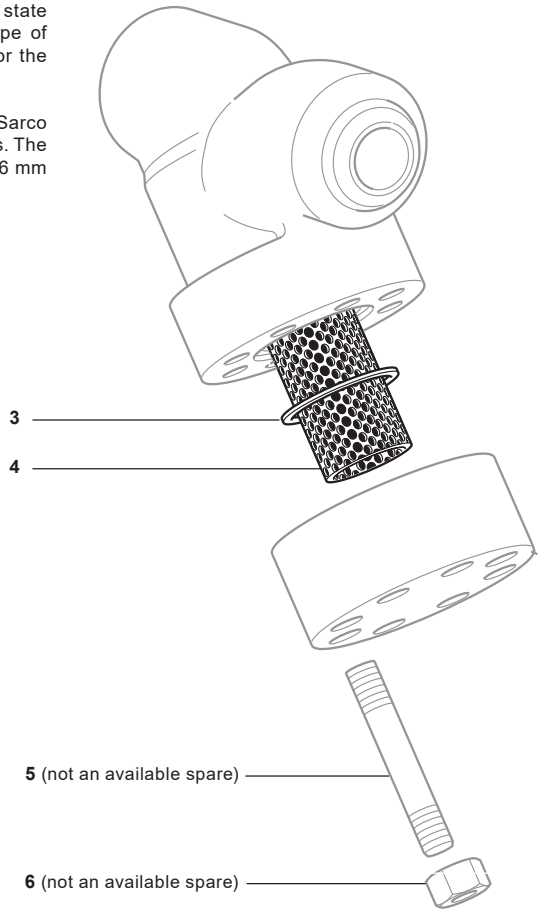

Fig. 4

Fig 18HP Butt weld Strainer

8. Fault finding

Symptom	Possible cause	Remedy
No flow through strainer	Blocked screen	Clean or replace screen See Section 6.2
	System is isolated	Check isolation valves
Increased pressure drop across strainer	Screen is blocked up	Clean or replace screen See Section 6.2

Fig 18HP Butt weld Strainer

Fig 18HP Butt weld Strainer

Fig 18HP Butt weld Strainer

