

AEL8 Series
Electric Linear Actuators
Installation and Maintenance Instructions

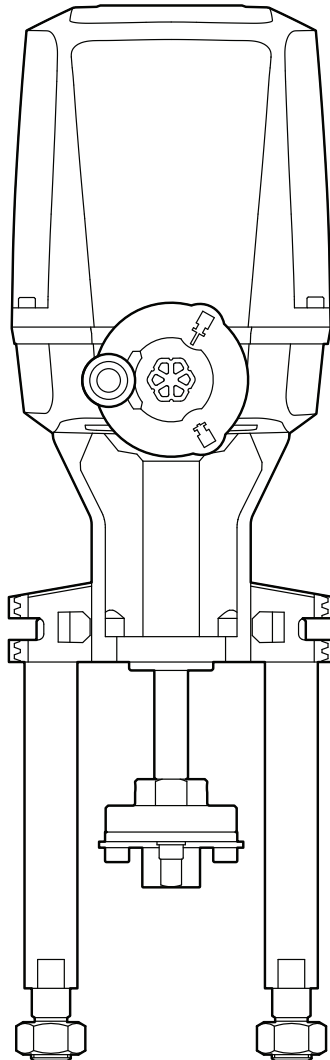

Contents

1.	Safety information	3
2.	General product information	8
3.	Installation	11
4.	Electrical connections	17
5.	Actuator accessories and spares	26
6.	Commissioning	33
7.	Maintenance	43
8.	Declaration of Conformity	50

1. Safety information

Safe operation of this product can only be guaranteed if it is properly installed, commissioned, used and maintained by qualified personnel (see Section 1.19) in compliance with the operating instructions. General installation and safety instructions for pipeline and plant construction, as well as the proper use of tools and safety equipment must also be complied with.

See separate Installation and Maintenance Instructions for the control valve.



If the actuator is handled improperly or not used as specified, the resultant may:

- cause danger of the life and limb of the third party,
- damage the actuator and other assets belonging to the owner,
- hinder the performance of the actuator.

1.1 Wiring notes

Every effort has been made during the design of the actuator to ensure the safety of the user, but the following precautions must be followed:

- i) Maintenance personnel must be suitably qualified in working with equipment containing hazardous live voltages.
- ii) Ensure correct installation. Safety may be compromised if the installation of the product is not carried out as specified in this manual.
- iii) Isolate the actuator from the mains supply before opening the unit.
- iv) The actuator is designed as an installation category II product, and is reliant on the building installation for overcurrent protection and primary isolation.
- v) Wiring should be carried out in accordance with IEC 60364 or equivalent.
- vi) Fuses should not be fitted in the protective earth conductor. The integrity of the installation protective earth system must not be compromised by the disconnection or removal of other equipment.
- vii) A disconnecting device (switch or circuit breaker) must be included in the building installation. This must be in close proximity to the equipment and within easy reach of the operator.
 - There must be a 3 mm contact separation in all poles.
 - It must be marked as the disconnecting device for the actuator.
 - It must not interrupt the protective earth conductor.
 - It must not be incorporated into a mains supply cord.
 - The requirements for the disconnecting device are specified in IEC 60947-1 and IEC 60947-3 or equivalent.
- viii) The actuator must not be located in such a way that the disconnecting device is made difficult to operate.

1.2 Safety requirements and electromagnetic compatibility

This product is  and  marked.

It complies with the requirements of 73/23/EEC as amended by 93/68/EEC on the harmonisation of the law of Member States relating to electrical equipment designed for use within certain voltage limits (LVD), by meeting the standard for safety of electrical equipment for measurement control and laboratory use. This product complies with the requirement of 89/336/EEC as amended by 92/31/EEC and 93/68/EEC on the approximation of laws of the Member States relating to Electromagnetic Compatibility, by meeting the generic standard of emissions for an industrial environment and the generic standard of immunity for an industrial environment. The product may be exposed to interference above the limits of industrial immunity if:

- The product or its wiring is located near to a radio transmitter.
- Excessive electrical noise occurs on the mains supply.
- Cellular telephones and mobile radios may cause interference if used within approximately one metre of the product or its wiring. The actual separation necessary will vary according to the power of the transmitter.
- Power line protectors (ac) should be installed if mains supply noise is likely.
- Protectors can combine filtering, suppression, surge and spike arrestors.

For a copy of the declaration of conformity please see section 8.

1.3 Intended use

Referring to the Installation and Maintenance Instructions, name-plate and Technical Information Sheet, check that the product is suitable for the intended use/application.

- i) Check products suitability to ensure product is suitable in relation to the thrust required to modulate and close the valve. (Refer to TI-P714-01)
- ii) Check that actuator is suitable for the operating environment and insure adequate protection is implemented when required
- iii) Determine the correct installation situation.
- iv) Spirax Sarco products are not intended to withstand external stresses that may be induced by any system to which they are fitted. It is the responsibility of the installer to consider these stresses and take adequate precautions to minimise them.

1.4 Access

Ensure safe access and if necessary a safe working platform (suitably guarded) before attempting to work on the product. Arrange suitable lifting gear if required.

1.5 Lighting

Ensure adequate lighting, particularly where detailed or intricate work is required.

1.6 Hazardous liquids or gases in the pipeline

Consider what is in the pipeline or what may have been in the pipeline at some previous time. Consider: flammable materials, substances hazardous to health, extremes of temperature.

1.7 Hazardous environment around the product

Consider: explosion risk areas, lack of oxygen (e.g. tanks, pits), dangerous gases, extremes of temperature, hot surfaces, fire hazard (e.g. during welding), excessive noise, moving machinery.

1.8 The system

Consider the effect on the complete system of the work proposed. Will any proposed action (e.g. closing isolation valves, electrical isolation) put any other part of the system or any personnel at risk? Dangers might include isolation of vents or protective devices or the rendering ineffective of controls or alarms. Ensure isolation valves are turned on and off in a gradual way to avoid system shocks.

1.9 Pressure systems

Ensure that any pressure is isolated and safely vented to atmospheric pressure. Consider double isolation (double block and bleed) and the locking or labelling of closed valves. Do not assume that the system has depressurised even when the pressure gauge indicates zero.

1.10 Temperature

Allow time for temperature to normalise after isolation to avoid danger of burns.

The actuator must not be insulated. When coupled to a valve operating on high temperature media, if there is a risk of burning through handling (intentional or accidental), it is recommended that suitable methods of prevention are implemented e.g. machine or a visual warning.

1.11 Tools and consumables

Before starting work ensure that you have suitable tools and/or consumables available. Use only genuine Spirax Sarco replacement parts.

1.12 Protective clothing

Consider whether you and/or others in the vicinity require any protective clothing to protect against the hazards of, for example, chemicals, high/low temperature, radiation, noise, falling objects, and dangers to eyes and face.

1.13 Permits to work

All work must be carried out or be supervised by a suitably competent person. Installation and operating personnel should be trained in the correct use of the product according to the Installation and Maintenance Instructions. Where a formal 'permit to work' system is in force it must be complied with. Where there is no such system, it is recommended that a responsible person should know what work is going on and, where necessary, arrange to have an assistant whose primary responsibility is safety. Post 'warning notices' if necessary.

1.14 Handling

Manual handling of large and/or heavy products may present a risk of injury. Lifting, pushing, pulling, carrying or supporting a load by bodily force can cause injury particularly to the back. You are advised to assess the risks taking into account the task, the individual, the load and the working environment and use the appropriate handling method depending on the circumstances of the work being done.

1.15 Safe lifting practice

Never use the actuator to lift a valve. It is recommended to lift the complete valve assembly using the correct equipment(s) and techniques so as not to cause damage or injury. Valves should be supported under the inlet and outlet connections, not the actuator (including hand wheel or accessories), and careful attention should be made to prevent the valve from rotating during the lift sequence. When installed, neither the actuator, valve or its accessories should be used as a hand hold or step for access to other parts of the plant.

1.16 Residual hazards

In normal use the external surface of the product may be very hot. If used at the maximum permitted operating conditions the surface temperature of some products may exceed temperatures of 90 °C (194 °F).

1.17 Disposal

Unless otherwise stated in the Installation and Maintenance Instructions, this product is recyclable and no ecological hazard is anticipated with its disposal providing due care is taken.

- REACH. Should any substances of very high concern be found within a product, details of the location will be identified within the technical information page 4: Materials.

Further information about product compliance is available at:
www.spiraxsarco.com/product-compliance

1.18 Returning products

Customers and stockists are reminded that under EC Health, Safety and Environment Law, when returning products to Spirax Sarco they must provide information on any hazards and the precautions to be taken due to contamination residues or mechanical damage which may present a health, safety or environmental risk. This information must be provided in writing including Health and Safety data sheets relating to any substances identified as hazardous or potentially hazardous.

1.19 Responsibilities of the operator and operating (including maintenance) personnel.

The operator is responsible for ensuring that safe systems of operation and practice are implemented and maintained. Only competent persons must be allowed to be able to operate and maintain these devices, and these persons must be familiar with, and comply with the applicable health and safety standards or guidelines.

The installation and maintenance instructions should form part of the standard operating procedures for maintenance and must therefore be kept in an accessible location and in a legible condition. Product identification and safety related labels must also be kept in a clean and legible condition. Identification and safety labels must be replaced if they become damaged or obscured in operation.

Copyright © Spirax-Sarco Limited 2024

All rights reserved

Spirax-Sarco Limited grants the legal user of this product (or device) the right to use the Work(s) solely within the scope of the legitimate operation of the product (or device). No other right is granted under this licence. In particular and without prejudice to the generality of the foregoing, the Work(s) may not be used, sold, licensed, transferred, copied or reproduced in whole or in part or in any manner or form other than as expressly granted here without the prior written consent of Spirax-Sarco Limited.

2. General product information

2.1 Introduction

The AEL8 series electric linear actuators are only suitable for the use on Spirax Sarco group valves. Refer to TI-P714-01 for product compatibility and linkage requirements. The AEL8 Series actuators must not be used for any other purpose. Actuators will normally be supplied fitted to the control valve. When supplied separately, ensure the actuator selected is capable of providing the force necessary to close the two-port or three-port control valve against the expected differential pressure. See the appropriate product specific Technical Information Sheet for full details of the control valve.

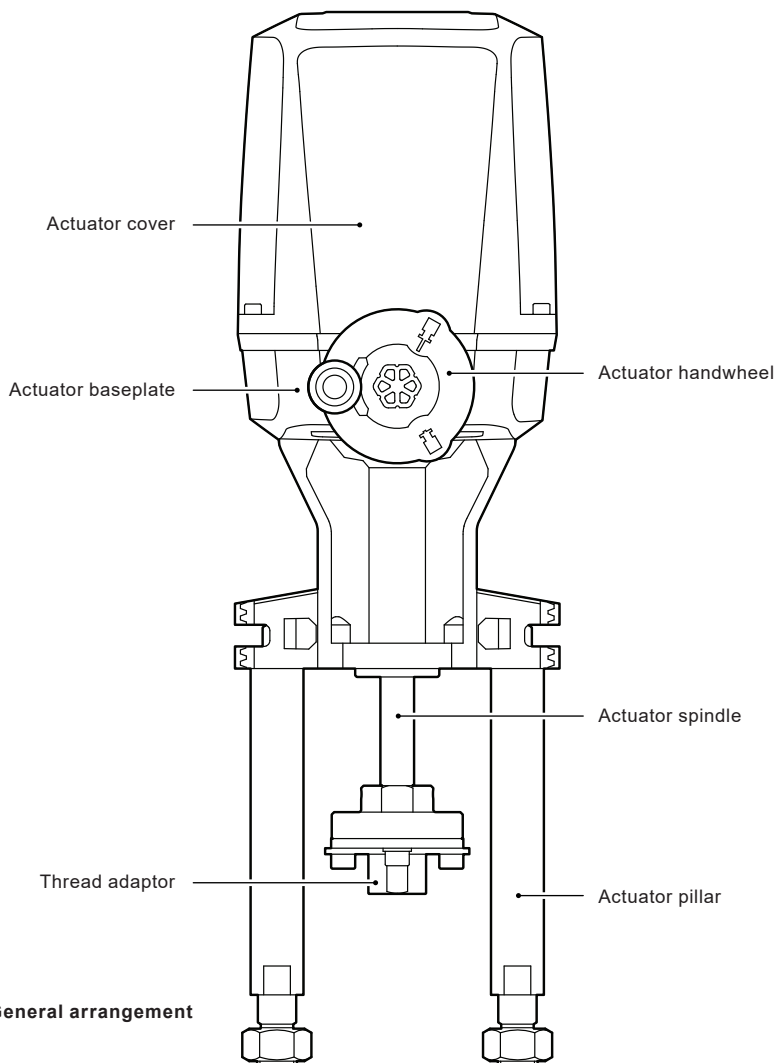

Fig. 1
AEL8 General arrangement

AEL8 Series Electric actuator

2.2 Series in the AEL8 range

Product Name	A	Actuator		A
	E	Electric		E
	L	Linear		L
	8	Model		8
Thrust (kN)	2	2.0 kN		2
	3	4.5 kN		
	4	6.0 kN		
	5	8.0 kN		
	6	12.0 kN		
	7	15.0 kN		
Stroke (mm)	2	60mm		2
	3	80mm		
Speed @ 30%	2	Medium	0.8-1.9 mm/s	2
	3	High	2.0+ mm/s	
Supply voltage	1	90....264 Vac wide range input		3
	3	24 Vac / 24 Vdc		
Control signal	P	Modulating	(0)4-20mA / 0(2)-10V Positioner	P
Failure mode	X	None		S
	S	Super-Capacitor	Non-Retrofit option	
Options	X	None		X
	O	I/O Module		
	E	EasiHeat M12 connectors		

2.3 Operating principle

The AEL8 Series is a range of linear electric actuators of various voltages and thrusts suitable for the modulation of Spirax Sarco Group valves by means of modulating signal. Independent of the control method, the actuators typically uses two electro-mechanical force dependent (torque) switches to determine the end position of the actuator stroke in both directions and stop the actuator motor i.e. uses the end stops within the valve in order to determine stroke. The force dependent switches do not require any adjustment to correspond to valves with different lengths of stroke.

The positioner card can be set locally to accept various input control signals. The position feedback signal automatically defaults to match the input signal.

The shutdown module when fitted can drive the actuator to either an open or closed position. A 24 Vdc input signal can also be used to drive an actuator to a safe end stop position.



Caution

The shutdown module consists of a factory fitted supercapacitor system. This module can drive the valve to a safe position as identified by a process risk assessment.

Important

The shutdown module is NOT a safety device. A safety device should always operate independently of the control device. Please contact Spirax Sarco for further guidance.

3. Installation

Before considering installation of an AEL8 Series actuator please read to Section 1 "Safety Information" on page 2.



Installation awareness

- Lifting and fitting of actuators increases the risk of personal injury
- Mains connection and commissioning of the AEL8 Series actuator requires specialist knowledge of electrical circuits and systems, and the inherent dangers. A working knowledge of linear actuators is also required.
- Risk of injury by moving parts. Ensure that the control system is disabled and the electrical power supply is isolated to ensure that the valve and actuator do not move without warning.
- The incorrect use of power supplies to assist the installation, commissioning and maintenance of electrically actuated valve assemblies increases the risk of personal injury.
- Lifting and fitting of actuators increases the risk of personal injury.

Crush hazard

When actuators are to be fitted using lifting equipment always ensure that the actuator is carefully slung in order that it cannot fall. Never attempt to remove a control valve from the line by using the actuator as the lifting point. The actuator or the lifting equipment could become damaged.

Never stand under components that are being lifted. Head safety protection must always be worn when operating on or close to equipment where lifting operations are taking place.

Do not place hands within the actuator yoke or on the stem when isolation of the electrical power supply has been removed.

Do not attempt to restrict actuator stroke or movement, or increase seat load through the placing of objects within the actuator yoke. This practice could also result in the loss of sight.

Warning - Muscular skeletal damage

For small actuators that do not require mechanical lifting aids, always ensure that manual lifting best practice is observed. Always use two personnel where possible and ensure that proper access is available in order to ensure a secure foothold.



The valve body and pipeline that the AEL8 is installed in, must be sufficiently lagged to prevent any heat transfer to the actuator.

Failure to do this will result in a reduced product life. For further information please refer to "Effects on product life due to temperature graph" in TI-P714-01.

3.1 Location

The actuator should be mounted above the valve and provide sufficient space to remove the cover and provide general ease of access. When selecting the location, make sure that the actuator is not exposed to an ambient temperature exceeding the range -20 °C to + 60 °C (-20 °C to +50 °C for actuators fitted with the shutdown module). All actuators have an enclosure protection rating of IP65, but only when the cover is correctly fitted (see Section 3.3).

Adequate shelter and an anti-condensation heater must be provided for outdoor installations. For internal installations where there is a risk of condensation an anti-condensation heater should also be installed.

Refer to Technical Information Sheet TI-P714-01 for details.

3.2 Operational considerations – Handwheel function and operation

The handwheel of the AEL8 provides two functions. The primary function is the manual operation of the actuator for installation, commissioning or manual override of the control valve assembly. The hand wheel is connected to the gearbox mechanism by a clutch and therefore does not move under normal operating conditions.



Caution

Always take note of the operating direction of the hand wheel in relation to the required direction of spindle movement. Failure to observe the correct direction of operation could result in damage to actuator or process.



Caution

Do not operate the hand wheel when the actuator is either moving or connected to a live control system. Both of these actions could lead to damage to the actuator and injury to the operator.

To operate the hand wheel, press the hand wheel to the second detent toward the actuator. The hand wheel will illuminate blue to identify manual mode engaged. Maintaining this pressure and simultaneously turning of the hand wheel will cause actuator movement:

- Clockwise extends the actuator spindle (closes Spira-trol™ 2-port valve)
- Anti-clockwise retracts the actuator spindle (opens Spira-trol™ 2-port valve)

Releasing the pressure on the hand wheel with a light pull will disengage the hand wheel clutch from the actuator gearbox, and the hand wheel will no longer be illuminated blue.

The second function of the actuator hand wheel is as a diagnostic tool See Section 6.3 for details.

3.3 Coupling the actuator to a valve

The operator is responsible for ensuring that safe systems of operation and practice are implemented and maintained. Only competent persons must be allowed to couple the AEL8 Series actuator to a valve, and these persons must be familiar with, and comply with the applicable health and safety



Caution

It is possible to damage the force dependent switches by applying excessive load by use of the hand wheel.

- Some valve and actuator combinations will require additional valve adapters and linkage kits. Consult TI-P714-01 to ensure you have the correct valve and actuator for your application.
- Remove the actuator retaining nut from the valve and place the mounting flange over the valve bonnet thread.
- Refit the actuator retaining nut and tighten (50 Nm for M34 or 100 Nm for M50).
- Remove the actuator pillar nuts. Using the hand wheel or hand crank, retract the actuator spindle by approximately 50% of valve stroke to ensure that the valve is coupled with the plug away from the seat in order to prevent valve damage.
- Untighten the four screws and remove the valve adapter locking plate and valve adapter bush from the actuator.
- Place the locking plate over the valve stem.
- Set the valve stem lock nut at the correct Thread Engagement dimension "A" (Figure 3 and Tables on page 15 and 16) for the relevant valve and actuator combination.
- Lift the actuator over the valve stem and place onto the mounting flange and loosely refit the actuator pillar nuts raise the valve plug to the actuator until the threaded bush meets the actuator coupling.



Caution

Before the pillar nuts are tightened, make sure that the pillar ends are completely inserted into the bores of the valve mounting flange. If necessary, correct the position of the actuator using the hand wheel.

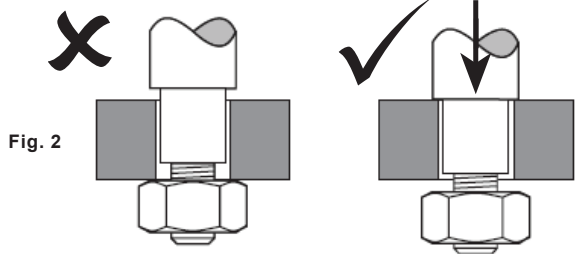

Fig. 2

Using the hand wheel, lower the actuator stem until it touches the valve adaptor.

With the valve adapter and actuator spindle aligned correctly and with the plug off the valve seat:

- Couple the adapter locking plate
- Tighten the pillar nuts to 30 Nm
- Tighten the 4 valve adaptor screws to 8 Nm
- Tighten the thread lock nut to 15 Nm

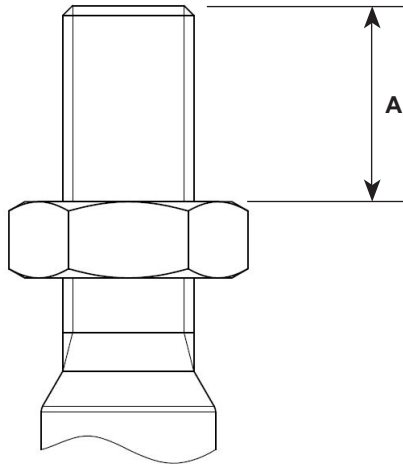

Fig 3. Thread engagement

AEL8 Valve adaptor and mounting flange selection - Spira-trol™ K & L

Actuator	Thrust	DN15 - DN50			
		Flange	Thread	Adapter	Engagement (A)
AEL82	2.0 kN	EL5970	M8	AEL8 X M8 ¹	12 mm
AEL83	4.5 kN				
AEL84	6.0 kN				15 mm
AEL85	8.0 kN				
AEL86	12.0 kN				
AEL87	15.0 kN				

Actuator	Thrust	DN65 - DN100			
		Flange	Thread	Adaptor	Engagement (A)
AEL82	2.0 kN	EL5971	M12	Integral	19 mm
AEL83	4.5 kN				
AEL84	6.0 kN				
AEL85	8.0 kN				
AEL86	12.0 kN				
AEL87	15.0 kN				

¹ Included in the standard scope of supply AEL82 to AEL85

AEL8 Valve adaptor and mounting flange selection - QLM & QLD

Actuator	Thrust	DN15 - DN50			
		Flange	Thread	Adapter	Engagement (A)
AEL82	2.0 kN	EL5970 ³	M8	AEL8 X M8 ¹	12 mm
AEL83	4.5 kN				
AEL84	6.0 kN				15 mm
AEL85	8.0 kN				
AEL86	12.0 kN				
AEL87	15.0 kN				

Actuator	Thrust	DN65 - DN100			
		Flange	Thread	Adapter	Engagement (A)
AEL82	2.0 kN	EL5971	M12	Integral	19 mm
AEL83	4.5 kN				
AEL84	6.0 kN				
AEL85	8.0 kN				
AEL86	12.0 kN				
AEL87	15.0 kN				

Actuator	Thrust	DN125 - DN200			
		Flange	Thread	Adapter	Engagement (A)
AEL82	2.0 kN				
AEL83	4.5 kN				
AEL84	6.0 kN				
AEL85	8.0 kN	EL5974	M18 x 1.5	AEL8XQ18 + AEL8Q125 ¹	28 mm
AEL86	12.0 kN				
AEL87	15.0 kN				

¹ Included in the standard scope of supply AEL82 to AEL85

² Adapter must be ordered separately

³ Spacer 3570003 also required

4. Electrical connections

4.1 Electrical connections safety information



Caution

Before commencement of any work to make the electrical connections please read Section 1 "Safety Information".



Warning

Mains connection and commissioning of the AEL8 Series actuator requires specialist knowledge of electrical circuits and systems, and the inherent dangers. A working knowledge of linear actuators is also required.

The operator is responsible for ensuring that safe systems of operation and practice are implemented and maintained. Only qualified personnel must be allowed to make the electrical power connections to the AEL8 Series actuator, and these personnel must be familiar with, and comply with the applicable health and safety standards or guidelines. Failure to do so could result in death, severe physical injuries or material damages to the actuator, valve and associated equipment.

- Ensure that the electrical power supply is isolated
- Safeguard against the unintentional switching on by ensuring that there is a safe system of practice in operation – e.g. lock the electrical supply isolator
- Ensure that any installation of any new power supply is compliant with local regulations
- Check the mains connection voltage and frequency for conformity to the actuator. Details of the requirements are identified on the AEL8 Series actuator nameplate which can be found on the actuator baseplate
- Ensure that the power supply cable is of the correct cross Section for the maximum expected load. Details of the requirements are identified on the AEL8 Series actuator nameplate which can be found on the actuator baseplate, and in the Technical Information Sheet (TI-P714-01)
- Minimum cross Section for the power supply cable is 1 mm². Conductors below this area can result in operational disturbances (please note maximum cable core size 2.5 mm² for 2-6 kN actuators.
- Ensure that the power supply is correctly fused for the maximum expected load. Details of the requirements for each AEL8 Series actuator can be found in Tables on pages 18 to 21.

AEL8 Actuator power consumption – 100-240 Vac

Actuator Nomenclature	Thrust	Spindle Speed	Power consumption (W)	Nominal current (A)
AEL82221PXX	2 kN	1.6 mm/s	29	0.13
AEL82221PSX			59	0.26
AEL82221PXO			29	0.13
AEL82221PSO			59	0.26
AEL83221PXX	4.5 kN	1.6 mm/s	45	0.2
AEL83221PSX			59	0.26
AEL83221PXO			45	0.2
AEL83221PSO			59	0.26
AEL83231PXX		4.5 mm/s	112	0.49
AEL83231PSX			112	0.49
AEL83231PXO			45	0.2
AEL83231PSO			112	0.49
AEL84221PXX	6 kN	1.2 mm/s	45	0.2
AEL84221PSX			59	0.26
AEL84221PXO			45	0.2
AEL84221PSO			59	0.26
AEL84231PXX		3.6 mm/s	112	0.49
AEL84231PSX			112	0.49
AEL84231PXO			112	0.49
AEL84231PSO			112	0.49

AEL8 Actuator power consumption – 100-240 Vac

Actuator nomenclature	Thrust	Spindle speed	Power consumption (W)	Nominal current (A)
AEL85321PXX	8 kN	1.0 mm/s	50	0.22
AEL85321PSX				
AEL85321PXO				
AEL85321PSO				
AEL85331PXX		3.0 mm/s	108	0.47
AEL85331PSX				
AEL85331PXO				
AEL85331PSO				
AEL86321PXX	12 kN	1.4 mm/s	88	0.38
AEL86321PSX				
AEL86321PXO				
AEL86321PSO				
AEL86331PXX		3.0 mm/s	241	1.1
AEL86331PSX				
AEL86331PXO				
AEL86331PSO				
AEL87321PXX	15 kN	1.0 mm/s	108	0.47
AEL87321PSX				
AEL87321PXO				
AEL87321PSO				
AEL87331PXX		2.0 mm/s	241	1.1
AEL87331PSX				
AEL87331PXO				
AEL87331PSO				

AEL8 Actuator power consumption – 24V

Actuator Nomenclature	Thrust	Spindle Speed	Power consumption (W)	Nominal current (A)
AEL82223PXX	2 kN	1.6 mm/s	29	1.2
AEL82223PSX			59	2.5
AEL82223PXO			29	1.2
AEL82223PSO			59	2.5
AEL82223PXE			29	1.2
AEL83223PXX	4.5 kN	1.6 mm/s	45	1.9
AEL83223PSX			59	2.5
AEL83223PXO			45	1.9
AEL83223PSO			59	2.5
AEL83233PXX		4.5 mm/s	112	4.7
AEL83233PSX			112	4.7
AEL83233PXO			112	4.7
AEL83233PSO			112	4.7
AEL83233PXE			112	4.7
AEL83233PXE			112	4.7
AEL84223PXX	6 kN	1.2 mm/s	45	1.9
AEL84223PSX			59	2.5
AEL84223PSX			45	1.9
AEL84223PXO			59	2.5
AEL84233PXX		3.6 mm/s	112	4.7
AEL84233PSX			112	4.7
AEL84233PXO			112	4.7
AEL84233PSO			112	4.7

AEL8 Actuator power consumption – 24V

Actuator nomenclature	Thrust	Spindle speed	Power consumption (W)	Nominal current (A)
AEL85323PXX	8 kN	1.0 mm/s	50	2.1
AEL85323PSX				
AEL85323PXO				
AEL85323PSO				
AEL85333PXX		3.0 mm/s	108	4.5
AEL85333PSX				
AEL85333PXO				
AEL85333PSO				
AEL86323PXX	12 kN	1.4 mm/s	88	3.7
AEL86323PSX				
AEL86323PXO				
AEL86323PSO				
AEL86333PXX		3.0 mm/s	241	10
AEL86333PSX				
AEL86333PXO				
AEL86333PSO				
AEL87323PXX	15 kN	0.9 mm/s	108	4.5
AEL87323PSX				
AEL87323PXO				
AEL87323PSO				
AEL87333PXX		2.0 mm/s	241	10
AEL87333PSX				
AEL87333PXO				
AEL87333PSO				

4.1 Removing the actuator cover

The AEL8 Series actuator cover is secured to the actuator housing by 4-off M6 socket cap-head screws. A 3 mm hex key is required to remove these screws. Each screw is held into the actuator cover with an 'O' ring to prevent loss. Once all screws are loosened, the actuator cover can be removed without interference.



Note

When replacing the cover ensure that the actuator housing seal is fully inserted in its location. Gently lower the actuator cover until it meets the ingress seal. Firmly press down the actuator cover to identify that the seal is correctly inserted before tightening the retaining screws.
Screws should be tightened to 10 Nm

4.2 Making the electrical connection

A terminal diagram for the actuator can be found inside the actuator cover and Figure 4 of this Installation and Maintenance Instructions.

The operator is responsible for ensuring that safe systems of operation and practice are implemented and maintained, and the installation and maintenance instructions should form part of the standard operating procedures for maintenance and must therefore be kept in an accessible location, and in a legible condition.

With the actuator coupled to a valve as described in Section 3, the actuator spindle in the fully extended position, the power supply safely isolated and the actuator cover removed:

- Remove the blanking plate and fit the correct cable gland for the location. Any removed blanking plates must be recycled or disposed of responsibly.
- Feed the electrical power supply cable through the cable gland until enough length exists within the actuator to make all of the necessary connections easily.
- Mark the power supply cable approximately 10 mm above the actuator base plate, remove from the gland and carefully strip the outer casing and wrapping. Dispose of the waste responsibly.
- Strip the individual cores at a length of approximately 5mm from the end, and once the correct lengths of the individual cores have been established, It is best practice for the ends to have correctly sized flat or pin type insulated crimps and where possible this process should be followed.
- Guide the cores of the power supply cable through the gland sleeve and gland, and connect the cores to the actuator terminals as identified in the terminal diagrams below (or in the hood of the actuator) taking care to ensure that the routing of the cores protects them from damage of moving parts or from damage when replacing or removing the actuator cover.

4.3 Electrical connection

Please refer to Figure 4 for all AEL8 electrical connections unless otherwise stated.



Power supply			Position override			Modulating signal		
						Setpoint		
1	2		46	51	53	59	57	56
-	-		-	▲	▼	▲▼	-	▲▼
N	L	PE	N	+	+	mA+	GND	V+
Power Supply (N / 24 VDC -)	Power supply (L / 24 VDC +)	Earth	Ground for Position Override	24Vdc Direction Open	24Vdc Direction Close	Control Input 0(4) – 20 mA	Ground	Control Input 0(2) – 10V

Fig 4.

	<p>Note</p> <p>Terminals: 1 - N,  - PE, 57 - GND and 58 - GND must all be galvanically isolated.</p>
---	--

			Options						
Position feedback			I/O Module				Heater		
60	58	61	54	12	15	45	7	8	
▲▼	-	▲▼	-	▲	▼	-	-	-	
mA+	GND	V+	L	(NO)	(NO)	(NO)	L	N	
Active position feedback mA	Ground	Active position feedback V	24V AC/DC I/O Module supply	stem fully retracted End position feedback	stem fully extended End position feedback	Fault relay	Heater		

5. Actuator accessories and spares

5.1 Actuator accessory safety information



Caution

Before commencement of any work to inspect, install, commission, remove or modify any of the AEL8 Series actuator accessories, please read to Section 1 "Safety Information" and Section 4.1 "Electrical Connection Safety Considerations".

5.2 Actuator accessory selection

To select the correct accessories for each actuator, refer to Table 1. AEL8 Actuator Spares and Accessories.

Although possible to retrofit, it is recommended that the positioner card and I/O module are ordered fitted from the factory. The shutdown module (super capacitors) is not available for retro-fit.

5.2.1 AEL8 accessories

Actuator Type	Thrust	Voltage	I/O Module	Positioner	Heater
AEL8	2 - 6 kN	230Vac	AEL8981	AEL8961	AEL8954
		110Vac			AEL8956
		24Vac			
		24Vdc			
	8 - 15 kN	230Vac			
		110Vac			AEL8965
		24Vac			
		24Vdc			

5.3 Positioner electronics card

The AEL8 series actuator is equipped with a Positioner Electronics Card that provides:

- Modulating control functionality
- Auto-stroke commissioning feature
- 0(2)-10V or (0)4-20mA control input
- Position feedback – automatically corresponds to input signal type (V or mA)

AEL8 series actuators are only available with the Positioner Electronics Card installed as standard. This is to ensure accurate setpoint control at the elevated spindle speeds.



Caution

Before commencement of any work to inspect, install, commission, remove or modify the Positioner Electronics Card, please read to Section 1 "Safety Information" and Section 4.1 "Electrical Connection Safety Considerations".

5.3.1 Positioner electronics card replacement



Note

All following actions must be performed with the actuator spindle in the fully extended position, the power supply safely isolated and the actuator cover removed. If possible, lay the actuator on its side as seen in the images below.

5.3.2 Positioner electronics card removal

- Use a 5.5mm hexagonal socket screwdriver to remove the 2 hexagonal studs located in diagonally opposite corners of the board, and set them aside.
- - Remove the male connector of the cable harness from the board connecting the Positioner card to the I/O module and remove board carefully and set aside (note: it is important the board is kept clean).

5.3.3 Re-installing the positioner electronics card

- Carefully align the Positioner Card Board on top of the spacers as indicated in Figure 5 carefully press firmly down until you feel the board clip onto the plastic barbed spacers.
- Recover the hexagonal studs and using the 5.5mm socket screwdriver carefully secure the board in place.
- Connect wiring harness as indicated in Figure 5 (note: there is a locating nose on the wiring harness to ensure correct orientation, this is on the same side as the red wire).

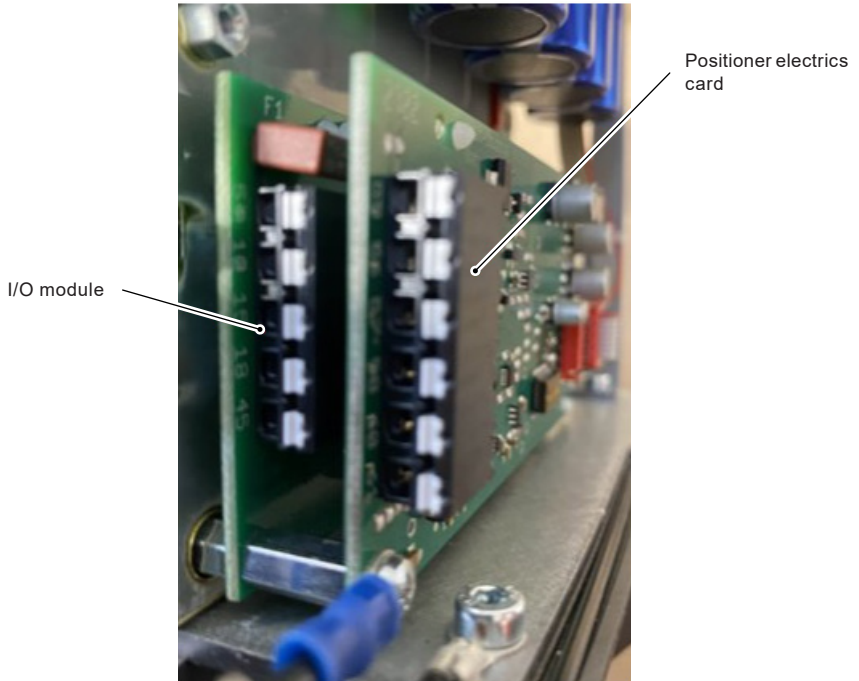

Fig. 5 PEL Orientation

5.4 I/O Module

The AEL8 series actuator can be equipped with an I/O module that provides:

- Normally Open (NO) VFC for end position indication
Automatically sets at limitation of the valve during the auto-stroke procedure
- Diagnostic Fault Relay
Normally Open (NO) VFC to provide indication of actuator fault



Caution

Before commencement of any work to inspect, install, commission, remove or modify the AEL8 I/O Module, please read to Section 1 "Safety Information" and Section 4.1 "Electrical Connection Safety Considerations".

5.4.1 I/O Module Installation



Note

All following actions must be performed with the actuator spindle in the fully extended position, the power supply safely isolated and the actuator cover removed. If possible, lay the actuator on its side as seen in the images below.

With the actuator spindle in the fully extended position, the power supply safely isolated and the actuator cover removed:

- Remove the Positioner Card carefully as instructed in Section 5.3.1
- Using a 5.5 mm hexagonal socket remove the hexagonal studs from the I/O card and set aside.
- The I/O module is mounted upon 2 barbed plastic spacers located diagonally opposite each other. Carefully pull the board in an upward direction from the opposite side to the wired connection, then do the same for the other side. (If the actuator is in an upright position pull the board towards you instead of upwards).
- Disconnect wiring harness connecting the I/O Module to the main board and remove the board.
- To install the new I/O module follow the above instructions in reverse.

5.5 Anti-condensation heater

The anti-condensation heater is used as protection against the formation of condensation within the actuator cover in the case of:

- Strongly varying ambient temperatures
- High air humidity
- Outdoor application

The anti-condensation heater is an automatic device containing a thermostat and therefore does not require commissioning. The thermostat operates with a switch-on temperature of +40 °C and a switch-off temperature of +60 °C.



Caution

Before commencement of any work to inspect, install, commission, remove or modify the AEL8 Anti-Condensation Heater, please read to Section 1 "Safety Information" and Section 4.1 "Electrical Connection Safety Considerations".



Warning

The anti-condensation heater can become very hot and easily burn. Care should be taken, gloves worn and the heater allowed sufficient time to cool before handling.

5.5.1 Anti-condensation heater installation

With the actuator spindle in the fully extended position, the power supply safely isolated and the actuator cover removed:

- Check the anti-condensation heater kit for completeness and signs of damage. Reject any damaged parts immediately
- Carefully align the anti-condensation heater as indicated in Figure 6 (Anti-Condensation Heater Orientation) and screw to the actuator baseplate with the screws provides (Max. 2Nm)
- Connect wires as indicated in Figure 4.



Fig. 6 Heater Orientation

6. Commissioning

6.1 Commissioning safety information



Caution

Before commencement of any commissioning works, please read to Section 1 "Safety Information" and Section 4.1 "Electrical Connection Safety Considerations".



Warning

Mains connection and commissioning of the AEL8 Series actuator requires specialist knowledge of electrical circuits and systems, and the inherent dangers. A working knowledge of linear actuators is also required.

Risk of injury by moving parts. Ensure that the control system is disabled and the electrical power supply is isolated to ensure that the valve and actuator do not move without warning.

The incorrect use of power supplies to assist the installation, commissioning and maintenance of electrically actuated valve assemblies increases the risk of personal injury.

Warning – crush hazard

Do not place hands within the actuator yoke or on the stem when isolation of the electrical power supply has been removed.

Do not attempt to restrict actuator stroke or movement, or increase seat load through the placing of objects within the actuator yoke. This practice could also result in the loss of sight.

6.2 Commissioning of positioner electronics card



Caution

It is possible to damage the force dependent switches by applying excessive load by use of the hand wheel.

The positioner card is fitted with a series of DIP switches that can be used to configure:

- Input signal
- Feedback signal
- Direction of action
- Failure mode (loss of control signal only)
- Seating (commissioning) function



Note

For split range applications, please contact Spirax Sarco.

Push button assignment

PROG	Programming button / Save button
+	Movement retracting (to open valve)
-	Movement extracting (to close valve)
AUTO	Switchover MANUAL/AUTO

Light emitting diodes (LEDs)

L_P	Orange
L_+	Red
L_-	Green
L_A	Blue
L_Power	Green LED showing PCB is powered

DIP switches

S1	DIP switch row S1
S2	DIP switch row S2

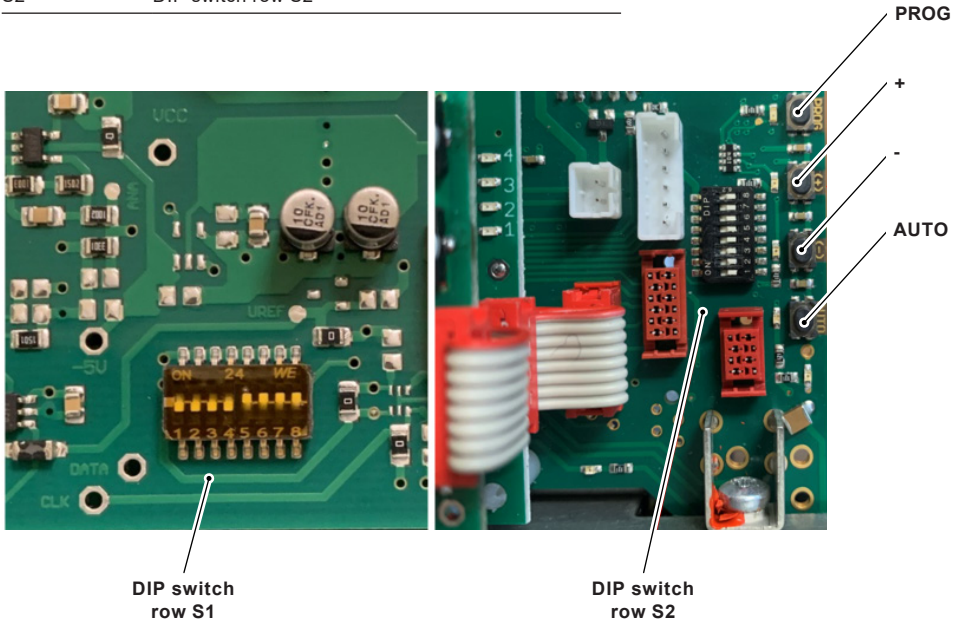

(DIP switches shown as sent from factory, please refer to Section 6 for commissioning)

Fig. 7 Positioner Electronics Card

Table 2 Operation and parameter setting

Push Button	LED	Function
PROG	Orange	Programming button / Save button
UP	Red	Movement - actuator spindle extending
DOWN	Green	Movement - actuator spindle retracting
HAND	Blue	Switchover - Manual / Auto

DIP Switch	LED	Function
S1	N/A	Signal, seating and control configuration
S2		Tuning, calibration and shutdown

	<p>Note The setting of DIP switches will be updated after power on or reset by simultaneously pressing HAND+UP+DOWN+PROG buttons.</p>
---	--

DIP Switch Function:

The DIP switches can be used to set functions directly, without programming. By definition the extended stem of actuator means (Spira-trol™) valve CLOSE and retracted stem of actuator means (Spira-trol™) valve OPEN. The function of the DIP switches is described below.

DIP Switch SW.1 Configuration

Switch No.	Function	OFF	ON
S1.1	Not in use		
S1.2	Reversing signal	0% CLOSE	0% OPEN
S1.3	0% position	4-20 mA / 2-10V	0-20 mA / 0-10V
S1.4	Reduced force	Off*	Set
S1.5	End position configuration (seating)	See Table on page 36	
S1.6			
S1.7	Position in case of input signal interruption	See Table on page 36	
S1.8			

DIP Switch SW.2 Configuration (On main board)

Switch No.	Function	OFF	ON
S2.1	Calibration of travel	Off*	Set
S2.2	Not in Use		
S2.3	Not in Use		
S2.4	Actuator run in remote mode	Off*	Set
S2.5	Position in case of power supply interruption	See Table below	
S2.6			
S2.7	Autotune Function	Off*	On
S2.8	Use preset stroke for autotune function	Off*	On

End position configuration (seating)

In Case of Input Signal Interruption	S1.5	S1.6
Limit / Limit	Off	Off
Thrust / Limit	On	Off
Limit / Thrust	Off	On
Thrust / Thrust	On	On

Position in case of input signal interruption

In Case of Input Signal Interruption	S1.7	S1.8
0% Position	Off	Off
Close	On	Off
Open	Off	On
Stay in place	On	On

Position in case of power supply interruption

In Case of Input Signal Interruption	S2.5	S2.6
Setpoint	Off*	Off*
Close	On	Off
Open	Off	On
Stay in place	On	On

* Default position

Examples - S1 signal interruption

Note: All examples bellow are configurations

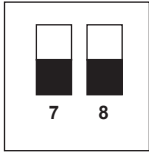

Position in case of signal input interruption in this configuration is fail in place.

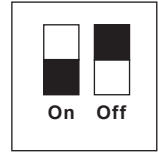

DIP switch key

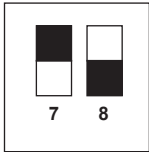

Position in case of signal input interruption in this configuration is fail closed.

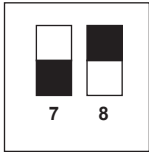

Position in case of signal input interruption in this configuration is fail open.

Examples - S2 Power interruption

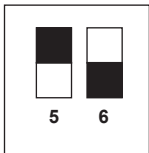

Switch configuration for the actuator to fail open in case of power interruption.

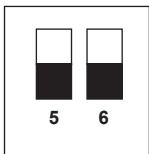

Switch configuration for the actuator to fail in place in case of power interruption.

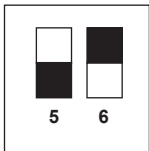

Switch configuration for the actuator to fail close in case of power interruption.

Default configuration

S1

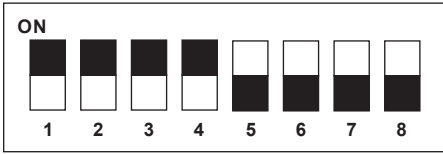

S2

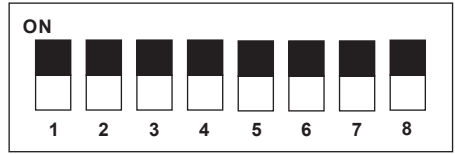

Standard default switch configuration out of box. For safety reasons S2.5 is switched off. This prevents the actuator from closing in the case of a power interruption.

Autotune functionality

S1

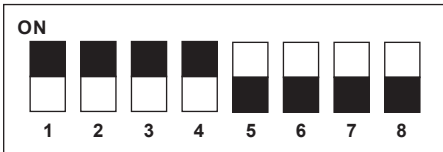

S2

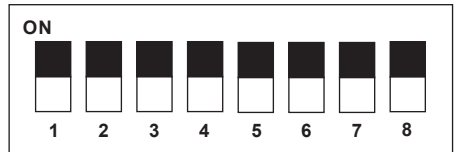
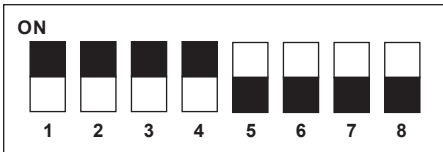
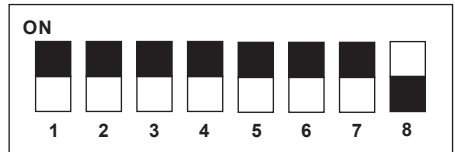

Switch configuration for autotune (S2.8 needs to be up/on to allow autotune to function and returned to down/off upon completion of the autostroke).

6.3 AUTOTUNE – Quick set-up

For the majority of applications a quick set-up routine can be adopted. With the actuator spindle in the fully extended position, the power supply safely isolated and the actuator cover removed:

- With reference to Tables on page 36 (DIP Switch Configuration)
- Select the action required with S1.2 (default is actuator stem extended at minimum input signal)
- Ensure S1.1 is "Off"
- Select the control signal required with S1.5 (default is 4-20 mA / 2-10V) – Note: the feedback signal from the positioner automatically updates to the chosen input signal
- Select the desired failure mode(s) in the event of control signal and power supply interruption. For Steam systems, it is recommended that DIP Switches S1.7, S1.8, S2.5 and S2.6 be set to "OFF" (Tables on page 36)
- Manually move the valve off its seat approximately 20-50%

	<p>Warning The AUTOTUNE function will cause the valve and actuator to move. Make certain that all outcomes have been properly accounted for. The AUTOTUNE function can be stopped by pressing and holding any button during the commissioning cycle.</p> <p>Warning Prior to commissioning actuators fitted with the Shutdown Module, it is important to refer to Section 6.7: Commissioning of Shutdown Module.</p>
---	--

- Reconnect power supply
- Set S2.8 to "ON" and the PROG LED will flash
- Press and hold PROG button for 3 seconds, AUTOTUNE will commence

Commissioning LED status

LED				Status
BLUE	RED	GREEN	ORANGE	
			Flash	Waiting for AUTOTUNE start
	Flash (alternate)		Flash	AUTOTUNE in progress
		Flash		AUTOTUNE complete
	Quick Flash			AUTOTUNE error

- Once AUTOTUNE is complete the illuminated hand wheel will also confirm actuator status (Green if control signal is connected.)
- Set S2.8 to "OFF"

Illuminated handwheel – Actuator status

Colour of handwheel	Status
GREEN	Ready for operation
BLUE	Manual operation (handwheel engaged)
ORANGE	Warning (e.g. actuator operating at 50% speed)
RED	Fault

6.4 Setting stroke manually

Sometimes it may be necessary to set the stroke of the actuator, e.g. to limit the opening of an oversized valve.

With the actuator spindle in the fully extended position, the power supply safely isolated and the actuator cover removed:

- Manually move the valve off its seat approximately 20-50%



Warning

The Stroke setting function will cause the valve and actuator to move. Make certain that all outcomes have been properly accounted for. The Stroke setting function can be stopped by removing pressure to the UP and DOWN button during the commissioning cycle.

Warning

Prior to commissioning actuators fitted with the Shutdown Module, it is important to refer to Section 6.7: Commissioning of Shutdown Module.

- With reference to Tables on page 36 (DIP Switch Configuration)
- Reconnect power supply
- Set S2.1 to "ON"
- Move the actuator spindle to the desired extend end position by using the DOWN button
- Save the extend position by pressing and holding PROG and DOWN buttons simultaneously for 3 seconds
- Move the actuator spindle to the desired retract end position by using the UP button
- Save the retract position by pressing and holding PROG and UP buttons simultaneously for 3 seconds
- Set S2.1 to "OFF"

6.5 Commissioning of I/O module

Once installed and connected in accordance with Figure 6, the I/O Module does not require to be commissioned independently.

LEDs on the I/O Module indicate when the Normally Open contacts are operating at stroke limits.

6.6 Commissioning of anti-condensation Heater

Once installed and connected in accordance with Section 5.5.1, the Anti-Condensation Heater does not require to be commissioned independently.

6.7 Commissioning of shutdown module

The Shutdown Module is commissioned from positioner electronic card. Refer to Section 6.2 for details.



Note

The Shutdown Module supercapacitor store takes approx. 3 minutes to charge. The PROG LED on the positioner electronics card will flash as the capacitor is charging. Once fully charged, the PROG LED will be constantly illuminated.

For commissioning, it is recommended to configure the actuator to fail in place in the event of power or signal failure by setting DIP Switches SW.1.7, SW.1.8, SW.2.5 and SW.2.6 to ON. This allows actuator commissioning to continue without risk of unwanted movements by setting the actuator to fail in place in the event of an interruption to control signal or power supply.

Once commissioning is complete, configure DIP Switches SW.1.7, SW.1.8, SW.2.5 and SW.2.6 to determine the failure mode of the actuator in operation



Caution

Super-capacitors can take up to 60 minutes to discharge.

Every precaution should be taken to NOT touch the shutdown module circuit board. However in the event that contact is made, the capacitor terminals may cause an electric shock or damage to the actuator.

6.8 24V Position override

The AEL8 position override function allows the valve to be moved to a safe position by an independent 24V control input. The position override input takes priority over the applied control input signal. Typical uses include independent high limit function of a domestic hot water heat exchanger. Typical source of power is the DCS system or a unique power supply.



Caution

The AEL8 series actuator is NOT a designated "Safety Device" and it must NOT be used as a single point of failure or protection. The actuator can however be configured as part of a safe system whereby it can be modulated to a safe position for the process.

The Position Override function facilitates the actuator to move the valve to a safe position (open or closed) as determined by risk assessment.

Important.

When the position override signal is removed, the actuator will respond according to the applied control input. It is the responsibility of the installer to ensure that the control system meets with required safe systems of practice in the event that this return to operation is not deemed safe.

Therefore it is always recommended that AEL8 Series actuators configured to use the Position Override function are equipped with an I/O Module in order to indicate the valve has reached its physical "safe" position and the control system architecture configured accordingly.

Once connected in accordance with Figure 4, the 24V Position Override is not required to be commissioned independently.

7. Maintenance

7.1 Maintenance safety information



Caution

Before commencement of any maintenance of the AEL8 Series actuator, please read to Section 1 "Safety Information". And Section 4.1 "Electrical Connection Safety Considerations".

Always read the Safety Information Sections of the relevant Installation and Maintenance Instructions for the control valve and any accessories, as well as the actuator before commencing any work.



Warning

Always ensure that the control valve is isolated and all necessary risk assessments and method statements have been validated and authorized prior to commencing maintenance operations.

Mains connection and maintenance of the AEL8 Series actuator or control valve requires specialist knowledge of electrical circuits and systems, and the inherent dangers. A working knowledge of linear actuators and control valves is also required.

Risk of injury by moving parts. Ensure that that the control system is disabled and the electrical power supply is isolated to ensure that the valve and actuator do not move without warning.

The incorrect use of power supplies to assist the installation, commissioning and maintenance of electrically actuated valve assemblies increases the risk of personal injury.

Lifting and fitting or actuators increases the risk of personal injury.



Warning – crush hazard

When actuators are to be fitted using lifting equipment ALWAYS ensure that the actuator is carefully slung in order that it cannot fall. NEVER attempt to remove a control valve from the line by using the actuator as the lifting point. The actuator or the lifting equipment could become damaged.

Never stand under components that are being lifted. Head safety protection must always be worn when operating on or close to equipment where lifting operations are taking place.

Do not place hands within the actuator yoke or on the stem when isolation of the electrical power supply has been removed.

Do not attempt to restrict actuator stroke or movement, or increase seat load through the placing of objects within the actuator yoke. This practice could also result in the loss of sight.

Warning – muscular skeletal damage

For small actuators that do not require mechanical lifting aids, always ensure that manual lifting best practice is observed. Always use two personnel where possible and ensure that proper access is available in order to ensure a secure foothold.

7.2 General maintenance of actuator

The AEL8 is a low maintenance actuator. Routine or periodic maintenance is not required under normal operational demands.

The following parts can be replaced in the event of a break-down. Please refer to the relevant Section of this document for details:

- I/O module
- Positioner electronics card
- Anti-condensation heater

Elastomer sealing elements can be subject to deterioration and should be inspected at regular intervals and replaced if necessary.

7.3 AEL8 diagnostics

The AEL8 has a self-status diagnostic LED that facilitate problem root cause analysis. Identification of error or operation is identified in Table.

Commissioning LED status

LED				Status
BLUE	RED	GREEN	ORANGE	
				Actuator in automatic mode
C				Manual operation by push button
F				Manual operation by hand wheel
	C			Spindle moving to CLOSE
	F			End position CLOSE reached
		C		Spindle moving to OPEN
		F		End position OPEN reached
			F	Shutdown module installed and charging or DIP switch 2.8 / 2.1 on
			C	Shutdown module completely charged
			QF	Shutdown module in operation - actuator moves to a defined position
		QF	QF	Shutdown module unable to operate
			QF	Cable breakage - actuator moves to a defined position
	QF	QF	QF	Actuator thrust exceeded
	F		QF	Critical temperature reached - speed reduced to 50%
	QF		QF	Maximum temperature reached - actuator stop until temperature = Max.T - 20k
		QF	QF	Power supply low
	C	QF	QF	No movement of actuator to CLOSE
	QF	C	QF	No movement of actuator to OPEN
	F	QF	QF	Actuator out of limits

Key

	LED not illuminated
C	Continuous light
F	Flashing
QF	Quick flashing

7.4 Warranty, repair and spare parts

The AEL8 Series actuator is supplied with 36 month warranty from date of manufacture or 24 months in operation (whichever is soonest). The warranty is for the defective manufacture and assembly of the actuator. Failures as a result of poor installation of the actuator, the valve or as a result of poor system design and maintenance are outside of the scope of this warranty. Damage as a result of handling, improper repair works, negligence or chemical and electro-chemical influences are also out of the scope of any warranty consideration.

In the rare event that an actuator should fail in operation, please contact your local Spirax Sarco Sales office for product return instructions.

The AEL8 Series actuator should not be repaired in the field. In the rare event that the AEL8 Series actuator should need to be repaired, the actuator must be returned to the factory with a full field failure report.

Spare parts that are not listed in Section 7.2 for the actuator are only available when assembled by the factory in Germany. Please contact your local Spirax Sarco Sales office for product return instructions.

7.5 Removing the actuator from the valve



Caution

Before commencing to remove an actuator from a valve, please read to Section 1 "Safety Information", Section 4.1 "Electrical Connection Safety Considerations", Section 3.3 "Coupling and Actuator to a Valve" and Section 6 "Commissioning".



Caution

Warning if the shutdown module is installed the actuator can still operate when power supply is disconnected.

Indication that the shutdown module is fully discharged is indicated when all LEDs and health check hand wheel are off.

Sometimes it may be necessary to remove the actuator from the valve for general valve maintenance or to replace the actuator itself. With the actuator spindle in approximately the mid-stroke position, the power supply safely isolated and the actuator cover removed:

- Disconnect the power supply and control signal cable cores from the respective terminals (label for identification if not already done so)
- Loosen the cable gland nut(s) and carefully slide the power supply and control signal cables through the gland(s)
- Make safe the loose cables in case of accidental power restoration
- Loosen the valve adapter and remove the clamp plate
- Loosen the pillar nuts and remove the actuator from the valve

To return or replace the actuator to the valve, refer to Section 3.3 "Coupling the Actuator to a Valve".
To commission the actuator, refer to Section 6. "Commissioning".

7.6 Problem solving

Observation	Possible cause
Actuator does not move	Supply voltage interrupted or isolated
	Supply fuse blown
	Control signal out of range
	Motor failure
	Gearbox failure
	Actuator at maximum operational temperature
Supply fuse blows	Incorrectly sized fuse
	Incorrectly sized wire
	Poor cable connection within the actuator
	Exposed cable cores within the actuator
"Valve does not achieve full stroke 0%"	Incorrect control signal
	Actuator incorrectly coupled to valve
	Interference or blockage within valve
	Positioner Electronic Card incorrectly commissioned
	Position override in operation
	Failure mode set to a position other than 0%
"Valve does not achieve full stroke 100%"	Incorrect control signal
	Actuator incorrectly coupled to valve
	Interference or blockage within valve
	Positioner Electronic Card incorrectly commissioned
	Position override in operation
	Failure mode set to a position other than 100%
"Actuator moving continuously (hunting)"	Poor PID set-up
	Oversized control valve
	Positioner override function activated frequently (hi-limit)

Visually checking the voltage of the shutdown module

The top of the shutdown module has 2 LEDs which give the user a visual indication of the amount of power that is in the supercapacitors.

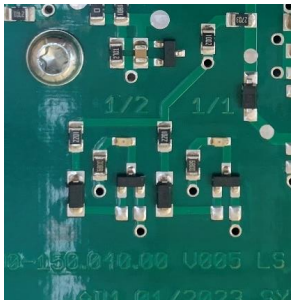
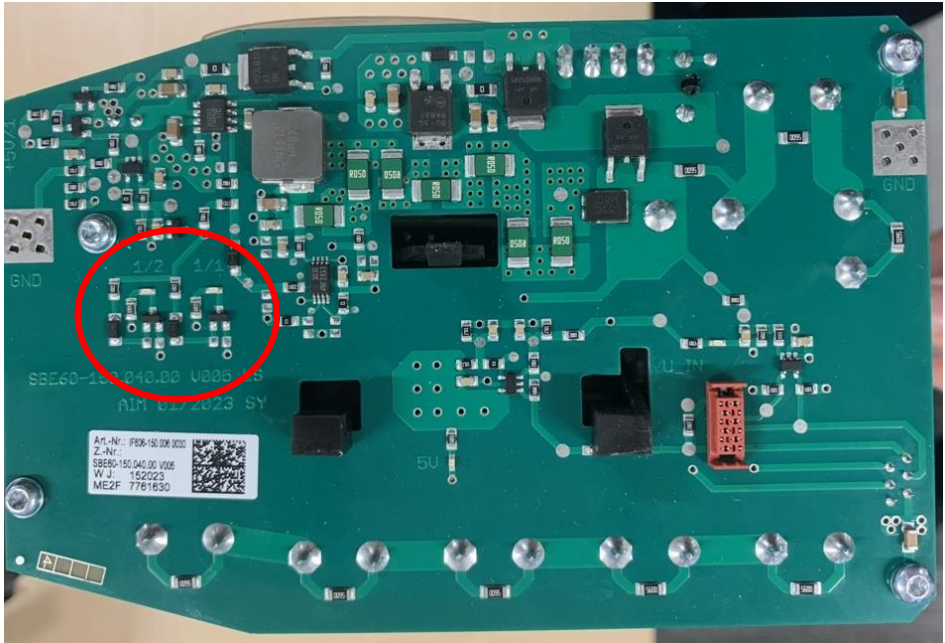

If no LEDs are illuminated the supercapacitors are below 50% charge.
Below 50% is less than 10.3 V



If no LEDs are illuminated the supercapacitors are below 50% charge.
Below 50% is less than 10.3 V

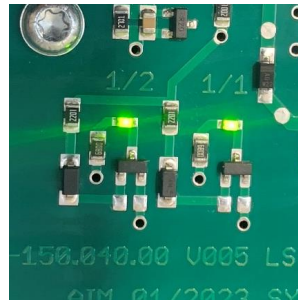

If no LEDs are illuminated the supercapacitors are below 50% charge.
Below 50% is less than 10.3 V

Measuring points of voltages on the shutdown module.

To measure the voltage of the supercapacitors, using a multimeter place the positive and negative probes as shown below:

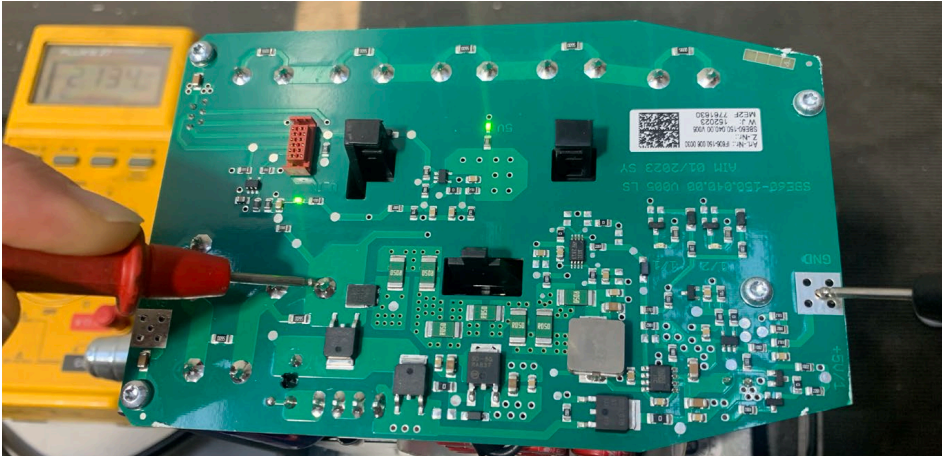

Please note, voltage must be greater than 21 V for operation.

To measure the voltage after the rectifier place the multimeter probes as shown in the image below:

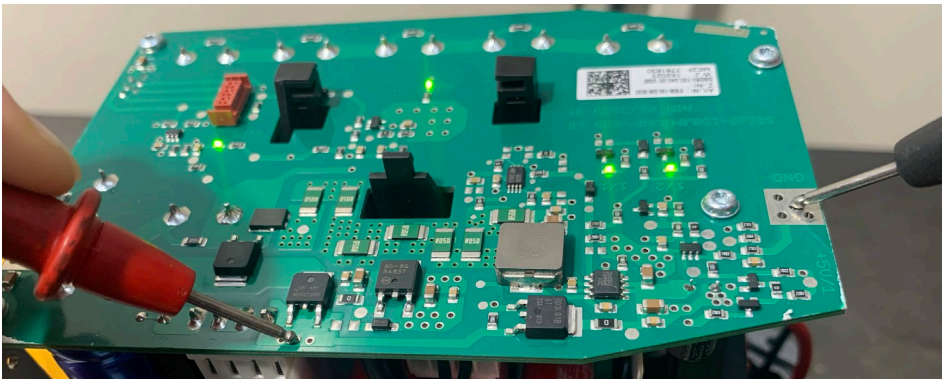

Note, the measured voltage is DC. When using 24 Vac as input power supply the measured voltage will be approximately 33.8 Vdc.

8. Declaration of Conformity

spiraxsarco.com

spirax sarco EN

EU DECLARATION OF CONFORMITY

Apparatus model/Product: **Electric Linear Actuators:
AEL8 Series**

Name and address of the manufacturer or his authorised representative: **Spirax Sarco Ltd,
Runnings Road
Cheltenham
GL51 9NQ
United Kingdom**

This declaration of conformity is issued under the sole responsibility of the manufacturer.

The object of the declaration described above is in conformity with the relevant Union harmonisation legislation:

2014/35/EU	Low Voltage Directive
2014/30/EU	EMC Directive
2006/42/EC	Machinery Directive
(Annex I clauses)	1.1.2, 1.1.3, 1.1.5, 1.2.1, 1.2.2, 1.2.6, 1.3.1, 1.3.2, 1.3.7, 1.5.1, 1.7.3, 1.7.4

References to the relevant harmonised standards used or references to the other technical specifications in relation to which conformity is declared:

(Low Voltage Directive) EN 61010-1:2010+A1:2019
EN IEC 61010-2-202:2021

(EMC Directive) EN 61800-3:2004+A1:2012

(Machinery Directive) EN ISO 12100:2010

Signed for and on behalf of: **Spirax Sarco Ltd,**

(signature):



(name, function): **N Morris
Compliance Manager, Steam Business Development Engineering**

(place and date of issue): **Cheltenham
2023-06-30**

GNP252-CE-C issue 1

AEL8 Series Electric actuator

spirax sarco

DECLARATION OF CONFORMITY

Apparatus model/Product: **Electric Linear Actuators:
AEL8 Series**

Name and address of the manufacturer or his
authorised representative: **Spirax Sarco Ltd,**
Runnings Road
Cheltenham
GL51 9NQ
United Kingdom

This declaration of conformity is issued under the sole responsibility of the manufacturer.

The object of the declaration described above is in conformity with the relevant statutory requirements of:

SI 2016 No.1101 *	The Electrical Equipment (Safety) Regulations 2016
SI 2016 No.1091 *	The Electromagnetic Compatibility Regulations 2016
SI 2008 No.1597 * (Annex I clauses)	The Supply of Machinery (Safety) Regulations 2008 1.1.2, 1.1.3, 1.1.5, 1.2.1, 1.2.2, 1.2.6, 1.3.1, 1.3.2, 1.3.7, 1.5.1, 1.7.3, 1.7.4

(*As amended by EU Exit Regulations)

References to the relevant designated standards used or references to the other technical specifications in relation to which conformity is declared:

SI 2016 No.1101 *	EN 61010-1:2010+A1:2019 EN IEC 61010-2-202:2021
SI 2016 No.1091 *	EN 61800-3:2004+A1:2012
SI 2008 No.1597 *	EN ISO 12100:2010

Additional information:

Signed for and on behalf of: **Spirax Sarco Ltd,**
(signature): 

(name, function): **N Morris**
Compliance Manager
Steam Business Development Engineering

(place and date of issue): **Cheltenham** **30 June 2023**

GNP252-UK-C issue 1

